



**User Manual**

**English**

## **APC Smart-UPS®**

**2200 VA  
120/230 Vac**

**3000 VA  
100/120/208/230 Vac**

**2U Rack Mount  
Uninterruptible Power Supply**



## Introduction

The APC Uninterruptible Power Supply (UPS) is designed to prevent blackouts, brownouts, sags, and surges from reaching your equipment. The uninterruptible power supply (UPS) filters small utility line fluctuations and isolates your equipment from large disturbances by internally disconnecting from the utility line. The UPS provides continuous power from its internal battery until the utility line returns to safe levels or the battery is fully discharged.

## 1: INSTALLATION

### Unpack

Read the Safety Guide before installing the UPS. The User Manual and Safety Guide are accessible on the supplied User Manuals CD and on the APC web site, [www.apc.com](http://www.apc.com).

Inspect the UPS upon receipt. Notify the carrier and dealer if there is damage.

The packaging is recyclable; save it for reuse or dispose of it properly.

Check the package contents:

- UPS
- Front bezel
- Rail kit
- UPS literature kit containing:
  - Smart-UPS® User Manuals CD
  - 120/208/230 V Models Only: PowerChute® CD, Serial and USB communication cables
  - Product documentation, safety and warranty information
  - Rack mounting brackets
  - EPO Connector
  - Hardware
- 230 V Models Only:
  - Input power cord
  - Alternate input power cord  
*UK customers*
  - Utility connector plug
  - IEC Jumper cords

### Rail Installation

Install the rails following the instructions in the rail kit.

### Placement of the UPS

The UPS is heavy. Select a location sturdy enough to handle the weight.

Do not operate the UPS in excessive dust or in temperature and humidity outside the specified limits.

#### PLACEMENT

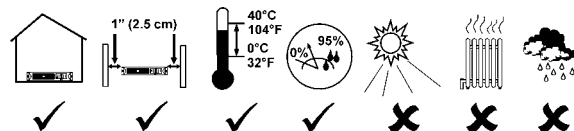

## Mount the UPS in a Rack

Your UPS model may vary from the examples depicted in this manual.

- 1 Install brackets as shown, or at a 5 in (12.7 cm) setback.
- 2 Remove the battery module to lighten the UPS during installation. Note: The module is heavy.

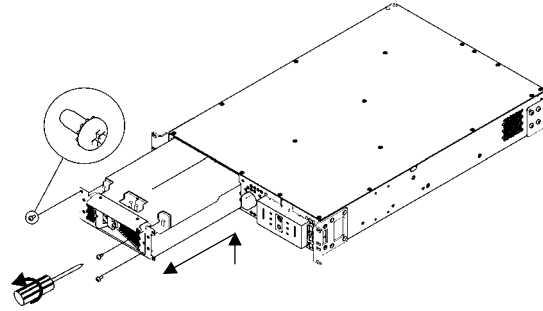
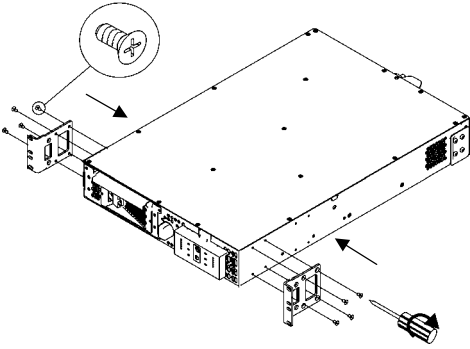

- 3 Install the UPS at or near the bottom of the rack.

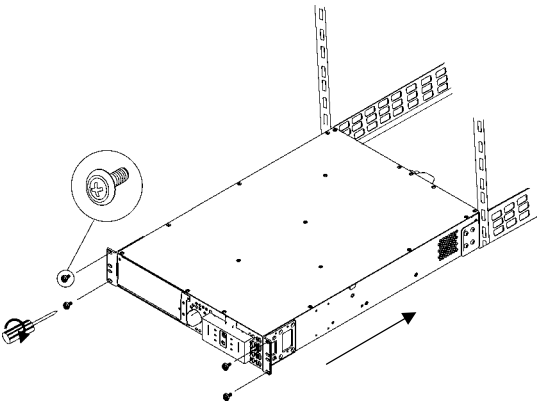

- 4 Reinstall the battery module.

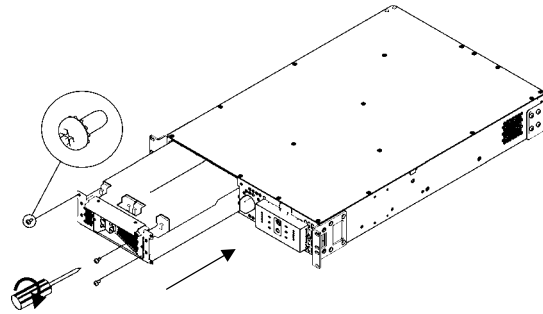

- 5 Connect the battery module.

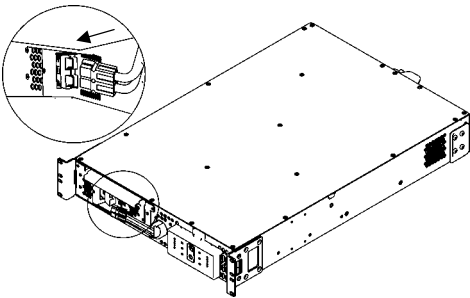

- 6 Attach the front bezel.

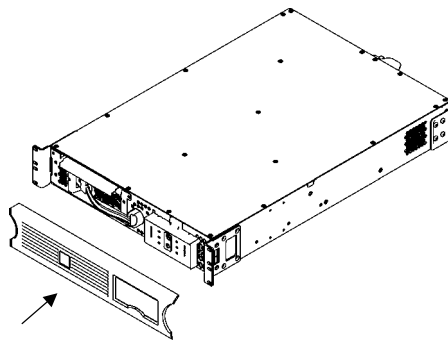



## Connect Equipment and Power to the UPS

### Startup

1. Connect equipment to the UPS. A laser printer draws significantly more power than other types of equipment and may overload the UPS.
2. Add optional accessories to the Smart-Slot.
3. Plug the UPS into a two-pole, three-wire, grounded receptacle only. Avoid using extension cords.

*230 V model:* The power cord is supplied in the UPS cable kit. The TVSS ground, located on the rear panel of the UPS must be connected prior to connecting the utility power.

4. *120 V model:* Check the *site wiring fault* LED  located on the rear panel. It will be illuminated if the UPS is plugged into an improperly wired utility power outlet, (see *Troubleshooting*).
5. Turn on all connected equipment. To use the UPS as a master *on/off* switch, be sure all connected equipment is on.
6. Press the  button on the front panel to power the UPS.
  - The battery charges to 90% capacity during the first four hours of normal operation. **Do not** expect full battery run capability during this initial charge period.
7. For optimal computer system security, install PowerChute Smart-UPS monitoring software.

### Rear Panels

#### 100/120 V

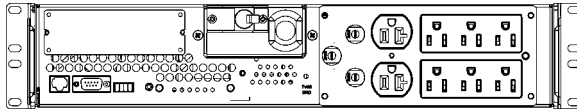

#### 208 V

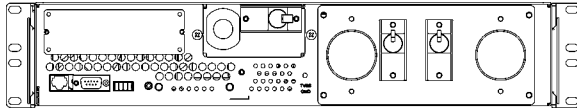

#### 230 V

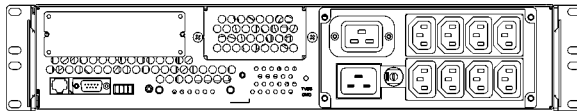

## Basic Connectors

Serial  
Port

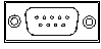

USB  
Port



TVSS  
Screw



Use only interface kits approved by APC.

Use only the supplied cable to connect to the Serial Port. A standard serial interface cable is incompatible with the UPS.  
**Serial and USB Ports cannot be used simultaneously.**

The UPS features a transient voltage surge-suppression (TVSS) screw for connecting the ground lead on surge suppression devices such as telephone and network line protectors. Prior to connecting grounding cable, disconnect the UPS from utility power.

## Emergency Power Off

The Emergency Power Off (EPO) feature is user configurable. EPO provides immediate de-energizing of connected equipment from a remote location, without switching to battery operation.

1. Use the EPO connector supplied with the UPS.
2. Use a normally-open contact to connect the +24 terminal to the IN terminal, (see diagram).
3. Wire the four-pin connector to the EPO system.

EPO Port  
(located on rear panel)



EPO Connector

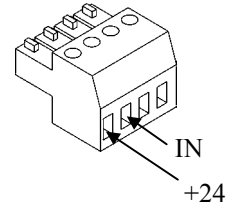

The EPO interface is a Safety Extra Low Voltage (SELV) circuit. Connect it only to other SELV circuits. The EPO interface monitors circuits that have no determined voltage potential. Such closure circuits may be provided by a switch or relay properly isolated from the utility. To avoid damage to the UPS, do not connect the EPO interface to any circuit other than a closure type circuit.

Use one of the following cable types to connect the UPS to the EPO switch:



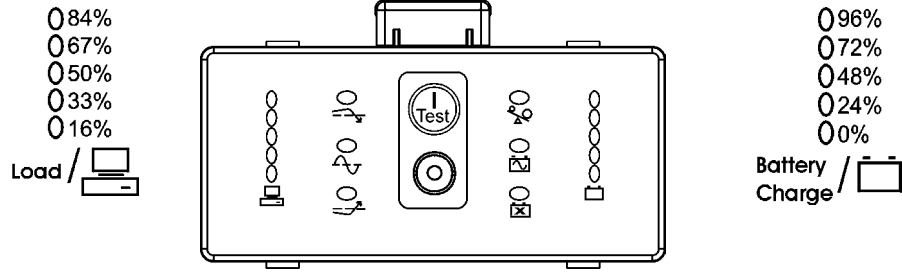

- CL2: Class 2 cable for general use
- CL2P: Plenum cable for use in ducts, plenums, and other spaces used for environmental air.
- CL2R: Riser cable for use in a vertical run in a floor to floor shaft.
- CLEX: Limited use cable for use in dwellings and for use in raceways.
- For installation in Canada: Use only CSA certified, type ELC (extra-low voltage control cable).

## 2: OPERATION

### Front Display Panel



INDICATOR	DESCRIPTION
Online 	The UPS is supplying utility power to the connected equipment (see <i>Troubleshooting</i> ).
AVR Trim 	The UPS is compensating for a high utility voltage.
AVR Boost 	The UPS is compensating for a low utility voltage.
On Battery 	The UPS is supplying battery power to the connected equipment.
Overload 	The connected loads are drawing more than the UPS power rating, (see <i>Troubleshooting</i> ).
Replace Battery/ Battery Disconnected 	The battery is disconnected or must be replaced, (see <i>Troubleshooting</i> ).
FEATURE	FUNCTION
Power On 	Press this button to turn on the UPS, (read on for additional capabilities).
Power Off 	Press this button to turn off the UPS.

FEATURE	FUNCTION
Self-Test	<p><b>Automatic:</b> The UPS performs a self-test automatically when turned on, and every two weeks thereafter, (by default). During the self-test, the UPS briefly operates the connected equipment on battery.</p> <p><b>Manual:</b> Press and hold the  button for a few seconds to initiate the self-test.</p>
Cold Start 208/120/230 V models Only	When there is no utility power and the UPS is off, the cold start feature will switch the UPS and connected equipment onto battery power, (see <i>Troubleshooting</i> ).
Diagnostic Utility Voltage  <b>120V</b> <b>208V</b> 0 133      0 246 0 123      0 228 0 115      0 208 0 105      0 190 0 98        0 171 <b>Battery Charge</b> <b>Battery Charge</b>  <b>100V</b> <b>230V</b> 0 81        0 266 0 91        0 248 0 100      0 229 0 109      0 210 0 119      0 191  	<p>The UPS has a diagnostic feature that displays the utility voltage.</p> <p><b>The UPS starts a self-test as part of this procedure. The self-test does not affect the voltage display.</b></p> <p>Press and hold the  button to view the utility voltage bar graph display. After a few seconds, this five-LED <i>battery charge</i>  display on the right of the front panel will show the utility input voltage.</p> <p>Refer to the figure at left for the voltage reading, (values are not listed on the UPS).</p> <p>The display indicates the voltage is between the displayed value on the list and the next higher value, (see <i>Troubleshooting</i>).</p>

## Battery Operation

The UPS switches to battery operation automatically if the utility power fails. While running on battery, an alarm beeps four times every 30 seconds.





Press the  button to silence this alarm. If the utility power does not return, the UPS continues to supply power to the connected equipment until the battery is fully discharged.

If PowerChute is not being used, files must be manually saved and the computer must be turned off before the UPS fully discharges the battery.





The UPS battery life differs based on usage and environment. Refer to [www.apc.com](http://www.apc.com) for on battery runtimes.



### 3: USER CONFIGURABLE ITEMS

NOTE: SETTINGS ARE ADJUSTED THROUGH POWERCHUTE SOFTWARE OR OPTIONAL SMART SLOT ACCESSORY CARDS.			
FUNCTION	FACTORY DEFAULT	USER SELECTABLE CHOICES	DESCRIPTION
Automatic Self-Test	Every 14 days (336 hours)	Every 7 days (168 hours), On Startup Only, No Self-Test	Set the interval at which the UPS will execute a self-test.
UPS ID	UPS_IDEN	Up to eight characters (alphanumeric)	Uniquely identify the UPS, (i.e. server name or location) for network management purposes.
Date of Last Battery Replacement	Manufacture Date	mm/dd/yy	Reset this date when you replace the battery module.
Minimum Capacity Before Return from Shutdown	0 percent	0, 15, 30, 45, 50, 60, 75, 90 percent	Following a low-battery shutdown, the battery modules will be charged to the specified percentage before powering connected equipment.
Voltage Sensitivity The UPS detects and reacts to line voltage distortions by transferring to battery operation to protect connected equipment.	 High	 : Brightly illuminated - <i>high</i> sensitivity.  : Dimly illuminated - <i>medium</i> sensitivity.  : No illumination; <i>low sensitivity</i> .	Adjust by pressing the <i>voltage sensitivity</i> button  (rear panel). Use a pointed object, (such as a pen) to do so.  Note: In situations of poor power quality, the UPS may frequently transfer to battery operation. If the connected equipment can operate normally under such conditions, reduce the sensitivity setting to conserve battery capacity and service life.
Alarm Delay Control	Enable	Enable, Mute, Disable	Mute ongoing alarms or disable all alarms permanently.
Shutdown Delay	90 seconds	0, 90, 180, 270, 360, 450, 540, 630 seconds	Set the interval between the time when the UPS receives a shutdown command and the actual shutdown.

**NOTE: SETTINGS ARE ADJUSTED THROUGH POWERCHUTE SOFTWARE  
OR OPTIONAL SMART SLOT ACCESSORY CARDS.**

FUNCTION	FACTORY DEFAULT	USER SELECTABLE CHOICES	DESCRIPTION
<p>Low Battery Warning</p>	<p> 2 minutes</p> <p>PowerChute software provides automatic, unattended shutdown when approximately 2 minutes of battery operated runtime remains.</p>	<p>: Brightly illuminated - low battery warning level of about 2 minutes.</p> <p>: Dimly illuminated - low battery warning level of about 5 minutes.</p> <p>: No illumination; low battery warning level is approximately 8 minutes.</p>	<p>The UPS will beep when 2 minutes of battery runtime remains.</p> <p>Change the warning interval setting by pressing the voltage sensitivity button, while pressing and holding the  button.</p> <p>Change the low battery warning interval setting to the time that the operating system or system software requires to safely shut down.</p>
<p>Synchronized Turn-on Delay</p>	<p>0 seconds</p>	<p>0, 60, 120, 180, 240, 300, 360, 420 seconds</p>	<p>Specify the time the UPS will wait after the return of utility power before turn-on, (to avoid branch circuit overload).</p>
<p>High Transfer Point</p>	<p><i>100 V model:</i> 108 Vac <i>120 V model:</i> 127 Vac <i>208 V model:</i> 225 Vac <i>230 V model:</i> 253 Vac</p>	<p><i>100 V model:</i> 108, 110, 112, 114 Vac <i>120 V model:</i> 127, 130, 133, 136 Vac <i>208 V model:</i> 225, 229, 233, 237 Vac <i>230 V model:</i> 253, 257, 261, 265 Vac</p>	<p>Set the high transfer point higher to avoid unnecessary battery usage when the utility voltage is usually high and the connected equipment is specified to operate with input voltages this high.</p>
<p>Low Transfer Point</p>	<p><i>100 V model:</i> 92 Vac <i>120 V model:</i> 106 Vac <i>208 V model:</i> 182 Vac <i>230 V model:</i> 208 Vac</p>	<p><i>100V model:</i> 92, 90, 88, 86 Vac <i>120 V model:</i> 97, 100, 103, 106 Vac <i>208 V model:</i> 170, 174, 178, 182 Vac <i>230 V model:</i> 196, 200, 204, 208 Vac</p>	<p>Set the low transfer point lower when the utility voltage is usually low and the connected equipment is specified to operate with input voltages this low.</p>
<p>Output Voltage <i>230 V Model Only</i></p>	<p>230 Vac</p>	<p>220, 230, 240 Vac</p>	<p>Select the output voltage.</p>

## 4: STORAGE, MAINTENANCE, TRANSPORTING, AND SERVICE

### Storage

Store the UPS covered in a cool, dry location, with the batteries fully charged.

At -15 to +30 °C (+5 to +86 °F), charge the UPS battery every six months.

At +30 to +45 °C (+86 to +113 °F), charge the UPS battery every three months.

### Replacing the Battery Module

The UPS battery life differs based on usage and environment.

This UPS has an easy to replace, hot-swappable battery module. Replacement is a safe procedure, isolated from electrical hazards. You may leave the UPS and connected equipment on during the replacement procedure. See your dealer or contact APC at [www.apc.com](http://www.apc.com) for information on replacement battery modules.

Refer to *Mount the UPS in a Rack* for instructions on battery removal and replacement.



**Be sure to deliver the spent battery to a recycling facility or ship it to APC in the replacement battery packing material.**

Once the battery(s) are disconnected, the connected equipment is not protected from power outages.

**Be careful during battery replacement-the battery modules are heavy.**

### Transporting

1. Shut down and disconnect any equipment attached to the UPS.
2. Shut down the UPS, and disconnect the UPS from the utility power outlet.
3. Remove the front bezel, and unplug the battery connector.

**For shipping instructions and to obtain appropriate packing materials, refer to [www.apc.com/support/contact](http://www.apc.com/support/contact).**

## **Service**

If the UPS requires service do not return it to the dealer. Follow these steps:

1. Review the problems discussed in *Troubleshooting* to eliminate common problems.
2. If the problem persists, contact APC Customer Service through the APC web site, [www.apc.com/support](http://www.apc.com/support).
  - Note the model number of the UPS, the serial number, and the date purchased. If you call APC Customer Service, a technician will ask you to describe the problem and attempt to solve it over the phone. If this is not possible, the technician will issue a Returned Material Authorization Number (RMA#).
  - If the UPS is under warranty, repairs are free.
  - Procedures for servicing or returning products may vary internationally. Refer to the APC web site for country specific instructions.
3. Pack the UPS in its original packaging. If this is not available, refer to [www.apc.com/support](http://www.apc.com/support) for information about obtaining a new set.
  - Pack the UPS properly to avoid damage in transit. Never use Styrofoam beads for packaging. Damage sustained in transit is not covered under warranty.
  - **Always DISCONNECT THE BATTERY before shipping in compliance with U.S. Department of Transportation (DOT) regulations.** The battery may remain in the UPS; it does not have to be removed.
4. Mark the RMA# on the outside of the package.
5. Return the UPS by insured, prepaid carrier to the address given to you by Customer Service.



## **Contact Information**



U.S. Customers - Refer to [www.apc.com/support](http://www.apc.com/support).

International Customers - Refer to [www.apc.com](http://www.apc.com), select the appropriate country from the country selection field, and select the *Support* tab at the top of the web page.

## 5: TROUBLESHOOTING

Use the chart below to solve minor UPS installation and operation problems. Refer to [www.apc.com](http://www.apc.com) with complex UPS problems.

PROBLEM AND/OR POSSIBLE CAUSE	SOLUTION
<b>UPS WILL NOT TURN ON</b>	
Battery not connected properly.	Check that the battery connector is fully snapped into position.
 button not pushed.	Press the  button once to power the UPS and the connected equipment.
UPS not connected to utility power supply.	Check that the power cord is securely connected at both ends.
Very low or no utility voltage present.	Check the utility power supply to the UPS by plugging in a table lamp. If the light is very dim, have the utility voltage checked.
<b>UPS WILL NOT TURN OFF</b>	
The UPS is experiencing an internal fault.	Do not attempt to use the UPS. Unplug the UPS and have it serviced immediately.
<b>UPS BEEPS OCCASIONALLY</b>	
Normal operating UPS beeps when running on battery.	None. The UPS is protecting the connected equipment from occasional utility power irregularities.
<b>UPS IS NOT PROVIDING EXPECTED BACKUP TIME</b>	
The UPS battery is weak due to a recent outage or is near the end of the service life.	Charge the battery. Batteries require recharging after extended outages. They can wear faster when put into service often or when operated at elevated temperatures. If the battery is near the end of the service life, consider replacing the battery even if the <i>replace battery</i> LED is not yet illuminated.
<b>ALL LEDs ARE ILLUMINATED AND THE UPS EMITS A CONSTANT BEEPING</b>	
The UPS is experiencing an internal fault.	Do not attempt to use the UPS. Turn off the UPS and have it serviced immediately.
<b>FRONT PANEL LEDs FLASH SEQUENTIALLY</b>	
The UPS has been shut down remotely through software or an optional accessory card.	None. The UPS will restart automatically when utility power returns.
<b>ALL LEDs ARE OFF AND THE UPS IS PLUGGED INTO A WALL OUTLET</b>	
The UPS is shut down or the battery is discharged from an extended outage.	None. The UPS will return to normal operation when the power is restored and the battery has a sufficient charge.

PROBLEM AND/OR POSSIBLE CAUSE	SOLUTION
<b>THE OVERLOAD LED IS ILLUMINATED AND THE UPS EMITS A SUSTAINED ALARM TONE</b>	
The UPS is overloaded. The connected equipment exceeds the “maximum load,” as defined in <i>Specifications</i> at <a href="http://www.apc.com">www.apc.com</a> .	<p>The alarm remains on until the overload is removed. Disconnect nonessential equipment from the UPS.</p> <p>The UPS continues to supply power as long as it is online and the circuit breaker does not trip; the UPS will not provide power from batteries in the event of a utility voltage interruption.</p> <p>If a continuous overload occurs while the UPS is on battery, the unit turns off output in order to protect the UPS from possible damage.</p>
<b>THE REPLACE BATTERY/BATTERY DISCONNECTED LED IS ILLUMINATED</b>	
This LED flashes and short beep is emitted every two seconds to indicate the battery is disconnected.	Check that the battery connectors are fully engaged.
Weak battery.	Allow the battery to recharge for 24 hours and perform a self-test. If the problem persists after recharging, replace the battery.
Failure of a battery self-test. This LED is illuminated and the UPS emits short beeps for one minute. The UPS repeats the alarm every five hours.	<p>Allow the battery to recharge for 24 hours and perform another self-test to confirm the <i>replace battery</i> condition. If the battery passes the self-test, the alarm will stop and the LED will clear.</p> <p>If the battery fails again, it must be replaced. The connected equipment is unaffected.</p>
<b>THE SITE WIRING FAULT LED ON THE REAR PANEL IS ILLUMINATED (120 V MODEL ONLY)</b>	
The UPS is plugged into an improperly wired utility power outlet.	<p>Wiring faults detected include missing ground, hot-neutral polarity reversal, and overloaded neutral circuit.</p> <p>Contact a qualified electrician to correct the building wiring.</p>
<b>THE INPUT CIRCUIT BREAKER TRIPS</b>	
The UPS is overloaded.	Reduce the load on the UPS by unplugging equipment. Reset the breaker.
<b>THE AVR BOOST OR AVR TRIM LEDS ARE ILLUMINATED</b>	
Your system is experiencing a period of low or high voltage.	Have qualified service personnel check your facility for electrical problems. If the problem continues, contact the utility company for further assistance.
<b>THERE IS NO UTILITY POWER</b>	
There is no utility power and the UPS is off.	<p><i>120/208/230 V models only:</i> Use the Cold Start feature to supply power to the connected equipment from the UPS battery.</p> <p>Press the  button for one second and release. The UPS will beep briefly.</p> <p>Press and hold the  button again for about three seconds. The unit will emit two beeps. Release the button during the second beep.</p>

<b>PROBLEM AND/OR POSSIBLE CAUSE</b>	<b>SOLUTION</b>
<b>UPS OPERATES ON BATTERY ALTHOUGH LINE VOLTAGE EXISTS</b>	
The UPS input circuit breaker tripped.	Reduce the load on the UPS by unplugging equipment. Reset the breaker.
Very high, low, or distorted line voltage.	Move the UPS to a different outlet on a different circuit; inexpensive fuel powered generators may distort the voltage. Test the input voltage with the utility voltage display, (see <i>Operation</i> ). If acceptable to the connected equipment, reduce the UPS sensitivity.
<b>BATTERY CHARGE AND LOAD LEDS FLASH SIMULTANEOUSLY</b>	
The UPS has shutdown.  The internal temperature of the UPS has exceeded the allowable threshold for safe operation.	Check that the room temperature is within the specified limits for operation.  Check that the UPS is properly installed, allowing for adequate ventilation.  Allow the UPS to cool down. Restart the UPS. If the problem continues, contact APC at <a href="http://www.apc.com/support">www.apc.com/support</a> .
<b>DIAGNOSTIC UTILITY VOLTAGE</b>	
All five LEDs are illuminated.	The line voltage is extremely high and should be checked by an electrician.
There is no LED illumination.	If the UPS is plugged into a properly functioning utility power outlet, the line voltage is extremely low.
<b>ONLINE LED</b>	
There is no illumination.	The UPS is running on battery, or it must be turned on.
The LED is blinking.	The UPS is running an internal self-test.

## 6: REGULATORY AND WARRANTY INFORMATION

### Regulatory Agency Approvals and Radio Frequency Warnings

#### 120/208 V models



BSMI

警告使用者：  
這是甲類的資訊產品，在居住的環境中使用時，可能會造成射頻干擾，在這種情況下，使用者會被要求採取某些適當的對策。

#### 230 V models



This equipment has been tested and found to comply with the limits for a Class A digital device, pursuant to part 15 of the FCC Rules. These limits are designed to provide reasonable protection against harmful interference when the equipment is operated in a commercial environment. This equipment generates, uses, and can radiate radio frequency energy and, if not installed and used in accordance with the instruction manual, may cause harmful interference to radio communications. Operation of this equipment in a residential area is likely to cause harmful interference in which case the user will be required to correct the interference at his/her own expense.

This is a Class A product. In a domestic environment this product may cause radio interference, in which case the user may be required to take corrective actions.

Shielded signal cables must be used with this product to ensure compliance with the Class A FCC limits.

#### 100 V MODELS



この装置は、情報処理装置等電波障害自主規制協議会（VCCI）の基準に基づくクラスA情報技術装置です。この装置を家庭環境で使用すると電波妨害を引き起こすことがあります。この場合には使用者が適切な対策を講ずるよう要求されることがあります。



# Declaration of Conformity

2003 EC Declaration of Conformity	
We, the undersigned, declare under our sole responsibility that the equipment specified below conforms to the following standards and directives:	
Standards to Which Conformity Declared:	EN6240-1-1, EN55022, EN55024, EN61060-3-2, 3-1, 4-2, 4-3, 4-4, 4-5, 4-6, 4-8, 4-11, EN60950-1, IEC60950-1
Application of Council Directives:	73/23/EEC, 93/68/EEC
Type of Equipment:	Power Supply
Model Numbers:	SUA3300RMEU, SUA2300RMEU
Manufacturer's Name and Address:	American Power Conversion 132 Fingernade Road West Kingston, Rhode Island, 02892, USA -or- American Power Conversion (A. P. C.) b. v. Ballyfern Business Park Galway, Ireland -or- American Power Conversion 2nd Street PEZA Cebu Economic Zone Remosa, Cebu Philippines -or- American Power Conversion Lot 10, Block 16, Phase 4 PEZA, Alabaca, Cebu Philippines -or- American Power Conversion Lot 3, Block 14, Phase 3 PEZA, Alabaca, Cebu Philippines -or- APC (Shenzhen) UPS Co., Ltd 335 Sulong Zhang Lu Shenzhen Industrial Park Shenzhen Jintang 519021 P.R. China
Importer's Name and Address:	American Power Conversion (A. P. C.) b. v. Ballyfern Business Park Galway, Ireland
Place:	N. Billerica, MA U.S.A. Richard J. Everett, Sr. Regulatory Compliance Engineer 5 Jun 03
Place:	Galway, Ireland Ray S. Ballard, Managing Director, Europe 5 Jun 03

## Limited Warranty

American Power Conversion (APC) warrants its products to be free from defects in materials and workmanship for a period of two years from the date of purchase. Its obligation under this warranty is limited to repairing or replacing, at its own sole option, any such defective products. To obtain service under warranty you must obtain a Returned Material Authorization (RMA) number from customer support. Products must be returned with transportation charges prepaid and must be accompanied by a brief description of the problem encountered and proof of date and place of purchase. This warranty does not apply to equipment that has been damaged by accident, negligence, or misapplication or has been altered or modified in any way. This warranty applies only to the original purchaser who must have properly registered the product within 10 days of purchase.

EXCEPT AS PROVIDED HEREIN, AMERICAN POWER CONVERSION MAKES NO WARRANTIES, EXPRESSED OR IMPLIED, INCLUDING WARRANTIES OF MERCHANTABILITY AND FITNESS FOR A PARTICULAR PURPOSE. Some states do not permit limitation or exclusion of implied warranties; therefore, the aforesaid limitation(s) or exclusion(s) may not apply to the purchaser.

EXCEPT AS PROVIDED ABOVE, IN NO EVENT WILL APC BE LIABLE FOR DIRECT, INDIRECT, SPECIAL, INCIDENTAL, OR CONSEQUENTIAL DAMAGES ARISING OUT OF THE USE OF THIS PRODUCT, EVEN IF ADVISED OF THE POSSIBILITY OF SUCH DAMAGE. Specifically, APC is not liable for any costs, such as lost profits or revenue, loss of equipment, loss of use of equipment, loss of software, loss of data, costs of substitutes, claims by third parties, or otherwise.

Entire contents copyright © 2003 by American Power Conversion Corporation. All rights reserved. Reproduction in whole or in part without permission is prohibited.

APC, Smart-UPS, and PowerChute are registered trademarks of American Power Conversion Corporation. All other trademarks are the property of their respective owners.