



S8-PR/MR...W13

Contrast sensor

INSTRUCTION MANUAL

CONTROLS

OUTPUT LED (yellow)

The yellow LED ON indicates the output status.

READY LED (green)

The green LED ON indicates the powering status.

SET PUSH-BUTTON

A long pressure on the push-button activates the teach procedure. The REMOTE input allows the external control of the SET push-button.

DARK/LIGHT TRIMMER (only for dynamic setting)

The light/dark mode is selected by a monoturn trimmer.

Please refer to the "SETTING" paragraph to get the correct setting procedure.

WARNING: the maximum mechanical rotation range of the trimmer is 240°.

Do not force over of the maximum and minimum positions.

INSTALLATION

S8-PR:

The sensor can be positioned by means of the two housing holes using two screws (M3x18 or longer, 0.8Nm maximum tightening torque) with washers.

S8-MR:

The sensor can be positioned by means of the two threaded holes using two screws (M3x14 or longer, 0.8Nm maximum tightening torque) with washers.

Various orientable fixing brackets to ease the sensor positioning are available (please refer to the accessories listed in the general catalogue).

The operating distance is measured from the front surface of the sensor optics.

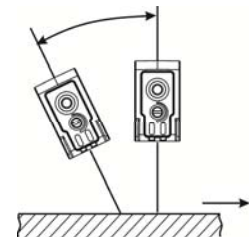
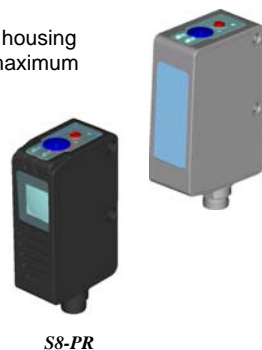

Mark detection on a reflective surface is improved adjusting the beam direction to 5° ... 20° from surface axis.

CONNECTIONS

M8 connector

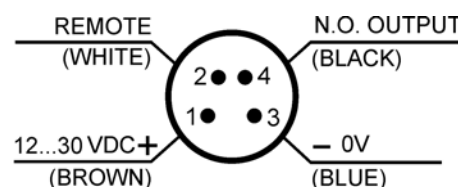

Pig-tail with M12 connector

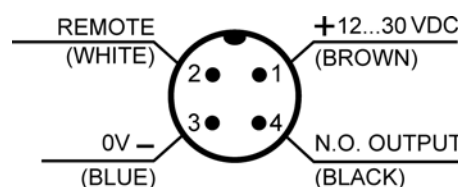

TECHNICAL DATA

Power supply:	12 ... 30 VDC Class 2 (Type 1 for S8-MR) UL508
Ripple:	2 Vpp max.
Current consumption (output current excluded):	30 mA max
Outputs:	PNP or NPN N.O.; 30 VDC max. (short-circuit protection) Pull-down/up resistance = 47 KΩ
Output current:	100 mA (overload protection)
Output saturation voltage:	≤ 2 V
Response time:	20 μs
Switching frequency:	25 kHz
Emission type:	BLUE (465 nm) / GREEN (520 nm) / RED (630 nm) with automatic selection
Spot dimension:	3x1 mm ²
Operating distance (typical values):	9 mm
Depth of field:	± 3 mm
LIGHT/DARK selection:	Mono-turn trimmer (only for dynamic setting)
Indicators:	OUTPUT LED (YELLOW) / READY LED (GREEN)
Operating temperature:	-10 ... 55 °C
Storage temperature:	-20 ... 70 °C
Dielectric strength:	☐: 1500 VAC 1 min. between electronics and housing
Insulating resistance:	>20 MΩ 500 Vdc between electronics and housing
Ambient light rejection:	according to EN 60947-5-2
Vibrations:	0.5 mm amplitude, 10 ... 55 Hz frequency, for each axis (EN60068-2-6)
AtEx environment:	☉ II 3G E Ex nA II T6 / II 3D E Ex tD A22 IP67 T85°C
Shock resistance:	11 ms (30 G) 6 shocks for each axis (EN60068-2-27)
Housing material:	ABS (S8-PR) / INOX AISI 316L (S8-MR)
Lens material:	Window in glass; lens in PC (S8-PR) / window in PMMA (S8-MR)
Mechanical protection:	IP67 (S8-PR) / IP67, IP69K (S8-MR)
Connections:	M8 4-pole connector / 150 mm Ø 4 mm cable with M12 4-pole connector (S8-PR pig-tail vers.)
Weight:	12 g. max. (S8-PR connector vers.) / 50 g. max. pig-tail (S8-PR pig-tail vers.) 70 g. max (S8-MR connector vers.)

SETTINGS

MARK-BACKGROUND ACQUISITION

Mark acquisition

The DARK/LIGHT mode is automatically selected by the sensor. Place mark in front of the sensor spot and press SET push-button until the green READY LED turns off (1 sec).

The sensor functions alternating red, green and blue emissions. Do not move the mark during this phase.

Background acquisition

Place background in front of the sensor spot and press SET push-button again. The sensor functions alternating red, green and blue emissions. Do not move the mark during this phase.

DYNAMIC ACQUISITION

Use the dynamic setting to detect moving target. The sensor sets automatically the threshold value during target movement. The DARK/LIGHT mode has to be previously set.

LIGHT/DARK MODE SETTING

LIGHT mode setting

Rotate trimmer in an anti-clockwise direction to set the LIGHT mode (clear mark on dark background).

DARK mode setting

Rotate trimmer in a clockwise direction to set the DARK mode mode (dark mark on clear background).

Dynamic detection

Position the sensor spot in front of the target to detect.

Press SET push-button until the green READY LED turns off (3sec) and keep it pressed.

To end the dynamic detection procedure release the SET push-button.

The sensor functions alternating red, green and blue emissions.

SETTING RESULT

The switching threshold is typically placed 25% below the mark. If the sensing conditions are accepted, at the end of teach procedure the READY LED blinks x2 for 3sec.

If SET push-button is pressed in this 3 seconds the switching threshold is placed in the midpoint between the mark and the background.

If the READY LED blinks fast the acquisition failed for to insufficient contrast. Press SET push-button and the sensor returns to the previous setting

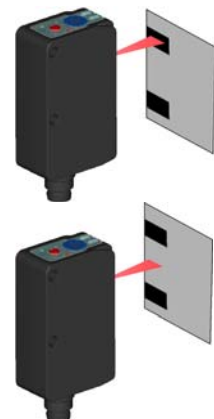

OTHER FUNCTIONS

KEYLOCK function (keyboard lock)

The KEYLOCK function (keyboard lock) allows to deactivate the SET push-button avoiding accidental changes in the sensor setting. If at sensor powering the REMOTE wire is connected to +Vdc for at least 1 sec., the keylock function is activated and the push-button is no longer active.

To deactivate the keylock, the sensor must be turned off and repowered with the REMOTE wire not connected or connected to GND.

REMOTE input

Different detection functions can be made with the REMOTE signal, without using the SET push-button.

The REMOTE wire connected to +VDC is equal to pressing the SET push-button, it connected to GND or not connected is equal to not pressing the SET push-button.

The connection duration of the REMOTE wire to +VDC determines the detected type requested:

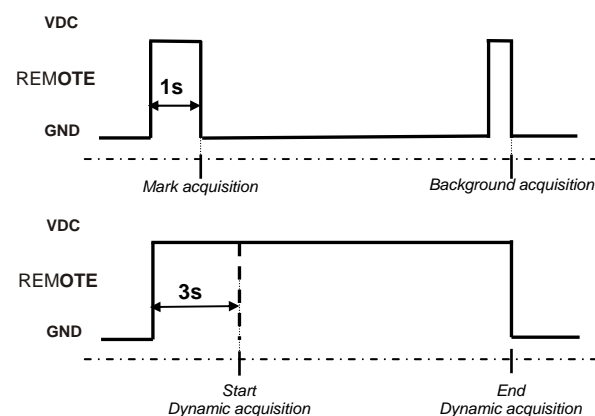

DIMENSIONS

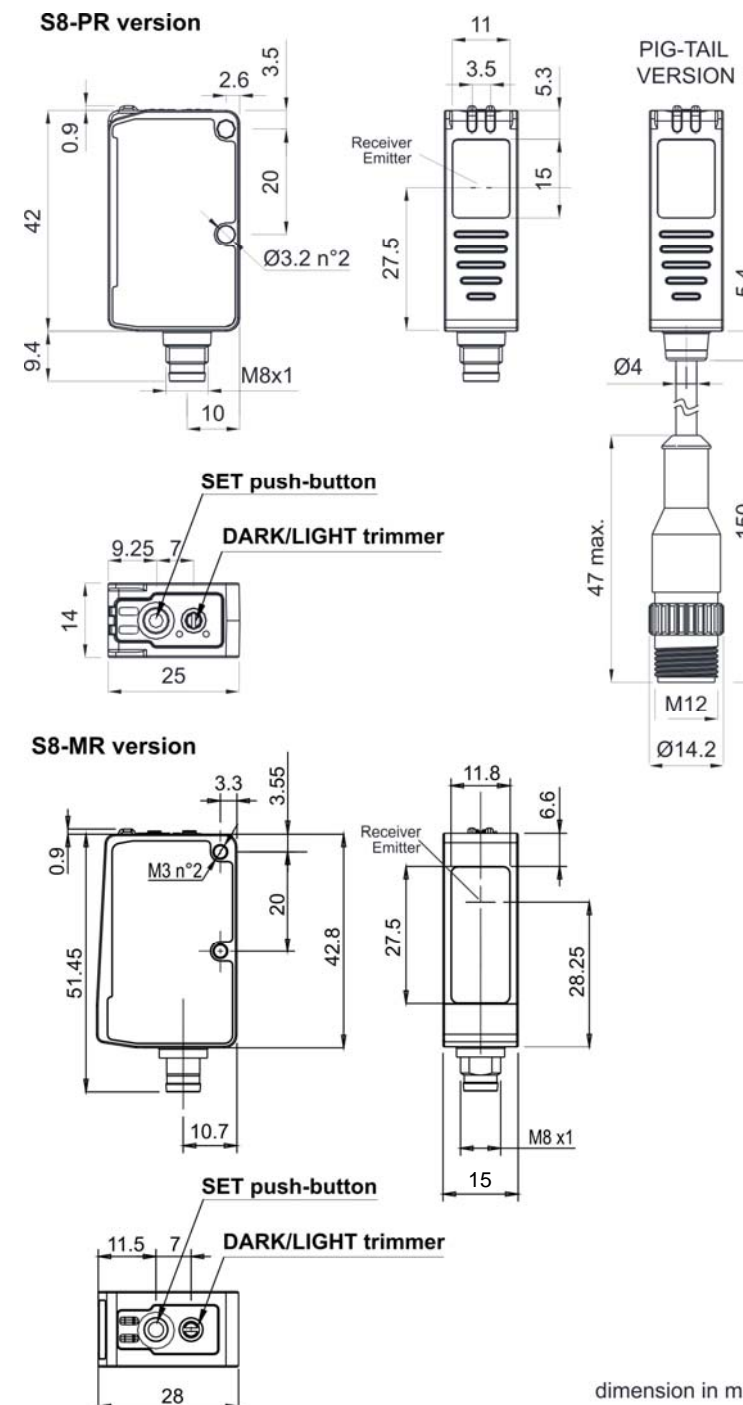

dimension in mm

The sensors are NOT safety devices, and so MUST NOT be used in the safety control of the machines where installed.

WARRANTY

Datalogic Automation warrants its products to be free from defects. Datalogic Automation will repair or replace, free of charge, any product found to be defective during the warranty period of 36 months from the manufacturing date. This warranty does not cover damage or liability deriving from the improper application of Datalogic Automation products.

DATALOGIC AUTOMATION srl

Via Lavino 265 - 40050 Monte S. Pietro - Bologna - Italy
Tel: +39 051 6765611 - Fax: +39 051 6759324 www.datalogic.com

Under current Italian and European laws, Datalogic Automation is not obliged to take care of product disposal at the end of its life. Datalogic Automation Recommends to dispose of the product in compliance with local laws or contact authorised waste collection centres. Datalogic Automation reserves the right to make modifications and improvements without prior notification.

© 2013 - 2016 Datalogic Automation - ALL RIGHTS RESERVED - Protected to the fullest extent under U.S. and international laws. • Copying, or altering of this document is prohibited without express written consent from Datalogic Automation. Datalogic and the Datalogic logo are registered trademarks of Datalogic S.p.A. in many countries, including the U.S.A. and the E.U.