

## AS1 trimmer INSTRUCTION MANUAL

### CONTROLS

**OUT LED on receiver (RX)**  
The yellow LED ON indicates the presence of the object into controlled area.

**POWER ON LED on receiver (RX)**  
The green LED ON indicates the optimal device functioning. The fast blinking of the green LED indicates a critical device alignment. Please refer to "DIAGNOSTICS" paragraph for other indications.

**POWER ON LED on emitter (TX)**  
The green LED ON indicates the correct device functioning. Please refer to "DIAGNOSTICS" paragraph for other indications.

### INSTALLATION MODE

#### General information on device positioning

- Align the two receiver (RX) and emitter (TX) units, verifying that their distance is inside the device operating distance, in a parallel manner placing the sensitive sides one in front of the other, with the connectors oriented on the same side. The critical alignment of the unit will be signalled by the fast blinking of the green receiver LED.

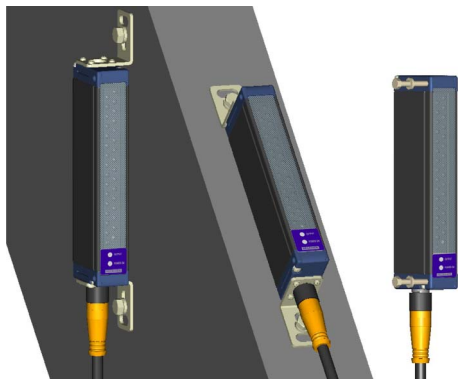

- Mount the two receiver and emitter units on rigid supports which are not subject to strong vibrations, using specific fixing brackets and /or the holes present on the device lids.

#### Precautions to respect when choosing and installing the device

- Choose the device according to the minimum object to detect and the maximum controlled area requested.
- In agro-industrial applications, the compatibility of light grid housing material and any chemical agents used in the production process has to be verified with the assistance of the DATALOGIC technical sales support department.
- The **AREAscan™** light grids are NOT safety devices, and so MUST NOT be used in the safety control of the machines where installed.

Moreover the following points have to be considered:

- Avoid installation near very intense and / or blinking light sources, in particular near to the receiver unit.
- The presence of strong electromagnetic disturbances can jeopardise the correct functioning of the device. This condition has to be carefully evaluated and checked with the DATALOGIC technical sales support department;
- The presence of smoke, fog and suspended dust in the working environment can reduce the device's operating distance.
- Strong and frequent temperature variations, with very low peak temperatures, can generate a thin condensation layer on the optics surfaces, compromising the correct functioning of the device. Reflecting surfaces near the luminous beam of the **AREAscan™** device (above, under or lateral) can cause passive reflections able to compromise object detection inside the controlled area. For a right functioning of the device, it is recommended to align it correctly and to maintain the minimum distance  $D_r$  from any reflecting surface (see the formula in "Technical Data").
- if different devices have to be installed in adjacent areas, the emitter of one unit must not interfere with the receiver of the other unit.

#### General information relative to object detection and measurement

- For a correct object detection and / or measurement, the object has to pass completely through the controlled area. Testing the correct detection before beginning the process is suggested. The resolution is non uniform inside the entire controlled area. For example the resolution in the AS1-HR model depends on the scanning program chosen.

### CONNECTIONS

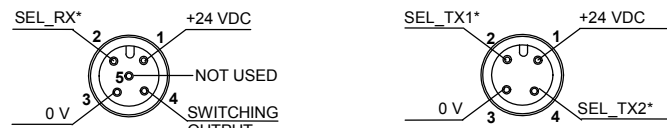

RECEIVER (RX): M12 5-pole connector	AS1-HR	AS1-SR	EMITTER (TX): M12 4-pole connector	AS1-HR	AS1-SR
1 - brown:	+24 VDC	+24 VDC	1 - brown:	+24 VDC	+24 VDC
2 - white:	SEL_RX*	Not used	2 - white:	SEL_TX1*	Not used
3 - blue:	0 V	0 V	3 - blue:	0 V	0 V
4 - black:	Switching output	Switching output	4 - black:	SEL_TX2*	Not used
5 - grey:	Not used	Not used			

(\*) see the paragraph "SCANNING PROGRAMS"

- Shielded cables are not foreseen in the standard connection
- Ground connection of the two units is not necessary

### FUNCTIONING AND PERFORMANCES

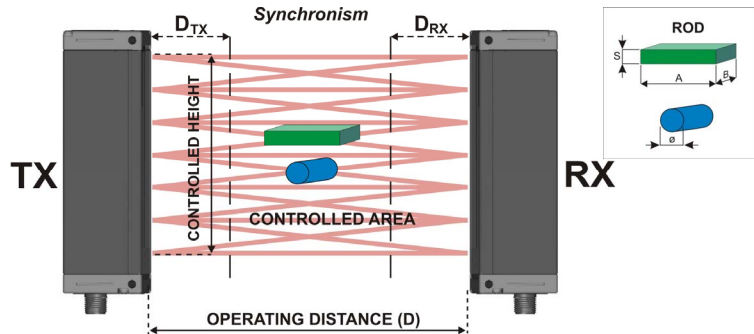

The beam interruption due to the passage of an object inside the controlled area causes the closing of the switching output. The device can detect envelopes, sheets, cards, tapes, foils with a reduced thickness (reaching dimensions of only 0.2 mm) and spherical objects with a minimum diameter of 6 mm, depending on the scanning program chosen and the position of the object within the controlled area. In particular, the switching output is always activated when at least one beam is obscured. The status variation is signalled by the yellow receiver LED that turns on.

The device presents inputs (both on TX and RX units) that consent the selection of the resolution and response time. Low response times correspond to worse resolutions and viceversa.

The device does not require calibration; periodical checks of the resolution and/or measurement are however suggested. The blinking of the yellow receiver LED signals the critical alignment of the units and / or the functioning outside or near the maximum operating distance. In optimal conditions the LED remains off continuously (stability condition).

The two units are synchronised via optic signal. As shown in the picture above, the optic involved in the synchronization process is the one closest to the top end cap. To ensure a correct use of the device it is necessary that the portion of controlled area associated with this optic is not obscured.

### EMISSION POWER REGULATION

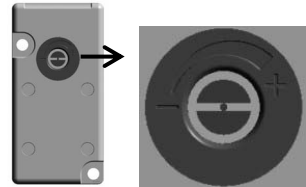

The emitter is equipped with a trimmer which let user change the emission power. The operating distance increases rotating the trimmer clockwise. The emission power reduction it is useful to decrease passive reflections when the maximum operating distance it is not required. Trimmer rotation is limited to 260°. Do not apply a torque greater than 35 Nmm.

Rotate the trimmer clockwise to the limit (maximum emission), then align RX and TX at the required operating distance (LED OUT off); decrease emission power rotating the trimmer counterclockwise until the output switches (LED OUT off) or the limit is reached (minimum emission); in the first case, rotate the trimmer clockwise until the output switches again and LED OUT remains off.

### DIAGNOSTICS

#### RECEIVER UNIT:

Signal	Status	Cause	Action
OUTPUT (Yellow LED)	ON	Switching output. Presence of the object in the controlled area.	
POWER ON (Green LED)	OFF	Switching output. Controlled area free of objects.	
OUT LED (Yellow LED)	ON	Optimal functioning.	
POWER ON (Green LED)	Fast blinking	Critical alignment of the unit or/and functioning closed to maximum operating distance.	
POWER ON (Green LED)	Slow blinking	Wrong connections and/or malfunctioning.	<ul style="list-style-type: none"> <li>Verify the output connections and any short-circuits.</li> <li>Switch OFF and switch ON the device.</li> <li>If condition persists, contact Datalogic.</li> </ul>
POWER ON (Green LED)	OFF	Device is not powered.	<ul style="list-style-type: none"> <li>Verify the connections.</li> <li>If condition persists, contact Datalogic.</li> </ul>

#### EMITTER UNIT:

Signal	Status	Cause	Action
POWER ON (Green LED)	ON	Normal functioning of emission unit.	
EMITTER (Green LED)	Blinking	Unit malfunctioning.	<ul style="list-style-type: none"> <li>Switch OFF and switch ON the device.</li> <li>If condition persists, contact Datalogic.</li> </ul>
POWER ON (Green LED)	OFF	Device is not powered.	<ul style="list-style-type: none"> <li>Verify the connections and right value of power supply.</li> <li>If condition persists, contact Datalogic.</li> </ul>

### TECHNICAL DATA

	AS1-LD-HR-010-P	AS1-LD-SR-010-P
Power supply:	24 Vdc ± 15%	
Consumption on emitter unit (TX):	150 mA max.	
Consumption on receiver unit (RX):	40 mA max, load excluded	
Switching output:	1 PNP output	
Switching output current:	100 mA; short-circuit protection	
Output saturation voltage:	≤ 1.5 V at T=25 °C	
Resolution:	see table "Resolution in the zone of max. sensitivity"	
Distance to refl. surface (D <sub>r</sub> ):	D <sub>r</sub> (m) = 0.08+0.22 x (D-0.2)	
Response time:	2.75 - 8 ms	1.75 ms
Operating temperature:	0...+ 50 °C	
Storage temperature:	-25...+ 70 °C	
Operating distance (typical values):	0.3 - 2.1 m	
Emission type:	Infrared (880 nm)	
Indicators:	RX: OUT LED (yellow) / POWER ON LED (green) TX: POWER ON LED (green)	
Controlled height:	100 mm	
N° beams:	16	6
Vibrations:	0.5 mm amplitude, 10 ... 55 Hz frequency, for every axis (EN60068-2-6)	
Shock resistance:	11 ms (30 G) 6 shock for every axis (EN60068-2-27)	
Housing material:	Black electro-painted aluminium	
Lens material:	PMMA	
Mechanical protection:	IP65 (EN 60529)	
Connections:	M12 4-pole connector for TX M12 5-pole connector for RX	
Weight:	300 g.	

(\*\*): H: dimension along controlled area vertical axis (controlled height)  
L: dimension along the axis orthogonal to controlled height axis

### SCANNING PROGRAMS (only AS1-LD- HR-010-P)

The AS1-HR model presents inputs for the selection of the scanning program (SEL\_RX ; SEL\_TXX).

The selection is made connecting the inputs to 0V or to +24Vdc.

The scanning program is activated only after input selection and device re-powering.

A different scanning program cannot be activated during device functioning.

According to the combination of the inputs selected, the response time or resolution can be preferred, as described in the following table. The standard configuration (SEL\_RX and SEL\_TXX floating inputs) corresponds to the lower resolution and highest response time.

PROG. N°	SEL_RX	SEL_TX1	SEL_TX2	RES.	RESPONSE TIME (msec)
1	0V or FLOAT	0V or FLOAT	+24Vcc or FLOAT	LOW	2.75
2	0V or FLOAT	0V or FLOAT	0V	MEDIUM LOW	3
3	+24Vcc	+24Vcc	+24Vcc or FLOAT	MEDIUM HIGH	7.75
4	+24Vcc	+24Vcc	0V	HIGH	8

Resolution figure: the box indicated the area with highest resolution

PROGRAM 1	PROGRAM 2	PROGRAM 3 - 4
Ideal for fast detection on entire controlled area, with low resolution.	Ideal for fast detection on entire controlled area, with constant resolution on limited area.	Ideal for detection with high resolution on entire controlled area.

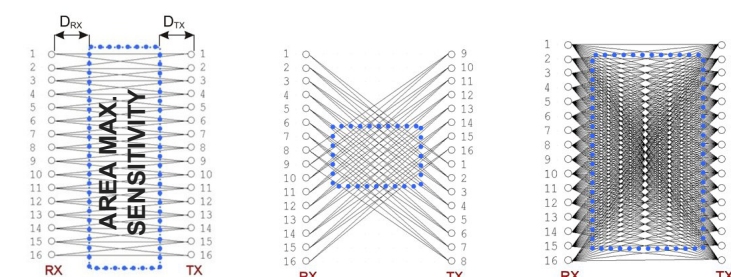

### RESOLUTION IN THE ZONE OF MAX. SENSITIVITY

MODEL	FLAT ROD ( SxAxB mm)	trimmer to min			
		DTx (cm)	DRx (cm)	D <sub>min</sub> (cm)	D <sub>MAX</sub> (cm)
AS1-LD-HR-010-P	Scan mode prog 1 → 0,4x100x65	20	40	75	150
	Scan mode prog 2 → 0,4x90x65	= 0,7D-11,4	= 0,7D-11,4	30	65
	Scan mode prog 3/4 → 0,2x75x65	20	40	65	150
AS1-LD-SR-010-P	0,2x200x65	= 0,4D-7,9	= 0,4D-7,9	30	65
		20	25	65	180

MODEL	FLAT ROD ( SxAxB mm)	trimmer to MAX			
		DTx (cm)	DRx (cm)	D <sub>min</sub> (cm)	D <sub>MAX</sub> (cm)
AS1-LD-HR-010-P	Scan mode prog 1 → 0,4x100x65	20	40	75	210
	Scan mode prog 2 → 0,4x90x65	20	40	65	210
	Scan mode prog 3/4 → 0,2x75x65	= 0,4D-0,7	= 0,4D-0,7	30	55
AS1-LD-SR-010-P	0,2x200x65	15	25	55	210
		= 0,4D-7,9	= 0,4D-7,9	30	100
		25	35	100	210

MODEL	CYLINDRICAL ROD ( Ø mm )	trimmer to min			
		DTx (cm)	DRx (cm)	D <sub>min</sub> (cm)	D <sub>MAX</sub> (cm)
AS1-LD-HR-010-P	Scan mode prog 1 → 6	30	20	55	150
	Scan mode prog 2 → 6	= 0,4D+8	= 0,4D-8	30	55
	Scan mode prog 3/4 → 6	30	20	55	150
AS1-LD-SR-010-P	18	10	10	30	180

MODEL	CYLINDRICAL ROD ( Ø mm )	trimmer to MAX			
		DTx (cm)	DRx (cm)	D <sub>min</sub> (cm)	D <sub>MAX</sub> (cm)
AS1-LD-HR-010-P	Scan mode prog 1 → 6	40	30	75	210
	Scan mode prog 2 → 6	= 0,3D+8,3	= 0,3D+8,3	30	65
	Scan mode prog 3/4 → 6	30	30	65	210
AS1-LD-SR-010-P	18	20	15	40	210
		15	10	30	210

### DIMENSIONS

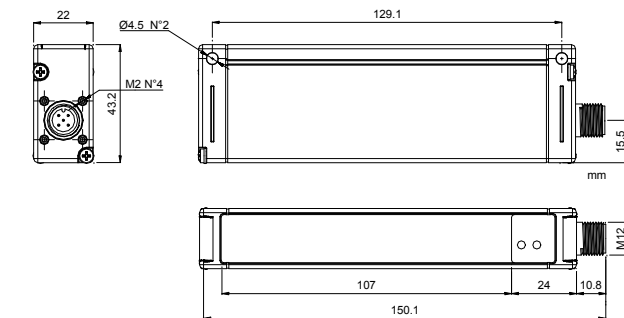

### FIXING BRACKET

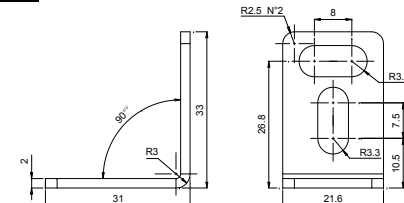

### PRODUCT WITH FIXING BRACKET

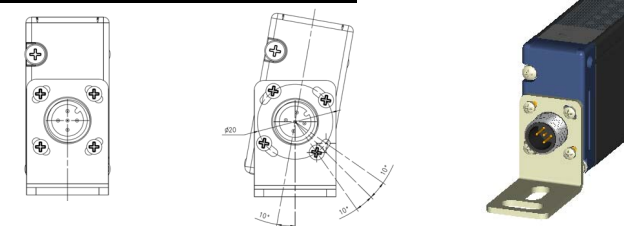

Datalogic S.r.l.  
Via S. Vitalino 13 - 40012 Calderara di Reno - Italy  
Tel: +39 051 3147011 - Fax: +39 051 3147205 - www.datalogic.com

Helpful links at www.datalogic.com: [Contact Us](#), [Terms and Conditions](#), [Support](#).

The warranty period for this product is 36 months. See General Terms and Conditions of Sales for further details.

Under current Italian and European laws, Datalogic is not obliged to take care of product disposal at the end of its life. Datalogic recommends disposing of the product in compliance with local laws or contacting authorised waste collection centres.

© 2009 - 2017 Datalogic S.p.A. and/or its affiliates • ALL RIGHTS RESERVED. • Without limiting the rights under copyright, no part of this documentation may be reproduced, stored in or introduced into a retrieval system, or transmitted in any form or by any means, or for any purpose, without the express written permission of Datalogic S.p.A. and/or its affiliates. Datalogic and the Datalogic logo are registered trademarks of Datalogic S.p.A. in many countries, including the U.S.A. and the E.U. All other trademarks and brands are property of their respective owners. Datalogic reserves the right to make modifications and improvements without prior notification.