

manuale d'installazione ed uso • installation and use manual • installations- und bedienungsanleitung
manuel d'installation et d'utilisation • manual de instalación y uso

SENTINEL POWER GREEN

SPM 6
SPH 8-10-15-20
SPH 10-20 ER



INTRODUCTION

Congratulations on purchasing a **UPS Sentinel Power Green** product and welcome to **Riello UPS**! To use the support service offered by **Riello UPS**, visit the site **www.riello-ups.com**

The company is highly specialised in the development and production of uninterruptible power supplies (UPSs). The UPSs in this series are high-quality products, carefully designed and manufactured in order to ensure the highest levels of performance.

This device can be installed by anyone on the condition that he/she has **READ THE USER AND SAFETY MANUAL CAREFULLY.**

The UPS and the Battery Box internally generate DANGEROUS electrical voltages. All maintenance operations must be carried out SOLELY by qualified operators.

This manual contains detailed instructions for using and installing the UPS and the Battery box. **For information on how to use and maximise the performance of your device, please retain this manual and read it carefully before operating the device.**

ENVIRONMENTAL PROTECTION

In the development of its products, the company devotes abundant resources to analysing the environmental aspects. All our products pursue the objectives defined in the environmental management system developed by the company in compliance with applicable standards.

No hazardous materials such as CFCs, HCFCs or asbestos are used in this product.

When evaluating packaging, the choice of material has been made favouring recyclable materials. For correct disposal, please separate and identify the type of material of which the packaging is made in the table below. Dispose of all material in compliance with applicable standards in the country in which the product is used.

DESCRIPTION	MATERIAL
Box	Cardboard
Packaging corner	Expanded polystyrene
Protective bag	Polythene
Accessories bag	Polythene
Pallet	Wood + expanded polystyrene
Slide	Wood

DISPOSING OF THE PRODUCT

The UPS and the Battery Box contain electronic cards and batteries which are considered TOXIC and HAZARDOUS waste. When the product reaches the end of its operating life, dispose of it in accordance with applicable local legislation. Disposing of the product correctly contributes to respecting the environment and personal health.

© The reproduction of any part of this manual, in whole or in part, is forbidden without the prior consent of the manufacturer. In order to make improvements, the manufacturer reserves the right to modify the product described at any moment and without notice.

CONTENTS

PRESENTATION	47
UPS VIEWS	48
FRONT VIEW (ALL MODELS)	48
REAR VIEW (SPM 6)	49
REAR VIEW (SPH 8 - 10 - 10 ER)	50
REAR VIEW (SPH 15 - 20 - 20 ER)	51
DISPLAY PANEL VIEW	52
BATTERY BOX (OPTIONAL)	53
REAR VIEW	53
INSTALLATION	54
REMOVING THE UPS OR THE BATTERY BOX FROM THE PALLET	54
INITIAL CONTENT CHECK	55
INSTALLATION ENVIRONMENT	56
BATTERY BOX INSTALLATION	56
VERSIONS SPM 6, SPH 8 -10 - 10 ER	56
VERSIONS SPH 15 - 20 - 20 ER	57
SETTING THE NOMINAL BATTERY CAPACITY	58
CONNECTIONS	59
SINGLE-PHASE VERSION	60
COMBINED VERSION	61
SINGLE-PHASE CONNECTION	61
THREE-PHASE CONNECTION	62
REMOTE CONTROL TERMINAL BLOCK	63
REMOTE BYPASS FOR MAINTENANCE	63
R.E.P.O.	64
USE	65
CONNECTIONS AND SWITCHING ON FOR THE FIRST TIME	65
SWITCHING ON FROM THE MAINS	65
SWITCHING ON FROM THE BATTERY	65
SWITCHING OFF THE UPS	65
DISPLAY PANEL MESSAGES	66
UPS STATUS MESSAGES	66
MEASUREMENT DISPLAY AREA	67

CONFIGURING THE OPERATING MODE	69
<i>POSSIBLE SETTINGS</i>	69
<i>ADDITIONAL FUNCTIONS</i>	69
SOFTWARE	71
<i>MONITORING AND CONTROL SOFTWARE</i>	71
<i>CONFIGURATION SOFTWARE</i>	71
UPS CONFIGURATION	72
COMMUNICATION PORTS	74
<i>RS232 CONNECTOR</i>	74
<i>COMMUNICATION SLOT</i>	74
<u>TROUBLESHOOTING</u>	<u>75</u>
<i>ALARM CODES</i>	77
<i>FAULT</i>	77
<i>LOCK</i>	79
<u>TECHNICAL DATA</u>	<u>80</u>

PRESENTATION

SENTINEL POWER GREEN uses ON-LINE double conversion technology, resulting in the highest levels of reliability and maximum protection for critical loads such as servers, IT applications and Voice/Data.

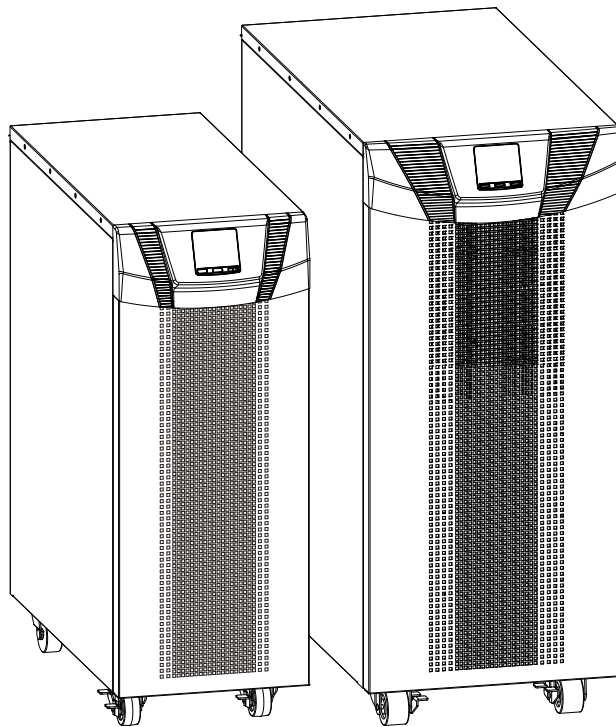

Only for versions SPM 6, SPH 8 - 10 and 10 ER, it is possible to use one or more autonomy expansion units known as **BATTERY BOXES** (optional accessories) with the same dimensions and aesthetic line as the UPS alongside it.

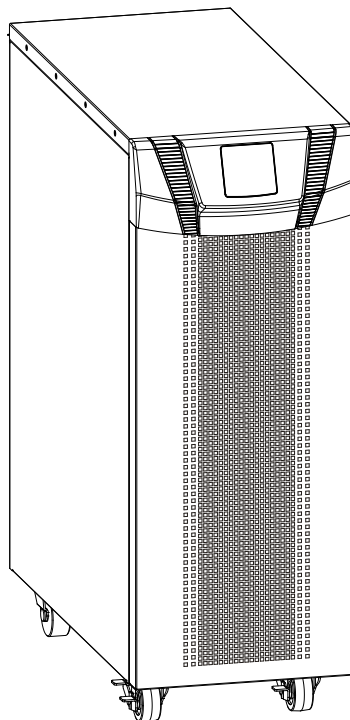

The **ER model** UPSs fitted with upgraded battery chargers are the solution for Business Continuity applications which require long battery-powered operating times. For these versions, the batteries are housed in separate cabinets which are designed to contain large, high-capacity batteries.

UPS VIEWS

FRONT VIEW (ALL MODELS)

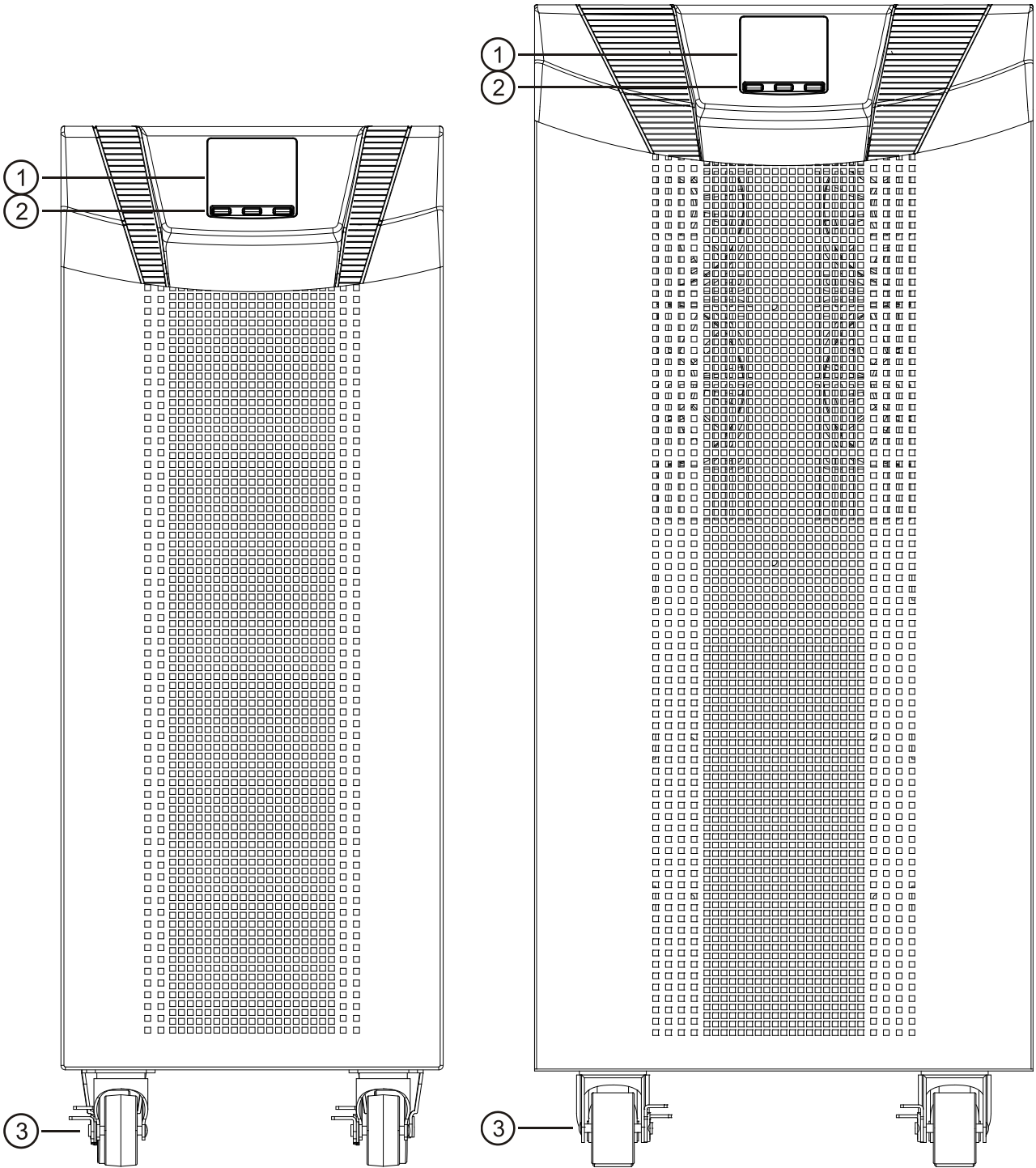

- ① Display
- ② Multipurpose buttons
- ③ Wheels (front wheels swivel and can be locked, fixed rear wheels)

REAR VIEW (SPM 6)

With backpack

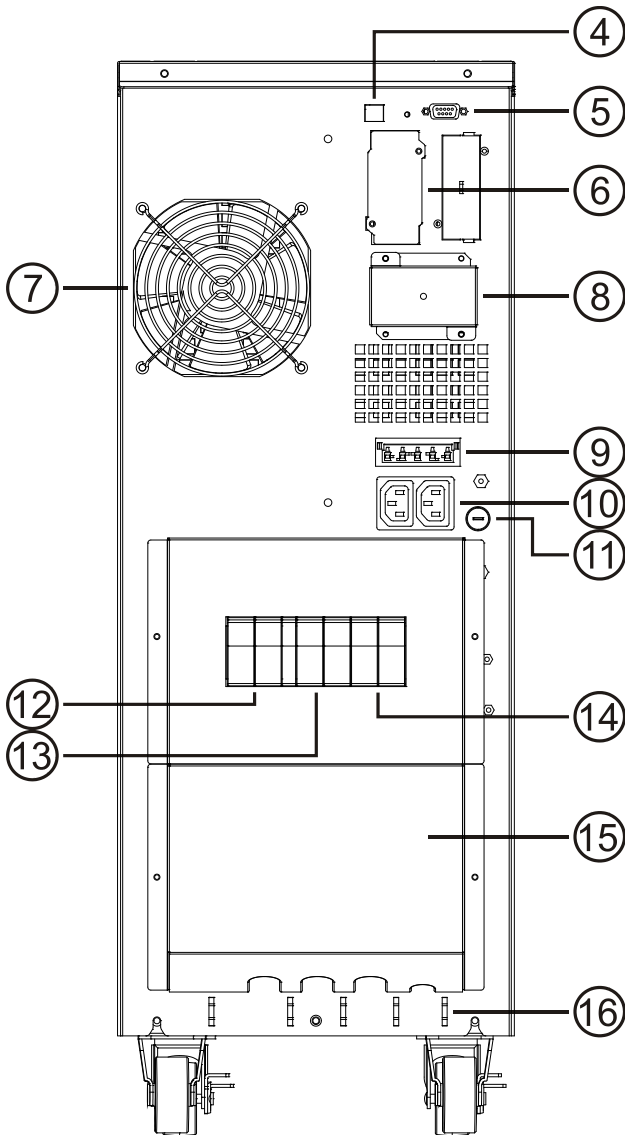

Without backpack

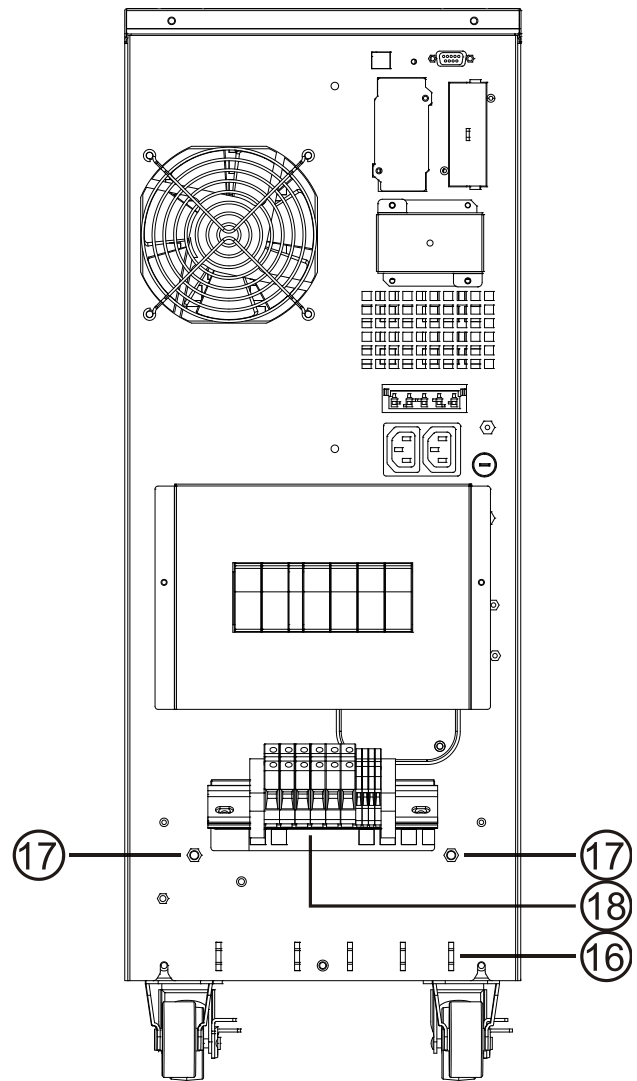

- ④ USB communication port
- ⑤ RS232 communication port and contacts
- ⑥ Intelligent Slot
- ⑦ Cooling fans
- ⑧ Parallel port (optional)
- ⑨ Battery expansion connector
- ⑩ Energy Share socket
- ⑪ Energy Share Fuse

- ⑫ Input switch
- ⑬ Manual bypass for maintenance
- ⑭ Output switch
- ⑮ Terminals cover backpack
- ⑯ Tie wrap hold-down
- ⑰ Earthing screws
- ⑱ Terminals for I/O cable connection (refer to related section)

REAR VIEW (SPH 8 - 10 - 10 ER)

With backpack

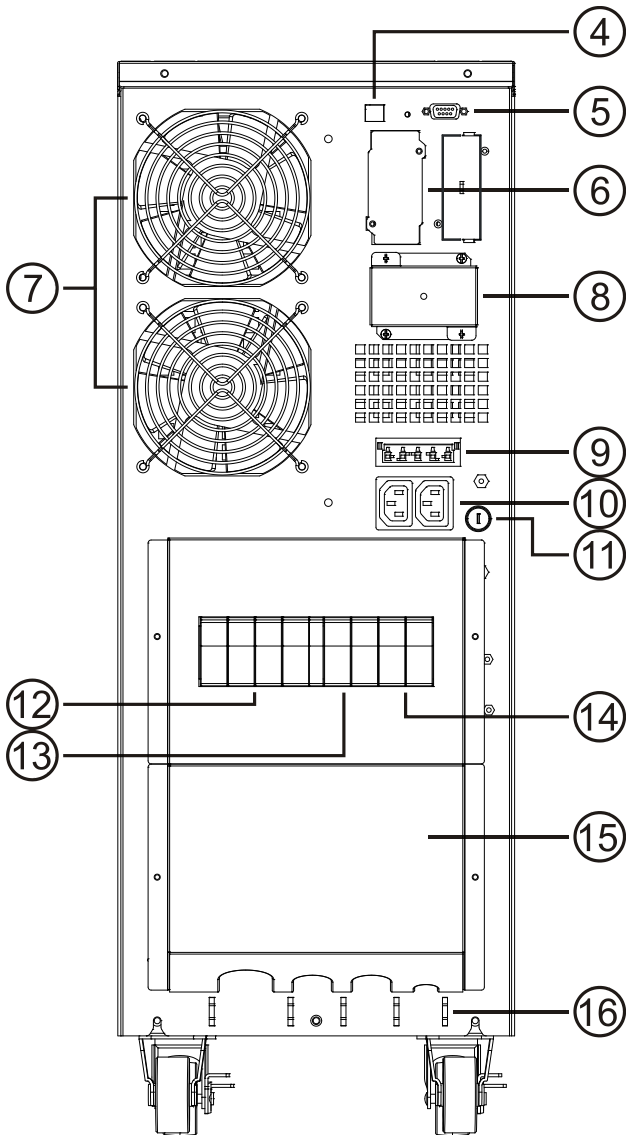

Without backpack

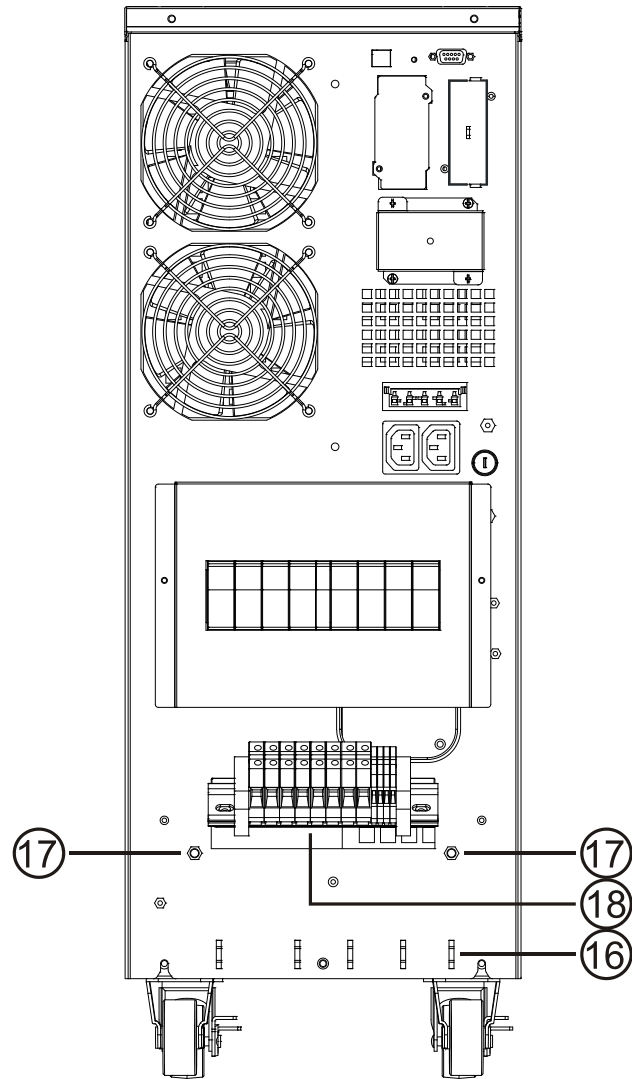

- ④ USB communication port
- ⑤ RS232 communication port and contacts
- ⑥ Intelligent Slot
- ⑦ Cooling fans
- ⑧ Parallel port (optional)
- ⑨ Battery expansion connector
- ⑩ Energy Share socket
- ⑪ Energy Share Fuse

- ⑫ Input switch
- ⑬ Manual bypass for maintenance
- ⑭ Output switch
- ⑮ Terminals cover backpack
- ⑯ Tie wrap hold-down
- ⑰ Earthing screws
- ⑱ Terminals for I/O cable connection (refer to related section)

REAR VIEW (SPH 15 - 20 - 20 ER)

With backpack

Without backpack

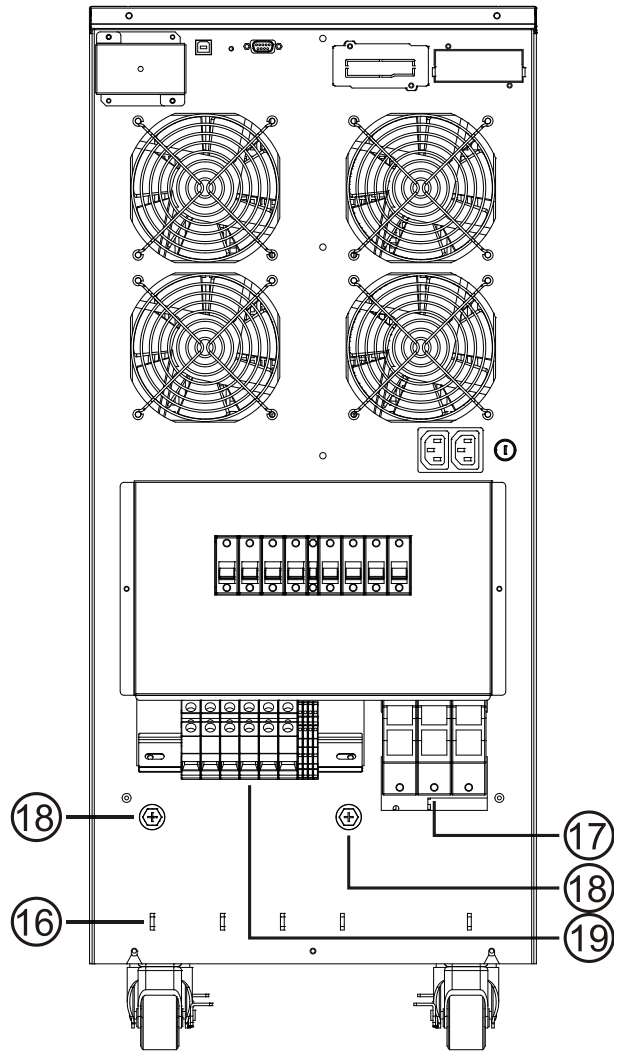
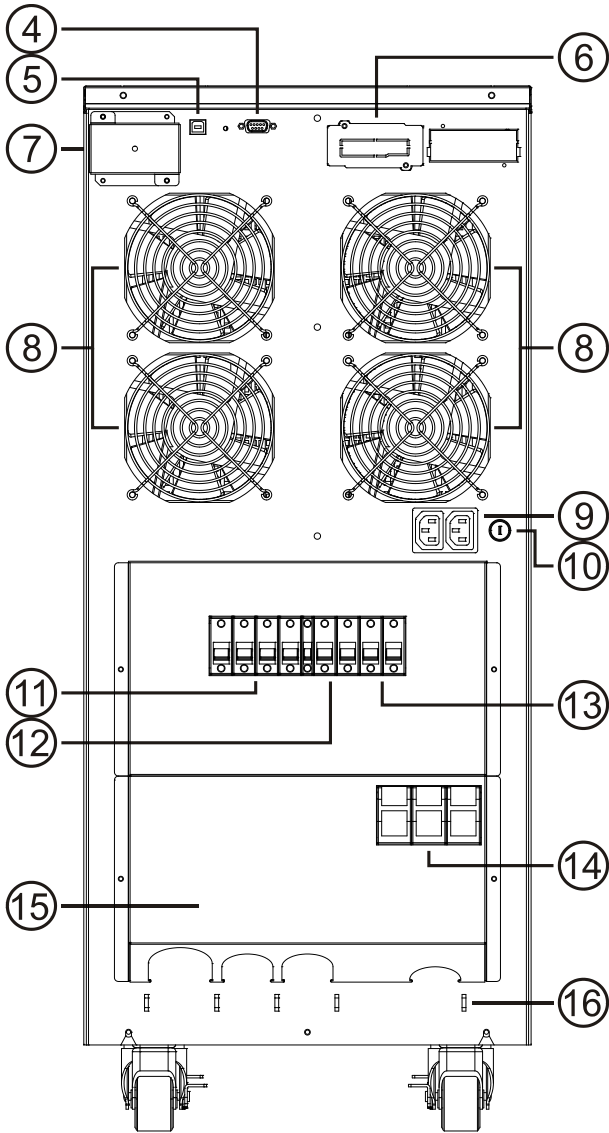

- ④ RS232 communication port and contacts
- ⑤ USB communication port
- ⑥ Intelligent Slot
- ⑦ Parallel port (optional)
- ⑧ Cooling fans
- ⑨ Energy Share socket
- ⑩ Energy Share Fuse
- ⑪ Input switch

- ⑫ Manual bypass for maintenance
- ⑬ Output switch
- ⑭ Battery expansion fuses
- ⑮ Terminals cover backpack
- ⑯ Tie wrap hold-down
- ⑰ Battery expansion terminals (refer to related section)
- ⑱ Earthing screws
- ⑲ Terminals for I/O cable connection (refer to related section)

DISPLAY PANEL VIEW

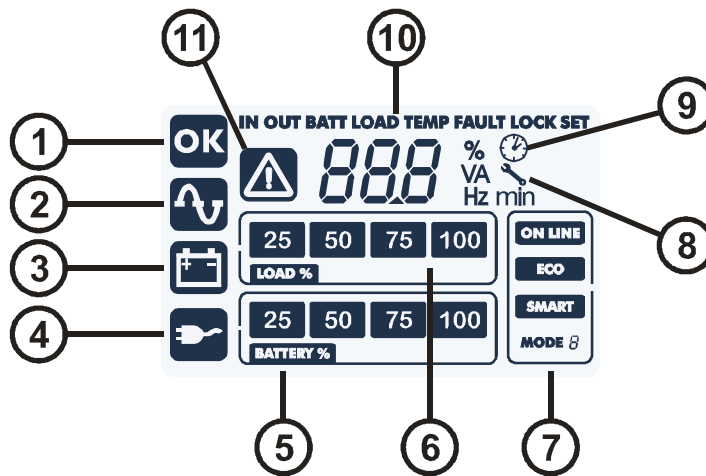

- | | |
|--------------------------|----------------------------|
| Ⓐ "SEL" button (Select) | Ⓔ Battery charge indicator |
| Ⓑ "ON" button | Ⓕ Load level indicator |
| Ⓒ "STAND-BY" button | Ⓖ Configuration area |
| ① Regulation operation | ⑧ Maintenance request |
| ② Mains operation | ⑨ Timer |
| ③ Battery operation | ⑩ Measurement display area |
| ④ Load powered by bypass | ⑪ Stand-by / alarm |

BATTERY BOX (OPTIONAL)

The BATTERY BOX is an optional accessory dedicated to this range of UPSs (same dimensions and aesthetic line). The BATTERY BOX contains batteries which allow the operating time of the uninterruptible power supplies to be increased during extended blackouts. The number of batteries contained can vary according to the type of UPS for which the BATTERY BOX is intended. It is therefore necessary to take great care to ensure that the battery voltage of the BATTERY BOX is the same as the voltage permitted by the UPS.

It is possible to connect further BATTERY BOXES in order to create a chain, suitable for achieving any autonomy time without mains power.

REAR VIEW

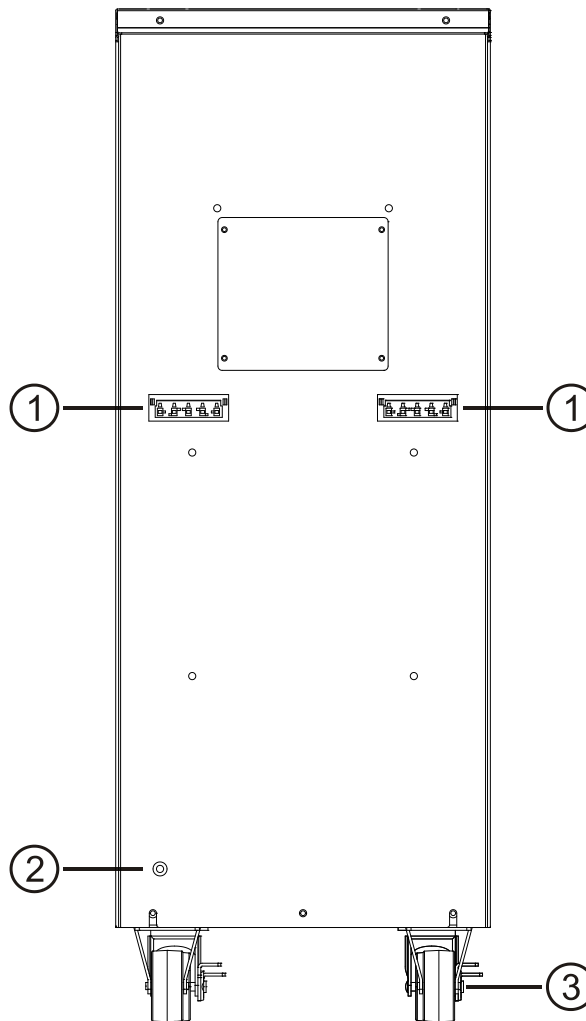

- ① Battery expansion connector
- ② Screw for earth connection
- ③ Wheels (front wheels swivel and can be locked, fixed rear wheels)

INSTALLATION

REMOVING THE UPS OR THE BATTERY BOX FROM THE PALLET

- Cut the straps and carefully remove the cardboard box by sliding it upwards.
- Remove the accessory box, the wooden slide and the top polystyrene foam corner pieces.

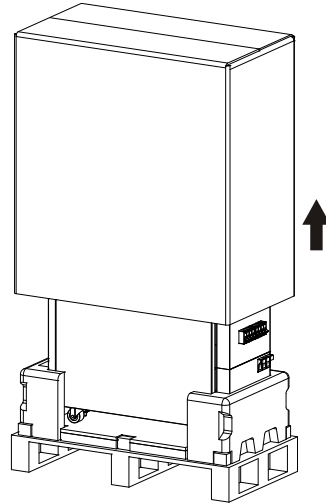

- Remove the bottom polystyrene corner pieces by rotating them as shown in the figure.
- Open the protective bag and pull it all the way down.

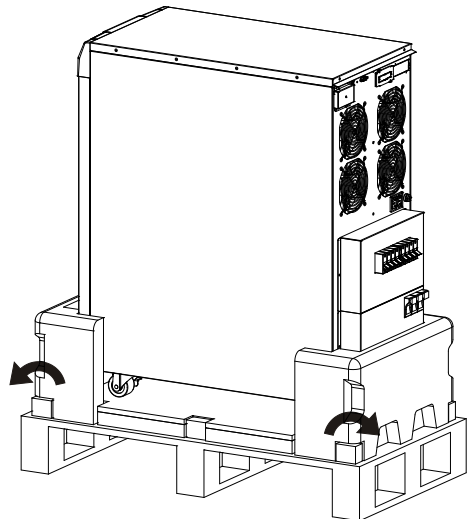

- Put the previously removed slide on the back part of the pallet (see figure). Make sure that the slide rests firmly against the pallet so it remains in place during unloading operations. Push the UPS from the front and exercise extreme caution when sliding it off the pallet.

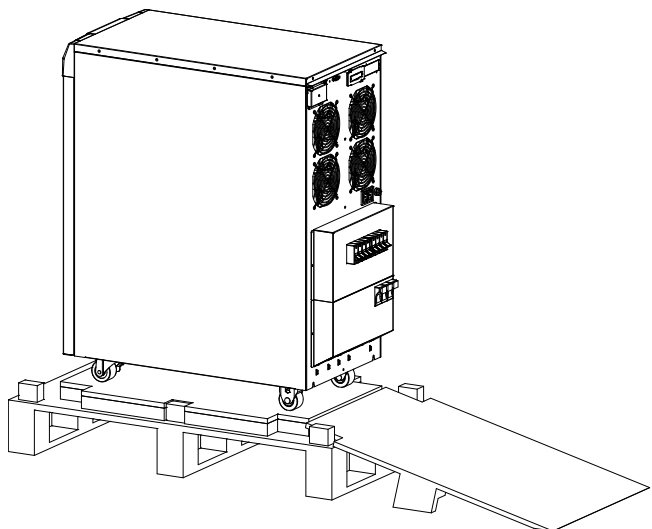

NOTE: All parts of the packaging should be kept for future use.

INITIAL CONTENT CHECK

After opening the packaging, it is first necessary to check the contents.
The package must contain:

UPS

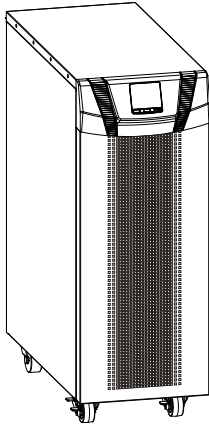

USB cable

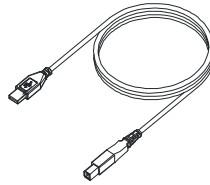

RS232 cable

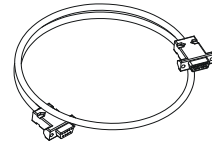

Slide

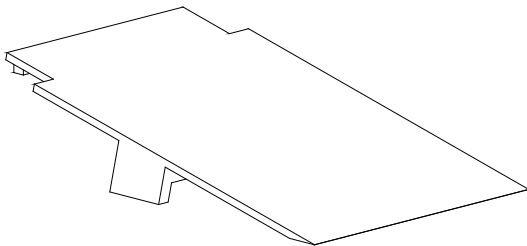

User manual + Safety manual

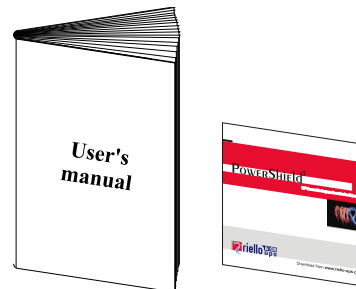

INSTALLATION ENVIRONMENT

The UPS and the Battery Box must be installed in ventilated, clean environments which are sheltered from bad weather. The relative humidity in the environment must not exceed the maximum values shown in the Technical Data table. The ambient temperature, whilst the UPS is in operation must remain between 0 and 40°C, and the UPS must not be positioned in places which are exposed to direct sunlight or to hot air.



The recommended operating temperature for the UPS and the batteries is between 20 and 25°C. The actual operating life of the batteries is 5 years on average with an operating temperature of 20°C. If the operating temperature reaches 30°C, the operating life is halved.

BATTERY BOX INSTALLATION



CAUTION:
CHECK THAT THE BATTERY BOX VOLTAGE IS THE SAME AS THE VOLTAGE PERMITTED BY THE UPS.
CHECK THE RATING ON THE BACK OF THE DEVICE.

VERSIONS SPM 6, SPH 8 -10 - 10 ER

It is possible to connect more than one Battery Box in order to achieve any level of autonomy without mains power. Connect any Battery Boxes in a cascade as shown in the figure below:

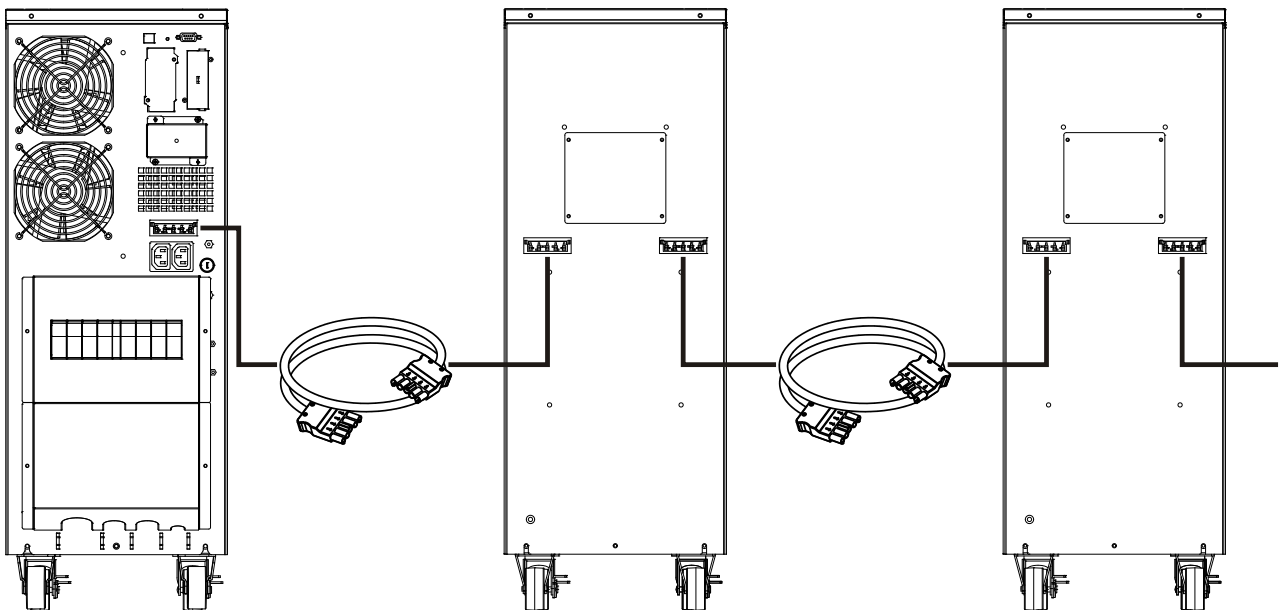

VERSIONS SPH 15 - 20 - 20 ER

The terminals to use for connecting the external batteries are located in the backpack. Unscrew the two screws used to secure the lower part of the backpack located on the sides (one on each side, see figure).

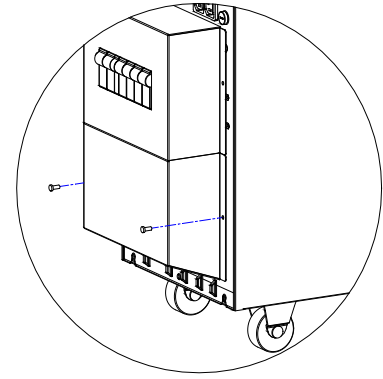

Lift the back-pack off (see figure to the side).

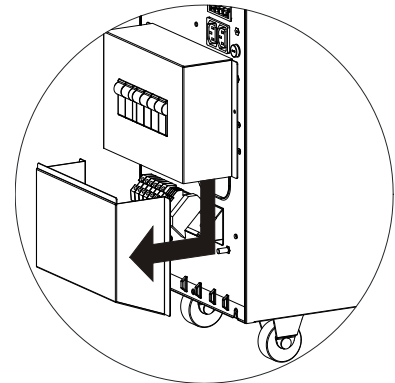

3. CONNECTION: Use 3 cables with 25 mm² section (+, N and -)

4. Connect the wires to the relative terminals, following exactly the instructions given below:

- a - Make sure that the isolator of the external battery box is open.
- b - Connect the positive branch wire to terminal 11.
- c - Connect the neutral wire to terminal 12.
- d - Connect the negative branch wire to terminal 13.

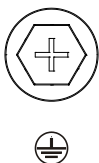
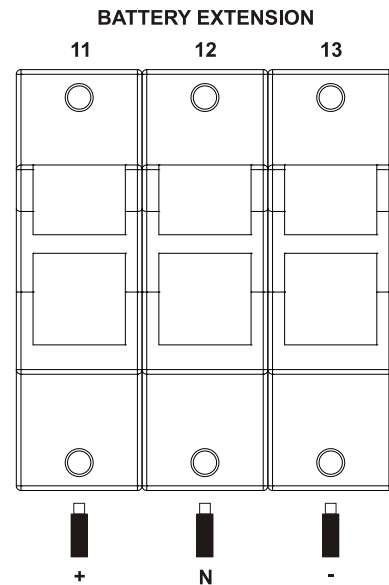
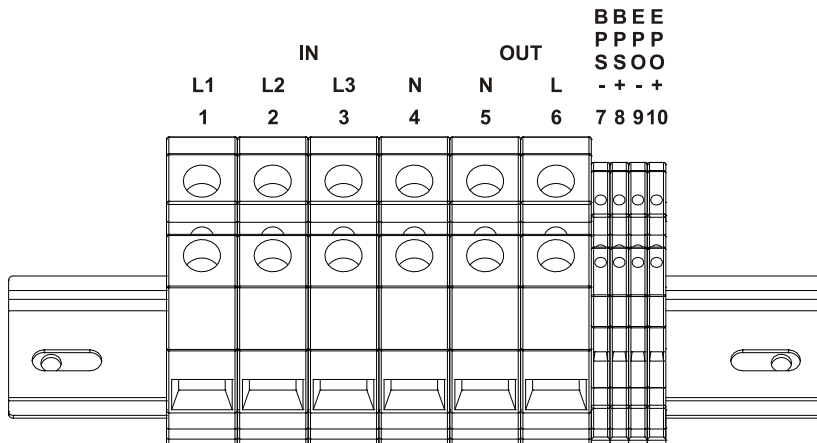

SETTING THE NOMINAL BATTERY CAPACITY

Before installing one or more Battery Boxes, configure the UPS to update the rated capacity value (total Ah of batteries in the UPS + external batteries). Use the dedicated **UPSTools** configuration software, available free of charge at www.riello-ups.com, to perform this operation. The battery box must be installed while the UPS is switched off and disconnected from the main.



CAUTION:

The connection cables cannot be extended by the user (only for versions SPM 6, SPH 8 - 10 - 10 ER).

After connecting the UPS to its Battery Boxes, insert the fuses and turn the Battery Box battery switches to the ON position (only for versions SPH 15 - 20 - 20 ER).

It is not possible to connect more than one UPS to a single battery box, or to several Battery Boxes connected in a series.

CONNECTIONS

INSTALLATION MUST ONLY BE PERFORMED BY QUALIFIED PERSONNEL.

THE FIRST CONNECTION TO PERFORM IS THAT OF THE PROTECTIVE CONDUCTOR (EARTH CABLE), WHICH MUST BE CONNECTED TO THE SCREW MARKED ⊕

THE UPS MUST NEVER BE MADE OPERATE WITHOUT A CONNECTION TO THE EARTHING SYSTEM.

Warning: providing it complies with the neutral (N) and phase (F) indications for plugs and sockets, the UPS, when inserted in an installation, does not alter the existing neutral arrangements. The resistance on the neutral connection must be less than 0.1 ohm.

A differential switch upstream will also be triggered for a fault occurring downstream of the UPS. In calculating reactivity of this switch, account must be taken of the leakage current of the UPS (approx. 2 mA) plus that of the load which come together on the UPS's earth conductor.

UPS input	Differential switch
Single-phase	Type B or Type A
Three-phase	Type B

The neutral arrangements are altered only if there is also an isolating transformer or when the UPS operates with a neutral that is disconnected upstream.

In any case avoid connecting the output neutral with the input neutral or to the earth as this could damage the UPS.

To make the mains power and load connections, follow the instructions below:

1. Install a magneto-thermal switch (63A for versions SPM 6, SPH 8 - 10 - 10 ER; 125A for versions SPH 15 - 20 - 20 ER) with intervention curve B or C upstream of the machine (4 poles for three-phase versions, 2 poles for single-phase versions).

2. The connection terminals to use for the input and output lines are located in the backpack. Unscrew the two screws used to secure the lower part of the backpack located on the sides (one on each side, see figure).

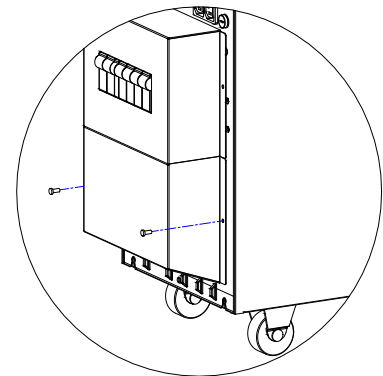

3. Lift the back-pack off (see figure to the side).

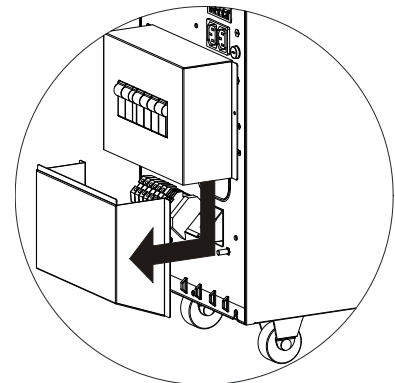

SINGLE-PHASE VERSION

4. (SINGLE-PHASE CONNECTION SPM 6): use 3 cables with cross-section 6 mm² (EARTH, N and L) for the input, and 3 cables with cross-section 6 mm² for the output (EARTH, N and L).

5. Connect the wires to the relative terminals, following exactly the instructions given below:

Input line

a - Make sure that the magneto-thermal switch upstream is open.

b - Connect the earth wire to screw A.

c - Connect the neutral wire to terminal 2.

d - Connect the live wire to terminal 1.

Output line

a - Connect the earth wire to screw B.

b - Connect the neutral wire to terminal 3.

c - Connect the live wire to terminal 4.

Remote By-pass

a - Make sure that a jumper is connected between terminals 5 and 6, needed for proper operation of the UPS.

R.E.P.O.

a - Make sure that a jumper is connected between terminals 7 and 8, needed for proper operation of the UPS.

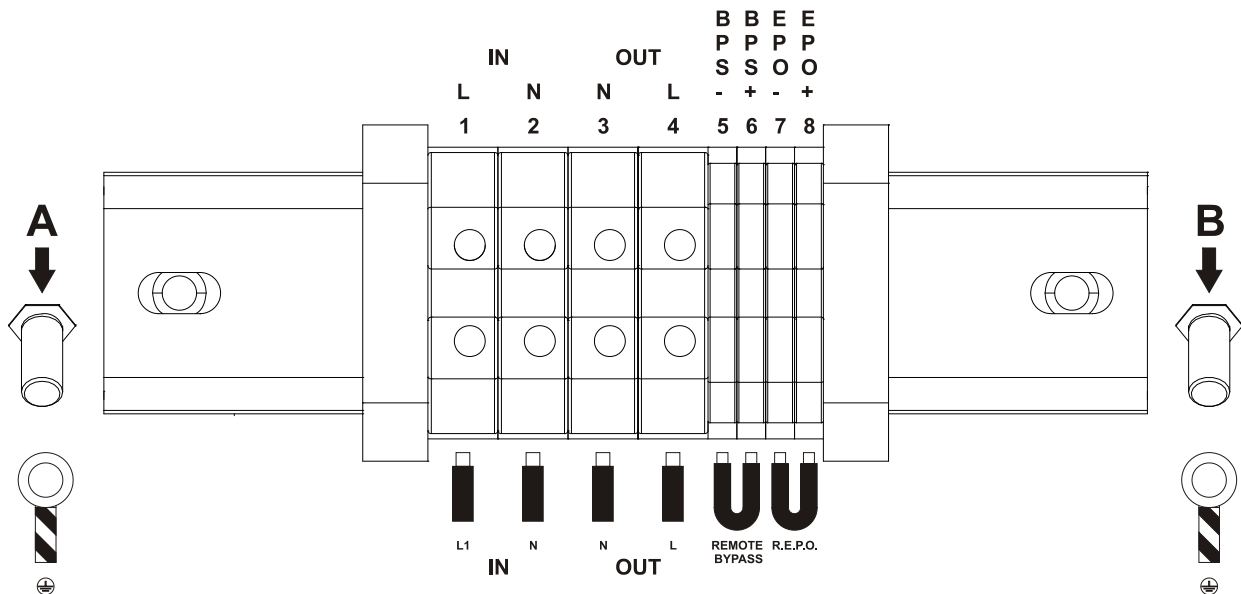

6. Tighten the terminals well, close the back-pack and secure it with the screws taken out earlier.

COMBINED VERSION

SINGLE-PHASE CONNECTION

4. (SINGLE-PHASE CONNECTION SPH 8 - 10 - 10 ER): use 3 cables of cross-section 10 mm² (EARTH, N and L) for the input, and 3 cables of cross-section 10 mm² for the output(EARTH, N and L).

(SINGLE-PHASE CONNECTION SPH 15): use 3 cables of cross-section 16 mm² (EARTH, N and L) for the input, and 3 cables of cross-section 16 mm² for the output(EARTH, N and L).

(SINGLE-PHASE CONNECTION SPH 20 - 20 ER): use 3 cables of cross-section 25 mm² (EARTH, N and L) for the input, and 3 cables of cross-section 25 mm² for the output(EARTH, N and L).

5. Short-circuit the input terminals (1, 2 and 3) with the jumper provided in the accessories kit. Connect the wires to the respective terminals, following exactly the instructions below:

Input line

- a - Ensure that the upstream magneto-thermal switch is open.
- b - Connect the earth wire to screw A.
- c - Connect the neutral wire to terminal 4.
- d - Connect the live wire to terminal 1.

Output line

- a - Connect the earth wire to screw B.
- b - Connect the neutral wire to terminal 5.
- c - Connect the live wire to terminal 6.

Remote By-pass

- a - Ensure that a jumper is connected on terminals 7 and 8, this is necessary for correct operation of the UPS.

R.E.P.O.

- a - Ensure that a jumper is connected on terminals 9 and 10, this is necessary for correct operation of the UPS.

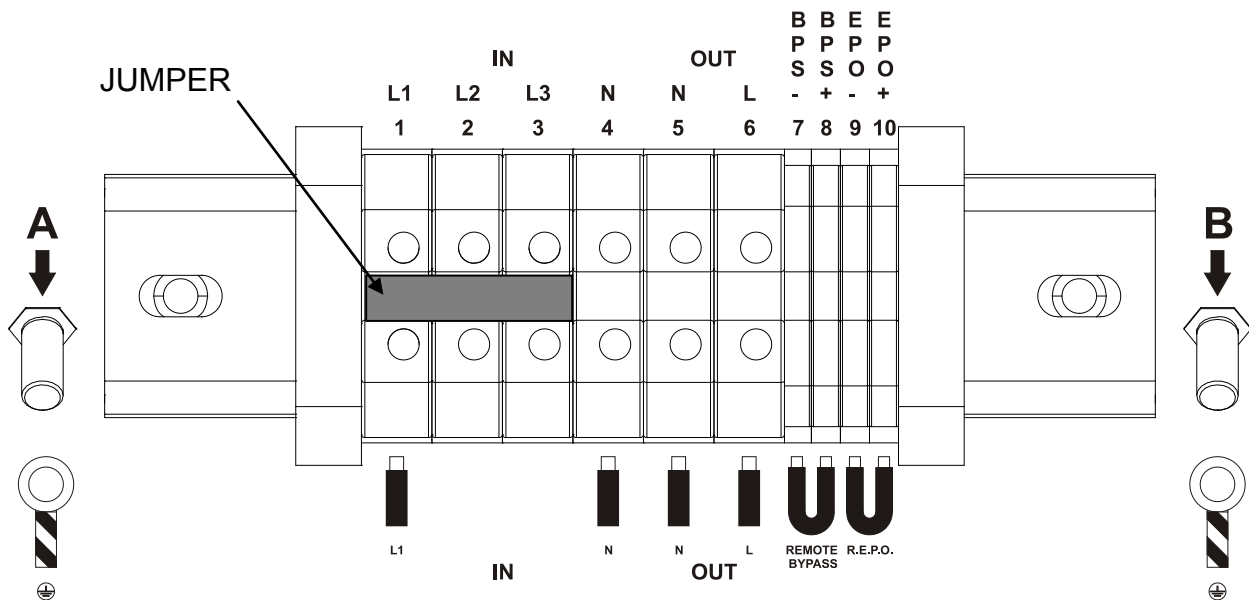

- 6. Tighten the terminals well, close the back-pack and secure it with the screws taken out earlier.
- 7. Configure the single-phase configuration using the configuration software (see paragraph **Configuration software**).

THREE-PHASE CONNECTION

4. (**THREE-PHASE CONNECTION SPH 8 - 10 - 10 ER**): Use 2 cables of cross-section 4 mm² (L2 and L3) and 3 with cross-section 10 mm² (EARTH, N, L1) for the input (N.B.: L1 and N are of greater cross-section because in bypass operation they have to carry all of the input current). For the output use 3 cables of cross-section 10 mm² (EARTH, N and L).

(**THREE-PHASE CONNECTION SPH 15**): Use 2 cables of cross-section 4 mm² (L2 and L3) and 3 of cross-section 16 mm² (EARTH, N, L1) for the input (N.B.: L1 and N are of greater cross-section because in bypass operation they have to carry all of the input current). For the output use 3 cables of cross-section 16 mm² (EARTH, N and L).

(**THREE-PHASE CONNECTION SPH 20**): Use 2 cables of cross-section 6 mm² (L2 and L3) and 3 of cross-section 25 mm² (EARTH, N, L1) for the input (N.B.: L1 and N are of greater cross-section because in bypass operation they have to carry all of the input current). For the output use 3 cables of cross-section 25 mm² (EARTH, N and L).

5. Connect the wires to the respective terminals, following exactly the instructions below:

Input line

- Ensure that the upstream magneto-thermal switch is open.
- Connect the earth wire to screw A.
- Connect the neutral wire to terminal 4.
- Connect the wires of the phases to terminals 1, 2 and 3 (for L1 use red wire).

Output line

- Connect the earth wire to screw B.
- Connect the neutral wire to terminal 5.
- Connect the live wire to terminal 6.

Remote By-pass

- Ensure that a jumper is connected on terminals 7 and 8, this is necessary for correct operation of the UPS.

R.E.P.O.

- Ensure that a jumper is connected on terminals 9 and 10, this is necessary for correct operation of the UPS.

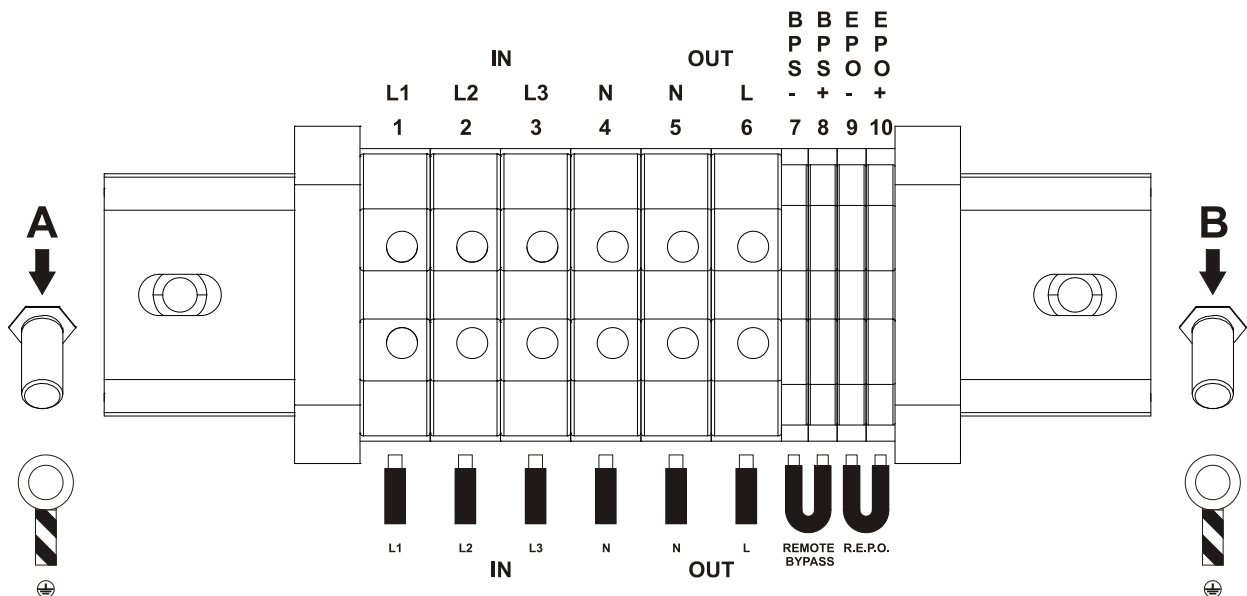

6. Tighten the terminals well, close the back-pack and secure it with the screws taken out earlier.

A WARNING LABEL MUST BE PUT ON ALL MAINS POWER DISCONNECTING SWITCHES INSTALLED REMOTE FROM THE AREA OF THE UPS, IN ORDER TO ALERT ALL SERVICE OPERATORS THAT THE CIRCUIT IS CONNECTED TO A UPS. THE LABEL MUST BEAR THE FOLLOWING WORDING:

**ISOLATE THE UPS
BEFORE WORKING ON THIS CIRCUIT**

REMOTE CONTROL TERMINAL BLOCK

REMOTE BYPASS FOR MAINTENANCE

To be able to control the remote maintenance By-Pass externally, follow points 1, 2 and 3 described above. Then proceed as follows:

1. Use a $2 \times 0.75 \text{mm}^2$ cable to make the connection with the remote bypass terminals.
2. Connect the two cable leads to terminals 5 and 6 (For version SPM 6), 7 and 8 (For version SPH 8 - 10 - 10 ER - 15 - 20 - 20 ER) to properly control the remote By-pass externally.

SPM 6

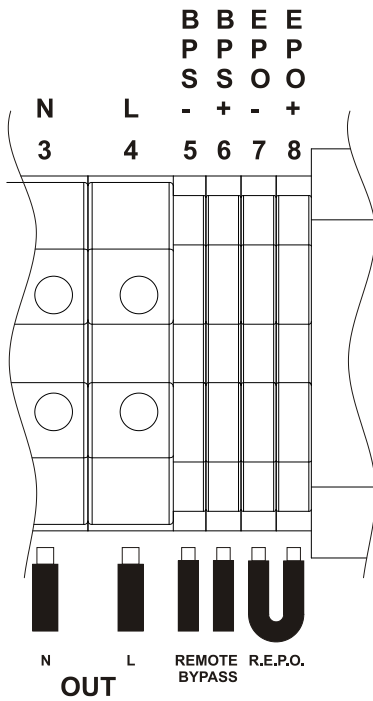

SPH 8 - 10 - 10 ER - 15 - 20 - 20 ER

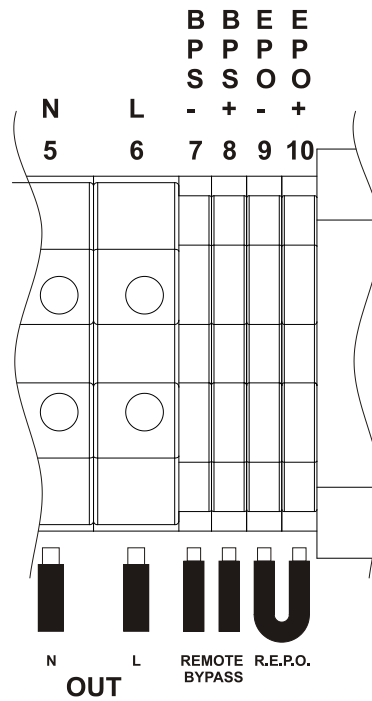

3. Tighten the terminals well, close the back-pack and secure it with the screws taken out earlier.

Note: The Remote Bypass function can be used with the UPS in both the single-phase and three-phase configuration.

R.E.P.O.

The terminal block on the back of the UPS also implements the R.E.P.O. (Remote Emergency Power Off) function that can be used to shut off the UPS remotely in case of an emergency.

The UPS is provided by the manufacturer with the REPO terminals short-circuited. For installation remove the short circuit and connect to the device's normally closed contact
In case of an emergency, if the stop device is used, the REPO control is opened and the UPS goes into stand-by mode and the load is completely disconnected.

Attention: before restarting the UPS, reset the stop device.

The circuitry of the remote control terminal board is self-powered with SELV circuits. Therefore, an external voltage supply is not required. When a contact is closed, a maximum current of 15mA circulates.
All connections with the remote control terminal board are made through a cable which guarantees a double insulation connection.

If you would like to bring the R.E.P.O. control outside, unscrew the two screws securing the lower part of the backpack and remove it (as indicated in the section "Connections"). Then, proceed as follows:

1. Use a 2x0.75mm² cable to make the connection with the R.E.P.O. terminals.
2. Connect the two wires of the cable to terminals 7 and 8 (for version SPM 6), 9 and 10 (for versions SPH 8 - 10 - 10 ER - 15 - 20 - 20 ER) so as to be able to remotely shut off the UPS.

SPM 6

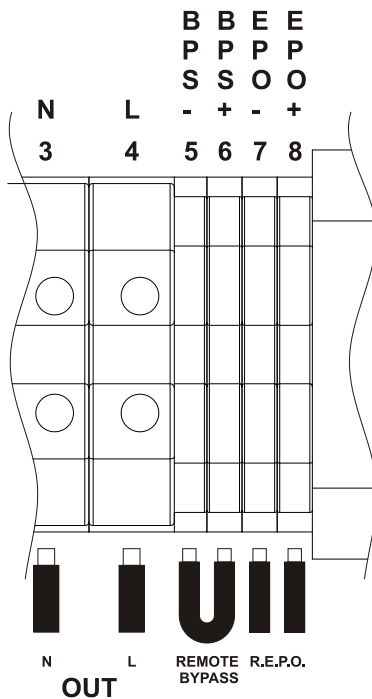

SPH 8 - 10 - 10 ER - 15 - 20 - 20 ER

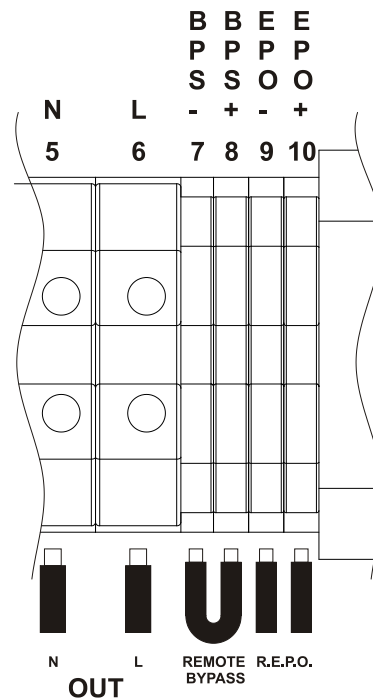

3. Tighten the terminals well, close the back-pack and secure it with the screws taken out earlier.

CONNECTIONS AND SWITCHING ON FOR THE FIRST TIME

- 1) Check that there is a protection device against overcurrents and short circuits in the system upstream from the UPS. The recommended protection value is 63A (For versions SPM 6, SPH 8 - 10 - 10 ER) and 125A (For versions SPH 15 - 20 - 20 ER) with a B or C trip curve.
- 2) Close the magnetothermic switch located upstream of the UPS.
- 3) Press Close the input and output switches and insert the battery fuses (if any) located on the back of the UPS's backpack.
- 4) After a few moments, the UPS will switch on, the display will light up, there will be a beep and the  icon will start to flash. The UPS is in stand-by mode: meaning that it is only consuming a small amount of power. The microcontroller is powered which supervises the self-diagnoses; the batteries are charging; everything is ready for UPS activation. Battery operation is also in stand-by mode provided that the timer is active.
- 5) Check which operating mode is set on the display and, if necessary, see the **"Configuring operating modes"** paragraph to set the required mode. For advanced UPS configurations execute the software UPSTools which can be downloaded from the web site www.riello-ups.com.

SWITCHING ON FROM THE MAINS

- 1) Press the "ON" button for 1 second. After pressing it, all the icons on the display light up for 1 second and the UPS beeps.
- 2) Switch on the equipment connected to the UPS.

When switching on for the first time only: after 30 seconds, check that the UPS is operating correctly:

- 1) Simulate a blackout by disconnecting power to the UPS.
- 2) The load must continue to be powered, the  icon on the display must light up and there must be a beep every 4 seconds.
- 3) When power is reconnected, the UPS must go back to operating from the mains.

SWITCHING ON FROM THE BATTERY

- 1) Hold down the "ON" button for at least 5 seconds. All the icons on the display light up for 1 second.
- 2) Switch on the equipment connected to the UPS.

SWITCHING OFF THE UPS









In order to switch off the UPS, hold down the "STBY" button for at least 2 seconds. The UPS goes back to stand-by mode and the  icon starts to flash:

- 1) If mains power is present, to switch off the UPS completely open the input isolator and the UPS will shut down after 14 seconds.
- 2) During battery mode operation with the timer not set, the UPS automatically switches off after 30 seconds. If, on the contrary, the timer is set, press and hold down the "STBY" key for at least 5 seconds to turn off the UPS. For complete shutdown, open the input switch.

DISPLAY PANEL MESSAGES

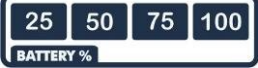
This chapter describes, in detail, the various information that can be displayed on the LCD.

UPS STATUS MESSAGES











ICON	STATUS	DESCRIPTION
	Fixed	Indicates a fault
	Flashing	The UPS is in stand-by mode
	Fixed	Indicates regular operation
	Fixed	The UPS is operating from the mains
	Flashing	The UPS is operating from the mains, but the output voltage is not synchronised with the mains voltage
	Fixed	The UPS is operating from the battery. In this condition, the UPS emits an acoustic signal (beep) at regular 4-second intervals.
	Flashing	Low battery pre-alarm. Indicates that battery autonomy is coming to an end. In this condition, the UPS emits a beep at regular 1-second intervals.
	Fixed	Indicates that the loads connected to the UPS are powered by the bypass
	Dynamic	Indicates the estimated percentage charge of the batteries
	Dynamic	Indicates the percentage of charge applied to the UPS compared with the nominal value.
	Flashing	Maintenance is required. Contact the support centre.
	Fixed	Indicates that the timer is active (programmed switch-on and switch-off). The timer can be activated/deactivated using the software provided.
	Flashing	1 minute until the UPS switches back on or 3 minutes until it switches off

MEASUREMENT DISPLAY AREA

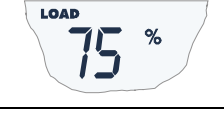
It is possible to display the most important measurements regarding the UPS in sequence on the display. When the UPS is switched-on, the display shows the main voltage value. To display a different measurement, press the "SEL" button repeatedly until the desired measurement appears. In the event of a fault/alarm (FAULT) or a lock (LOCK), the display will automatically show the type and code of the corresponding alarm.

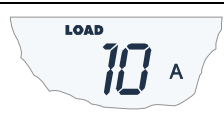
SINGLE-PHASE CONNECTION

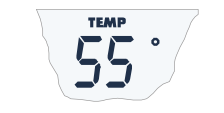
Some examples are shown below:

GRAPHIC EXAMPLE ⁽¹⁾	DESCRIPTION	GRAPHIC EXAMPLE ⁽¹⁾	DESCRIPTION
	Mains voltage		Battery charge percentage
	Mains frequency		Total battery voltage
	UPS output voltage		Applied load percentage
	Output voltage frequency		Current absorbed by the load
	Residual battery autonomy		Temperature of the electronics cooling system inside the UPS
	Fault / Alarm ⁽²⁾ : the corresponding code is displayed		Lock ⁽²⁾ : the corresponding code is displayed

⁽¹⁾ The values shown in the images in the table are purely as an indication.

⁽²⁾ The FAULT / LOCK codes can only be displayed if they are active (presence of a fault/alarm or a lock).

THREE-PHASE CONNECTION

Some examples are shown below:

GRAPHIC EXAMPLE ⁽¹⁾	DESCRIPTION	GRAPHIC EXAMPLE ⁽¹⁾	DESCRIPTION
	Voltage phase 1 ⁽²⁾		Percentage of battery charge
	Voltage phase 2 ⁽²⁾		Battery voltage ⁽⁴⁾
	Voltage phase 3 ⁽²⁾		Battery voltage ⁽⁴⁾
	UPS output voltage		Percentage of the applied load
	Output voltage frequency		Current absorbed by the load
	Residual battery back up time		Temperature of the cooling system for the UPS internal electronics
	Fault/Alarm ⁽³⁾ : the corresponding code is displayed		Lock ⁽³⁾ : the corresponding code is displayed

⁽¹⁾ The values shown in the images in the table are purely indicative.

⁽²⁾ Alternative indication Phase No./Voltage.

⁽³⁾ The FAULT/LOCK codes can only be displayed if they are active (i.e., if there is a fault/alarm or a lock).

⁽⁴⁾ Alternating indication, Battery branch no./ Voltage (for versions SPH 15 - 20 - 20 ER)

Steady indication, total battery voltage (for versions SPM 6, SPH 8 - 10 - 10 ER)

CONFIGURING THE OPERATING MODE

The area of the display shown in the figure displays the active operating mode and allows the user to choose other modes directly from the display panel.



HOW TO PROCEED:

- To access the configuration area, hold down the “SEL” button for at least 3 seconds.
- The “SEL” icon on the top right hand side of the display lights up.
- To change the mode, press the “ON” button.
- To confirm the mode chosen, hold down the “SEL” button for at least 3 seconds.

POSSIBLE SETTINGS

The UPS is designed to be configured in various operating modes:

- **ON-LINE** is the mode with the greatest load protection and the best quality of the output waveform (*)
- **ECO** is the mode with which the UPS consumes the least power, so is therefore the most efficient (**)
- **SMART ACTIVE:** in this mode, the UPS decides whether to operate in ON-LINE or ECO mode according to a statistic about the quality of the mains power.
- **STAND-BY OFF [Mode 1]:** the UPS operates as an emergency power supply. If mains power is present, the load is not powered, however should the mains supply fail, the load is powered by the UPS.

(*) The effective value (rms) of the output frequency and voltage is constantly controlled by the microprocessor, independently from the waveform of the mains voltage, maintaining the output frequency synchronised to the mains within a configurable range.
Outside this range, the UPS output de-synchronises from the mains supply, moving to the nominal frequency; in this condition, the UPS cannot use the bypass.

(**) In order to optimise performance, in ECO mode, the load is normally powered by the bypass. If the mains goes out of the permitted tolerance range, the UPS switches to ON LINE operation. If the mains returns within the permitted tolerance range for at least five minutes, the UPS goes back to powering the load from the bypass.

ADDITIONAL FUNCTIONS

MANUAL BYPASS

Using the Manual Bypass feature, the UPS can be switched to bypass. In this condition the load is powered directly by the input mains, any disruption in the mains directly affects the load.



CAUTION:
BEFORE CARRYING OUT THE FOLLOWING SEQUENCE OF OPERATIONS, ENSURE THAT THE UPS'S INPUT AND OUTPUT FREQUENCY COINCIDE AND THAT THE UPS IS NOT OPERATING FROM THE BATTERY

Attention: even when the UPS is switched on, the load is disconnected in the event of a mains blackout.

If the input mains deviates from the established tolerances, the UPS automatically switches to Stdby mode and disconnects the load.

To force the UPS in manual bypass mode, press the ON and SEL key at the same time and hold down for at least 5 seconds or close the manual bypass isolator on the back of the UPS.

The code “C05” appears on the display.

To return to the normal operation mode press the ON and SEL keys again for at least 4 sec.

PROGRAMMABLE AUXILIARY SOCKET (EnergyShare)

The EnergyShare sockets are outlets that allow for the automatic disconnection of the load applied to them in certain operating conditions. The events that determine automatic disconnection of the EnergyShare sockets can be selected by the user through the **UPSTools** configuration software. For example, it is possible to select disconnection after a certain period of battery operation; or when the pre-alarm threshold for battery discharge has been reached, or when an overloading event occurs.

By default the Energyshare sockets are not configured and therefore function as other outlets.

The EnergyShare function is associated with an icon on the display whose meaning is explained in the paragraph entitled "**Display panel indications**"

Note: The maximum output current of EnergyShare sockets is 10A.

PARALLEL OPERATION MODE (OPTIONAL)

The **SENTINEL POWER GREEN** range makes it possible to connect up to 2 UPS units in parallel (each with its own battery), allowing redundancy in case of malfunction of one of the two UPS units or to double the power supplied by the UPS system.

This function is enabled through a designated kit which is available as an option.

The Parallel Kit contains 2 cards to insert in the designated slots (Parallel port, see section "PRESENTATION") and 2 parallel wires to connect to the card ports.

For further information on this function, refer to the Parallel Kit manual or visit www.riello-ups.com

SOFTWARE

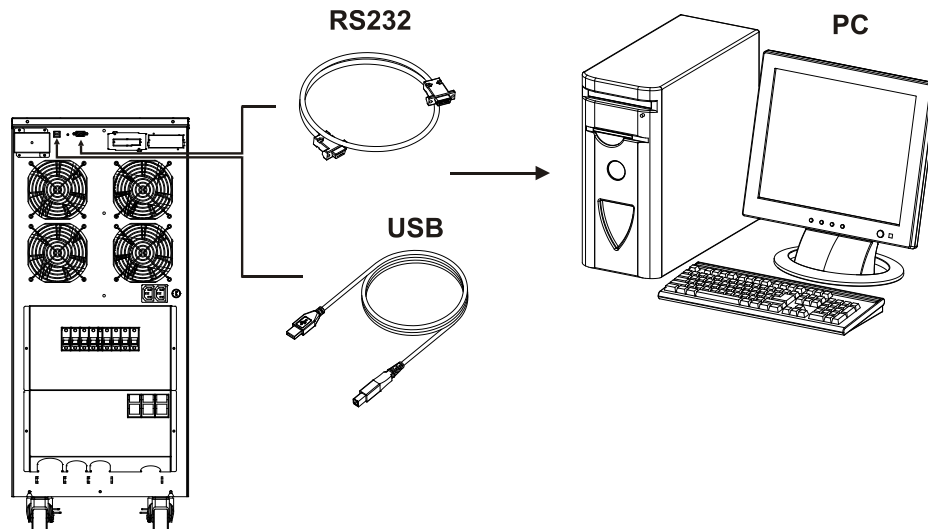

MONITORING AND CONTROL SOFTWARE

The **PowerShield³** software guarantees effective, intuitive UPS management, displaying all the most important information such as input voltage, applied load, battery capacity. It is also able to perform shutdown operations and send e-mails, text messages and network messages automatically when certain events, selected by the user, occur.

INSTALLATION OPERATIONS

- 1) Connect one of the UPS's communication ports to one of the PC's communication ports using the cable supplied.
- 2) Download the software from the web site **www.riello-ups.com** selecting the specific operating system.
- 3) Follow the installation program instructions.
- 4) For more detailed information please read the user manual which can be downloaded from **www.riello-ups.com**.

CONFIGURATION SOFTWARE

The **UPSTools** software allows the configuration and full display of the status of the UPS via USB or RS232. For a list of possible configurations available to the user, refer to the UPS Configuration paragraph.

INSTALLATION OPERATIONS

- 1) Connect one of the UPS's communication ports to one of the PC's communication ports using the cable supplied.
- 2) Follow the installation instructions shown within the software manual which can be located in the UPSTools directory or downloaded from the web site **www.riello-ups.com**.

CAUTION:

If the RS232 communication port is used, it is not possible to communicate with the USB port and vice versa.

It is advisable to use a cable which is shorter than 3 metres for communication with the UPS.

To obtain additional communication ports with different functions, independent from the standard USB and RS232 ports on the UPS, various accessories are available which can be inserted into the communication card slot.



To check whether new, more up-to-date software versions are available and for more information about the accessories available, consult the website: **www.riello-ups.com**.

UPS CONFIGURATION

The table below illustrates all the possible configurations available to the user in order to best adapt the UPS to individual requirements. It is possible to perform these operations using the Upstools software.

FUNCTION	DESCRIPTION	DEFAULT	POSSIBLE CONFIGURATIONS
Output frequency	Selects the nominal output frequency	Auto	<ul style="list-style-type: none"> • 50 Hz • 60 Hz • Auto: automatic learning of the input frequency
Output voltage	Selects the nominal output voltage	230V	220 - 240 in 1V steps
Operating mode	Selects one of the 4 different operating modes	ON LINE	<ul style="list-style-type: none"> • ON LINE • ECO • SMART ACTIVE • STAND-BY OFF (MODE 1)
Bypass operation	Selects the mode of use of the bypass line	Normal	<ul style="list-style-type: none"> • Normal • Disabled with input/output synchronisation • Disabled without input/output synchronisation
Power-off due to minimum charge	Automatic UPS power-off in battery operation mode if the charge is lower than 5%	Disabled	<ul style="list-style-type: none"> • Enabled • Disabled
Autonomy limit	Maximum battery operation time	Disabled	<ul style="list-style-type: none"> • Disabled (complete battery discharge) • (1 - 65000) sec. in 1 sec steps
Battery low warning	Estimated autonomy time remaining for the battery low warning	3 min.	(1 - 255) min. in 1 min steps
Battery test	Interval of time for the automatic battery test	40 hours	<ul style="list-style-type: none"> • Disabled • (1 - 1000) h in 1 hour steps
Maximum charge alarm threshold	Selects the user overcharge limit	Disabled	<ul style="list-style-type: none"> • Disabled • (0 - 103) % in 1% steps
Input frequency tolerance range	Selects the permitted range for the input frequency for switching to the bypass and for the synchronisation of the output	± 5%	(±3 - ±10) % in 1% steps

* For configurations of the $F_{out} = 50, 60\text{Hz}$ or if the sync is disabled with the input, the UPS downgrades the output power.

FUNCTION	DESCRIPTION	DEFAULT	POSSIBLE CONFIGURATIONS
EnergyShare	Select the auxiliary socket operating mode	Always connected	<ul style="list-style-type: none"> • Always connected • Disconnection after no. seconds of battery operation • Disconnection after no. seconds of the battery discharge pre-alarm signal • ... (see UPStools manual)
Bypass voltage thresholds	Selects the permitted voltage range for switching to the bypass	Low: 180V High: 264V	<ul style="list-style-type: none"> • Low: 180 - 200 in 1V steps • High: 250 - 264 in 1V steps
Bypass voltage threshold for ECO	Selects the permitted voltage range for operation in ECO mode	Low: 200V High: 253V	<ul style="list-style-type: none"> • Low: 180 - 220 in 1V steps • High: 240 - 264 in 1V steps
Intervention sensitivity for ECO	Selects the intervention sensitivity during operation in ECO mode	Normal	<ul style="list-style-type: none"> • Low • Normal • High
Power-on delay	Waiting time for automatic switching back on after mains power returns	5 sec.	<ul style="list-style-type: none"> • Disabled • (1 - 255) sec. in 1 sec steps
Remote power-on/off function	Selects the function associated with the RS232 connector.	Disabled	<ul style="list-style-type: none"> • Disabled • Remote ON • Remote OFF • Remote ON/OFF
Input configuration three-phase / Single-phase**	Selects the Input mains type	Three-phase	<ul style="list-style-type: none"> • Three-phase • Single-phase

** Only for versions SPH 8 - 10 - 10 ER - 15 - 20 - 20 ER. For further information about mains connections, please refer to the relative chapter "Connections"

COMMUNICATION PORTS

On the back of the UPS (see *UPS Views*), the following communication ports are present:

- RS232 connector
- USB connector
- Expansion slot for additional communication cards

RS232 CONNECTOR

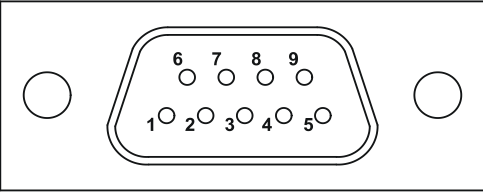
RS232 CONNECTOR		
		
PIN #	SIGNAL	NOTES
1	Programmable output *: [default: UPS in lock]	(*) Opto-isolated contact max. +30Vdc / 35mA. These contacts can be associated with other events using the software provided (**) Opto-isolated command +5 - 15Vdc. These contacts can be associated with other events using the software provided For further information about interfacing with the UPS, refer to the manual provided
2	TXD	
3	RXD	
4	Programmable input **: [default: disabled]	
5	GND	
6	Power supply DC ($I_{max} = 20mA$)	
7	Programmable input **: [default: disabled]	
8	Programmable output *: [default: low battery pre-alarm]	
9	Programmable output *: [default: battery operation]	

COMMUNICATION SLOT

The UPS is equipped with an expansion slot for optional communication cards (see figure on right) which allows the device to communicate using the main communication standards.

Some examples:

- Second RS232 and USB port
- Serial duplicator
- Ethernet network card with TCP/IP, HTTP and SNMP protocols
- JBUS / MODBUS protocol converter card
- PROFIBUS protocol converter card
- Card with relay isolated contacts

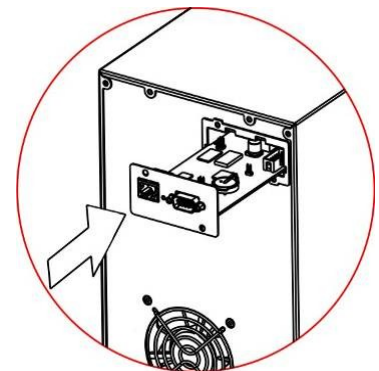

To check whether further accessories are available, consult the website: www.riello-ups.com

TROUBLESHOOTING

Irregular UPS operation is most likely not an indication of a fault but due to simple problems or distraction. It is therefore advisable to consult the table below carefully as it summarises information which is useful for solving the most common problems.

PROBLEM	POSSIBLE CAUSE	SOLUTION
THE DISPLAY DOES NOT LIGHT UP	INPUT SWITCH OPEN	Close the input switch located on the back of the UPS..
	MAIN CONNECTION CABLE MISSING	Check that the power cable is connected correctly.
	NO MAINS VOLTAGE (BLACKOUT)	Check that the power reaches the socket where the UPS is connected (try it with a table lamp, for example).
	UPSTREAM THERMAL PROTECTION TRIP	Reset the thermal protection. CAUTION: Check that there is no output overload to the UPS.
THE DISPLAY IS ON BUT THE LOAD IS NOT POWERED	THE UPS IS IN STAND-BY MODE	Press the "ON" button on the front panel to power the loads.
	THE STAND-BY OFF MODE IS SELECTED	It is necessary to change mode. The STAND-BY OFF (emergency power supply) mode, in fact, only powers the loads in the event of a blackout.
	NO CONNECTION TO THE LOAD	Check the connection to the load.
THE UPS IS OPERATING FROM THE BATTERY DESPITE THE PRESENCE OF MAINS VOLTAGE	THE INPUT VOLTAGE IS OUTSIDE THE PERMITTED TOLERANCE RANGE FOR MAINS OPERATION	Problem with the mains. Wait until the input mains voltage returns within the tolerance range. The UPS will automatically return to mains operation.
	UPSTREAM THERMAL PROTECTION TRIP	Reset the thermal protection. CAUTION: Check that there is no output overload to the UPS.
THE DISPLAY SHOWS THE FOLLOW CODE F10	INPUT FUSE FAULTY	Switch off and disconnect the UPS from the power supply and contact the support centre.

PROBLEM	POSSIBLE CAUSE	SOLUTION
THE BUZZER SOUNDS CONTINUOUSLY AND THE DISPLAY SHOWS ONE OF THE FOLLOWING CODES: A54, F50, F51, F52, F53, L50, L51, L52, L53	THE LOAD APPLIED TO THE UPS IS TOO HIGH	Reduce the load to within the threshold of 100% (or user threshold in the case of code A54). If the display shows a lock: remove the load and switch the UPS off and back on again.
THE DISPLAY SHOWS THE FOLLOW CODE: A62	BATTERIES MISSING OR BATTERY BOX MISSING OR NOT CONNECTED	On the versions with an additional battery charger in place of the batteries, check that the Battery Box is inserted and connected to the UPS correctly.
THE BUZZER SOUNDS CONTINUOUSLY AND THE DISPLAY SHOWS ONE OF THE FOLLOWING CODES: F20, F21, F22, F40, F43, F96	THE UPS IS MALFUNCTIONING; IT WILL PROBABLY LOCK SOON	If possible, disconnect the power to the load, switch the UPS off and back on again; if the problem occurs again, call the support centre.
THE BUZZER SOUNDS CONTINUOUSLY AND THE DISPLAY SHOWS ONE OF THE FOLLOWING CODES: F04, L04	THE TEMPERATURE OF THE DISSIPATORS INSIDE THE UPS IS TOO HIGH	Check that the temperature of the environment in which the UPS is located does not exceed 40°C.
THE BUZZER SOUNDS CONTINUOUSLY AND THE DISPLAY SHOWS ONE OF THE FOLLOWING CODES: F53, L53	THERE IS A FAULT ON ONE OR MORE OF THE UTILITIES POWERED BY THE UPS	Disconnect all the utilities, switch the UPS off and back on again, reconnect the utilities one at a time to identify which one is faulty.
THE BUZZER SOUNDS CONTINUOUSLY AND THE DISPLAY SHOWS ONE OF THE FOLLOWING CODES: F31, F33, F60, L20, L21, L22, L23, L24, L40, L41, L42, L43, L96	THE UPS IS MALFUNCTIONING	If possible, disconnect the power to the load, switch the UPS off and back on again; if the problem occurs again, call the support centre.
THE DISPLAY SHOWS ONE OF THE FOLLOWING CODES: C01, C02, C03, C05, C05	A REMOTE COMMAND IS ACTIVE	If unwanted, check the status of the command inputs on any optional contact card.
THE DISPLAY SHOWS C02	THE MANUAL BYPASS FUNCTION IS ACTIVE	To take the UPS out of the manual bypass function, press the ON and SEL keys at the same time and hold them down for at least 4 seconds or open the manual bypass isolator on the back of the UPS.



ATTENTION:

The UPS in case of a permanent failure will be not able to supply the load. To ensure total protection of your equipment we suggest you install an ATS device (Automatic Transfer Switch) or an external automatic by-pass.

For more information visit www.riello-ups.com

ALARM CODES

Using a sophisticated self-diagnosis system, the UPS is able to check its own status and any anomalies and/or faults which may occur during normal operation and display them on the display panel. If there is a problem, the UPS signals the event by showing the code and the type of active alarm on the display (FAULT and/or LOCK).

FAULT

FAULT alerts can be divided into three categories:

- **Anomalies:** these are “minor” problems which do not cause the lock of the UPS but reduce performance or prevent certain functions from being used.

CODE	DESCRIPTION
A04	Fans blocked
A12	Cable connection error
A14	No neutral (three-phase input)
A15	Unbalanced input voltages (three-phase input)
A30	E.P.O control active
A50	Overload: load > 105%
A54	Load percentage greater than the user threshold set
A62	Batteries missing or Battery Box missing or not connected
A64	Low battery
A90	Status of different UPS batteries (parallel UPS configuration)
A91	Status of different UPS inputs (parallel UPS configuration)
A93	Different UPS operation modes (parallel UPS configuration)
A94	Different UPS sizes (parallel UPS configuration)
A95	UPS operation mode not set as Online or CVCF (parallel UPS configuration)

- **Alarms:** these are more critical problems than anomalies because, if they persist, they could cause the UPS to lock in a very short time.

CODE	DESCRIPTION
F04	Dissipator overtemperature
F07	Ambient overtemperature
F10	Input fuse faulty
F20	Capacitor bank undervoltage
F21	Capacitor bank overvoltage
F22	Unbalanced capacitor bank
F31	Output relay stuck (closed)
F32	Incorrect PIN setting
F33	Back feed alarm active
F40	Inverter overvoltage
F41	Short circuit
F43	Inverter undervoltage
F50	Overload: load > 105%
F51	Overload: load > 110%
F52	Overload: load > 130%
F53	Overload: load > 150%
F60	Battery overvoltage
F65	Battery charge fault
F92	Different UPS Bypass Status (present/ not present) (parallel UPS configuration)
F96	Negative output power
F97	Male parallel cable not connected
F98	Female parallel cable not connected

- **Active commands:** Indicates the presence of an active remote command.

CODE	DESCRIPTION
C01	Remote control 1 (Switch On/Off)
C02	Remote control 2 (load on bypass or manual bypass command)
C03	Remote control 3 (Switch On/Off)
C04	Battery test in progress
C05	Remote control 4 (manual bypass)

LOCK

LOCK alerts are normally preceded by an alarm signal and their scale leads to the power-off of the inverter and the load being powered by the bypass line (this procedure is excluded for locks due to serious, persistent overloads and short circuits).

CODE	DESCRIPTION
L04	Dissipator over temperature
L07	Ambient overtemperature
L20	Capacitor bank undervoltage
L21	Capacitor bank overvoltage
L22	Unbalanced capacitor bank
L23	Capacitor bank short circuit
L24	Failed capacitor bank soft start
L40	Inverter overvoltage
L41	Short circuit
L42	Failed inverter soft start
L43	Inverter undervoltage
L50	Overload: load > 105%
L51	Overload: load > 110%
L52	Overload: load > 130%
L53	Overload: load > 150%
L96	Negative output power
L97	Male parallel cable not connected
L98	Female parallel cable not connected

TECHNICAL DATA

UPS MODELS	SPM 6	SPH 8	SPH 10 SPH 10 ER	SPH 15	SPH 20 SPH 20 ER
------------	-------	-------	---------------------	--------	---------------------

INPUT

Nominal voltage [Vac]	220 - 230 - 240	220 - 230 – 240 / 380 – 400 - 415			
Maximum operating voltage [Vac]	300	300 / 520			
Nominal frequency [Hz]	50 - 60				
Nominal current ⁽¹⁾ [A]	27	36 / 13	45 / 15 (46 / 19 ER)	67 / 23	89 / 30 (90 / 30,5 ER)

BATTERY

Recharge time (standard versions) [h]	< 4h for 80% of the load				
Expandability and nominal voltage of the Battery Box	180Vdc	240Vdc	240Vdc	240 + 240Vdc	240 + 240Vdc
Charging current (for ER versions only)	Not applicable	8A	Not applicable	8A	8A

OUTPUT

Nominal voltage ⁽⁴⁾ [Vac]	Selectable: 220 / 230 / 240	Selectable: 220 / 230 / 240 – 380 / 400 / 415			
Frequency ⁽²⁾ [Hz]	Selectable: 50, 60 or auto sensing				
Nominal power [VA]	6000	8000	10000	15000	20000
Nominal power [W]	5400	6400	9000	13500	18000
Overload: 100% < load < 110%	Bypass line available:		activates the bypass after 2 seconds locks after 120 seconds		
	Bypass line not available:		locks after 60 seconds		
Overload: 110% < load < 150%	Bypass line available:		activates the bypass after 2 second locks after 4 seconds		
	Bypass line not available:		locks after 4 seconds		
Overload load > 150%	Bypass line available:		activates the bypass instantly locks after 1 second		
	Bypass line not available:		locks after 0.5 seconds		

OTHER

Leakage current to earth [mA]	< 1,5mA			< 2mA	
Ambient temperature ⁽³⁾ [°C]	0 – 40				
Humidity	< 90% without condensation				
Protection devices	excessively low batteries - overcurrent - short circuit - overvoltage - undervoltage - circuit breaker				
Dimensions W x D x H [mm]	262 x 557 x 708				350 x 653 x 818
Weight [kg]	62,4	77,7	84,1 (28,1 ER)	146	157 (48 ER)
Weight (for ER versions only) [kg]	Not applicable	Not applicable	18	Not applicable	25
Parallel	Max 2 units in parallel configuration with optional kit				

For more details please consult the web site

- (1) at nominal load, nominal voltage of 230 Vac, battery charging
- (2) If the mains frequency is within $\pm 5\%$ of the selected value, the UPS is synchronised with the mains. If the frequency is out of the tolerance range or operating from the battery, the frequency is the one selected $\pm 0.1\%$
- (3) 20 - 25 °C for longer battery life
- (4) To keep the output voltage within the indicated range of precision, recalibration may be necessary after a long period of operation.

BATTERY BOX		180VDC 7Ah/ 180VDC 9Ah	180VDC 7+7Ah/ 180VDC 9+9Ah	240VDC 7Ah/ 240VDC 9Ah	240VDC 7+7Ah/ 240VDC 9+9Ah
Nominal battery voltage	[Vdc]	180Vdc		240Vdc	
Dimensions W x D x H	[mm]	262 x 557 x 708		262 x 557 x 708	
Weight	[kg]	63 / 64,5	99 / 102	75 / 77	123 / 127



www.riello-ups.com

RPS SpA – *Riello Power Solutions*
Viale Europa, 7
37045 Legnago (VR)
Italy

0MNSPH6K0RU5LUA