

DATALOGIC™

Smart Vision Sensor

DataVS1



*The easy way
to machine vision*

INSTRUCTION MANUAL

DATALOGIC AUTOMATION

Via Lavino 265 - 40050 Monte S.Pietro - Bologna – Italy

Tel: +39 051 6765611- Fax: +39 051 6759324

www.automation.datalogic.com e-mail: info.automation.it@datalogic.com

DATALOGIC AUTOMATION reserves the right to make modifications and improvements without prior notification.

Datalogic and the Datalogic logo are registered trademarks of Datalogic S.p.A. in many countries, including the U.S.A. and the E.U.

826003842 rev.B © Copyright Datalogic 2009-2010



Datalogic Automation S.r.l.
Via S. Vitalino 13
40012 Lippo di Calderara di Reno
Bologna – Italy
www.automation.datalogic.com

Operation Office:
Via Lavino 265
40050 Monte San Pietro
Bologna - Italy

declares that the

DATAVS1 ; SMART CAMERA SENSOR

and all its models

are in conformity with the requirements of the European Council Directives listed below:

2004 / 108 / EC EMC Directive

This Declaration is based upon compliance of the products to the following standards:









- EN 60947-5-2, Ed.3 DECEMBER 2007:** *LOW-VOLTAGE SWITCHGEAR AND CONTROLGEAR.
PART 5: CONTROL CIRCUIT DEVICES AND SWITCHING.
SECTION 2: PROXIMITY SWITCHES
PRODUCT STANDARD IS IDENTICAL TO: IEC 60947-5-2, OCTOBER 2007*
- EN 61000-6-2, SEPTEMBER 2005:** *ELECTROMAGNETIC COMPATIBILITY (EMC)
PART 6-2: GENERIC STANDARDS - IMMUNITY FOR INDUSTRIAL ENVIRONMENTS*
- EN 55011 (CLASS A ISM), MARCH 2007:** *INDUSTRIAL, SCIENTIFIC AND MEDICAL (ISM) RADIO-FREQUENCY EQUIPMENT -
ELECTROMAGNETIC DISTURBANCE CHARACTERISTICS - LIMITS AND METHODS
OF MEASUREMENT*

Monte San Pietro, February 22th, 2010

Paolo Morselli
Quality Manager



INDEX

1. GENERAL INFORMATION	1
1.1. Conventions used in the manual	1
1.2. General description	1
1.3. Available models	1
2. ELECTRICAL CONNECTIONS	2
3. OPERATING DISTANCES	3
4. VISION SENSOR AND CONFIGURATOR: GENERAL CHARACTERISTICS	4
4.1. DataVS1 Vision Sensor	4
4.2. Installing the sensor	5
4.3. VSC Configurator	7
4.4. Installing the configurator	8
4.5. Hardware connections	10
4.6. Safety recommendations	11
5. INSPECTION CONFIGURATION USING VSC	12
5.1. Introduction	12
5.2. VSC user interface	12
5.3. General considerations	13
5.4. Step 1 - Configuration of the camera settings and choice of the inspection tool	13
5.5. Step 2 - Configuration of the selected inspection tool	19
5.6. Step 3 - Inspection tool function check	20
5.7. Step 4 - Output definitions and saving the inspection settings to the sensor	23
6. VSC CONFIGURATOR: ADVANCED FUNCTIONS	26
6.1. Output	26
6.2. Trigger Mode	28
6.3. Load/Save	30
6.4. Fail Inspector	32
6.5. DataVS1 Ver.	33
6.6. Input Config	34
6.6.1. <i>Standard Protocol</i>	34
<i>Protocol description</i>	34
<i>Protocol selection</i>	35
<i>Inspection switch timing</i>	35
6.6.2. <i>Expert Protocol</i>	36
<i>Protocol Description</i>	36
<i>Protocol Selection</i>	38
6.6.3. <i>Digital Teach In</i>	38
6.7. Password	38
7. CONTROLS	41
7.1. Remarks	41
7.2. Brightness	42
7.3. Contrast	45
7.4. Position	49
7.5. Width	52
7.6. Edge count	56
7.7. Pattern Match	59
7.8. OCV	63
7.9. Pattern Count	67
8. TEACH BUTTON	71
9. CHECKS AND PERIODIC MAINTENANCE	72
10. WARRANTY	72
11. TECHNICAL DATA	73
12. OVERALL DIMENSIONS	74
13. ACCESSORIES	75
14. TUTORIAL	77
14.1.  Digital image	77
14.2.  Machine vision	78
14.3.  General comments on lighting	78
14.4.  Lighting options	79
14.5.  Binarization	80
14.6.  Edge / Edge Detection	81
14.7.  Inspection times	82
14.8.  Pattern Match	82
14.9.  Exposure	83
15. GLOSSARY	84

1. GENERAL INFORMATION

1.1. Conventions used in the manual

This manual has been developed to provide clear and precise instructions on how to use the DataVS1 system.

For more detailed information on the algorithms and techniques referenced in the manual, please find symbols such as (📖) present throughout the text which refer to Chap.14 - TUTORIAL.

Boxed text provides definitions to ensure better understanding of the specific topic.

Examples are printed in italics.



This refers to particularly interesting information.

For other significant terms, please refer to the GLOSSARY in Chapter 15.

1.2. General description



DataVS1 by Datalogic is a vision sensor (machine vision 📖) which is easy to use and has advanced inspection functions which allow it to be implemented in many fields (quality control on production lines or automatic material handling are just a few examples).

It basically works by comparing the digital image (📖) acquired in a precise moment ("target image") and a previously acquired reference image ("reference image").



Once the DataVS1 has been configured (using the VSC), it can function in "stand-alone" mode, that is completely automatic.

1.3. Available models

Item Number	Model	Description				
		Sensor	Lens	VSC configurator	Connection cable	Power supply cable
959941000	DataVS1-08-DC-K	✓	8mm	✓	✓	✓
959941010	DataVS1-06-DC-S	✓	6mm			
959941020	DataVS1-08-DC-S	✓	8mm			
959941030	DataVS1-12-DC-S	✓	12mm			
959941050	DataVS1-16-DC-S	✓	16mm			
959941040	DataVS1-VSC			✓		

2. ELECTRICAL CONNECTIONS

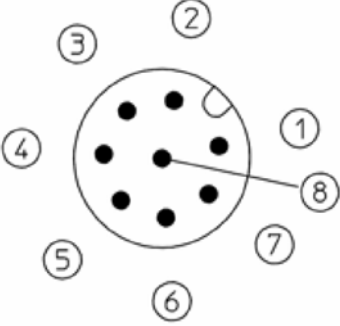
DataVS1 sensor

	
<p>M12 8 poles (VSC connection)</p> <p>pin 1: ethernet TX+ pin 2: ethernet RX+ pin 3: ethernet RX- pin 4: not used pin 5: 24 Vdc pin 6: not used pin 7: ethernet TX- pin 8: GROUND</p>	<p>M12 8 poles (power and I/O)</p> <p>pin 1: white : digital input 1 pin 2: brown : 24 Vdc pin 3: green : STROBE for external illuminator pin 4: yellow : output 1 pin 5: grey : output 2 pin 6: pink : output 3 pin 7: blue : GROUND pin 8: red : external trigger</p>

VSC Configurator

M12 8-pole Ethernet: (DataVS1 connection)

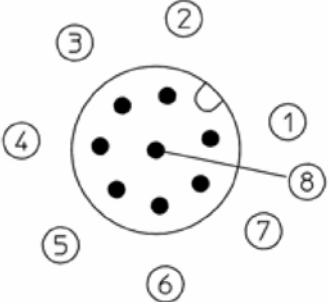
<p>pin 1: ethernet TX+ pin 2: ethernet RX+ pin 3: ethernet RX- pin 4: not used pin 5: 24 Vdc pin 6: not used pin 7: ethernet TX- pin 8: GROUND</p>	
--	---

3. OPERATING DISTANCES

	Field range size (L x H) in mm			
Operating distance (mm)	DataVS1-16-DC-S	DataVS1-12-DC-S	DataVS1-08-DC-x	DataVS1-06-DC-S
50	-	17 x 12	25x20	42x30
80	-	25 x 20	40x30	60x41
110	-	33 x 25	55x40	80x55
140	31 x 24	45 x 35	70x50	98x69
170	39 x 29	53 x 38	85x60	118x83
200	46 x 34	60 x 50	100x70	138x92
300	70 x 53	90 x 65	145x103	201x140
400	94 x 71	121 x 82	186x132	265x189
500	118 x 89	150 x 110	236x167	330x232
600	143 x 107	185 x 130	282x232	385x270

4. VISION SENSOR AND CONFIGURATOR: GENERAL CHARACTERISTICS

4.1. DataVS1 Vision Sensor



DataVS1 is an ultra compact vision sensor which integrates all the photoelectric elements required to perform reliable control activities based on the comparison of two images. Once configured, the sensor can therefore function in a "stand-alone" mode and automatically acquires an image, controls it and then activates the outputs according to the result of the inspection.

The images seen below, highlight the main characteristics of the sensor.

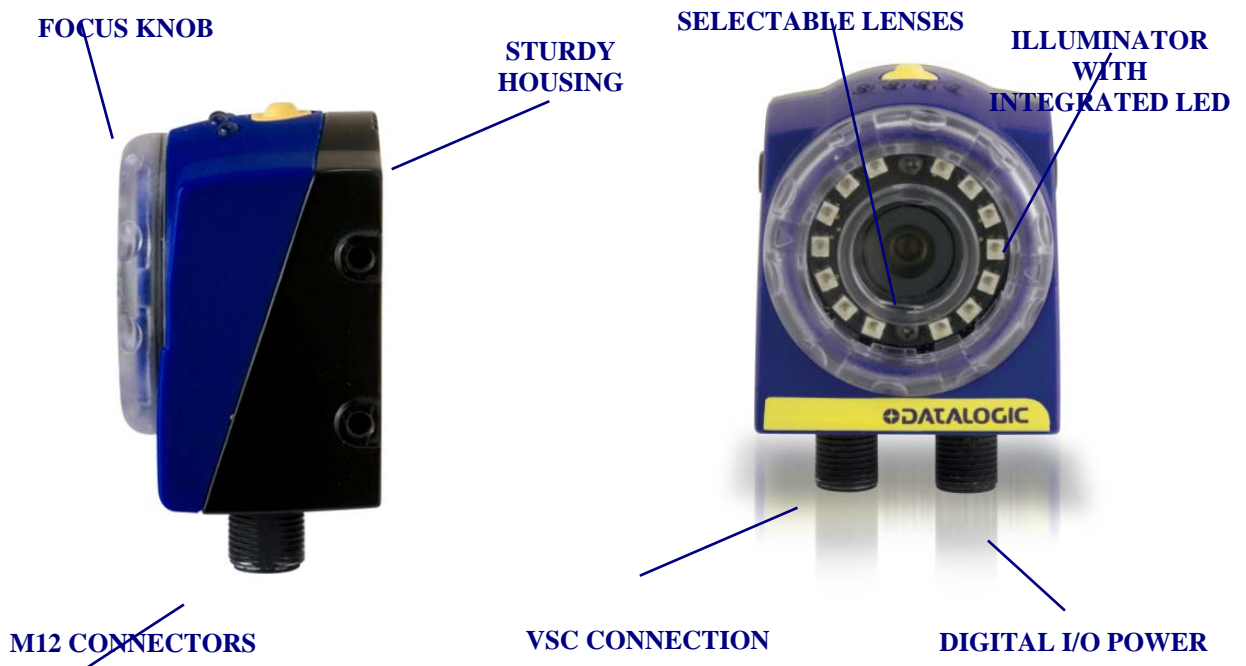

The user interface is also inserted in the upper part of the sensor, consisting in 4 LED indicators and a Teach-in button. More precisely:

- **LED 1:** Power (green)

- **LED 2:** Digital output 2 (orange)
- **LED 3:** Digital output 1 (orange)
- **LED 4:** Connection to VSC configurator (green)

The Teach button functions will be explained in more detail successively (Chapter 8).



4.2. Installing the sensor

The correct position of the vision sensor is essential in order to function properly. There are various aspects to be considered during installation, which have to be evaluated. The following chart summarises the main aspects to consider regarding positioning.

Aspect	Position suggestions
Field of view	The dimension of the range acquired by the sensor varies according to the distance from the target object to be inspected (see Chapt. 3). For this reason, the sensor should be placed at a distance which allows it to focus and observe the entire target object to be inspected.
Resolution	<p>On the contrary to the field range dimension concept, the resolution of the image acquired by the sensor decreases as the distance from the target object increases. This is because the sensor acquires an image with 640x480 pixels. Increasing the focus range, decreases the number of pixels per unit.</p> <p><i>The image to the right shows better resolution compared to the one on the left. The 640 pixels along the horizontal axis are in fact entirely "dedicated" to writing. In the first image, however, only half of them define the logo.</i></p>
Lighting	Environmental lighting generally creates a source of disturbance. It can in fact vary, (e.g. the natural light that shines through a window can vary in intensity throughout the day) and can therefore compromise the results of repeated control procedures. It is therefore

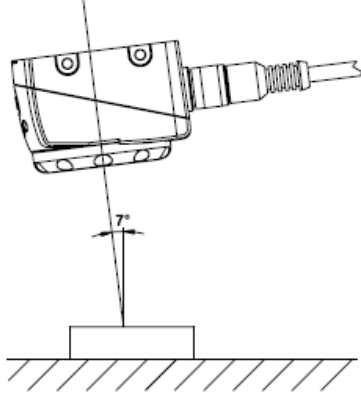
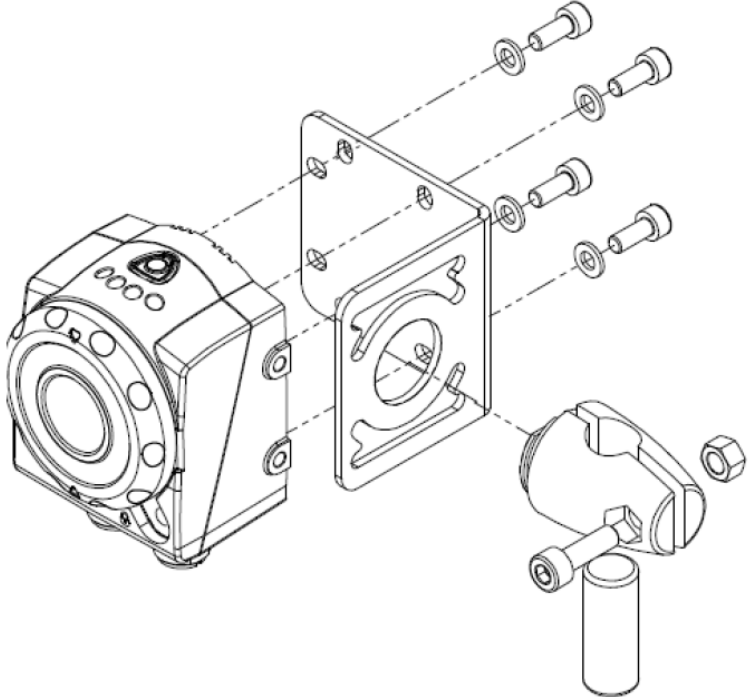
	<p>highly recommended to minimise the influence of environmental lighting in the sensor focus range. Please refer to the tutorial () for further information on industrial lighting.</p>
Angles	<p>In order to avoid reflections on the target object, it is recommended, where possible, to angle the sensor by a few degrees compared to the vertical axis of the target object.</p> 
Fixing the sensor	<p>The DataVS1 must be fixed firmly to a stable support, which is not subject to vibrations and protected from contact with any liquids. The catalogue stocks a range of brackets which are specifically designed to support the sensor. For instance, the diagram below shows a sensor fitted with an assembly kit (95A901380).</p> 



The VSC configurator is an excellent instrument used to find the best position for the sensor. It allows the installer to view the field range of the DataVS1 in real time, and adjust its position accordingly. For this reason, it is highly recommended in difficult installation situations, to connect the sensor and the configurator to the power supply (see paragraph 4.5) and then, according to what is viewed on the monitor, choose the desired position.

4.3. VSC Configurator



The VSC configurator allows the installer to quickly and easily adjust the sensor settings. Once the DataVS1 has been connected, the installer can instantly access all the sensor functions, from the creation of a new inspection, to modification of parameters, from the viewing of the results and statistics to the management of digital outputs. Once the DataVS1 settings have been completed, the configurator can be used to view the results of the current target inspection, or it can be disconnected so that the sensor will continue to function in stand-alone mode.

The image seen below, highlights the main characteristics of the VSC (see also paragraph 5.1).

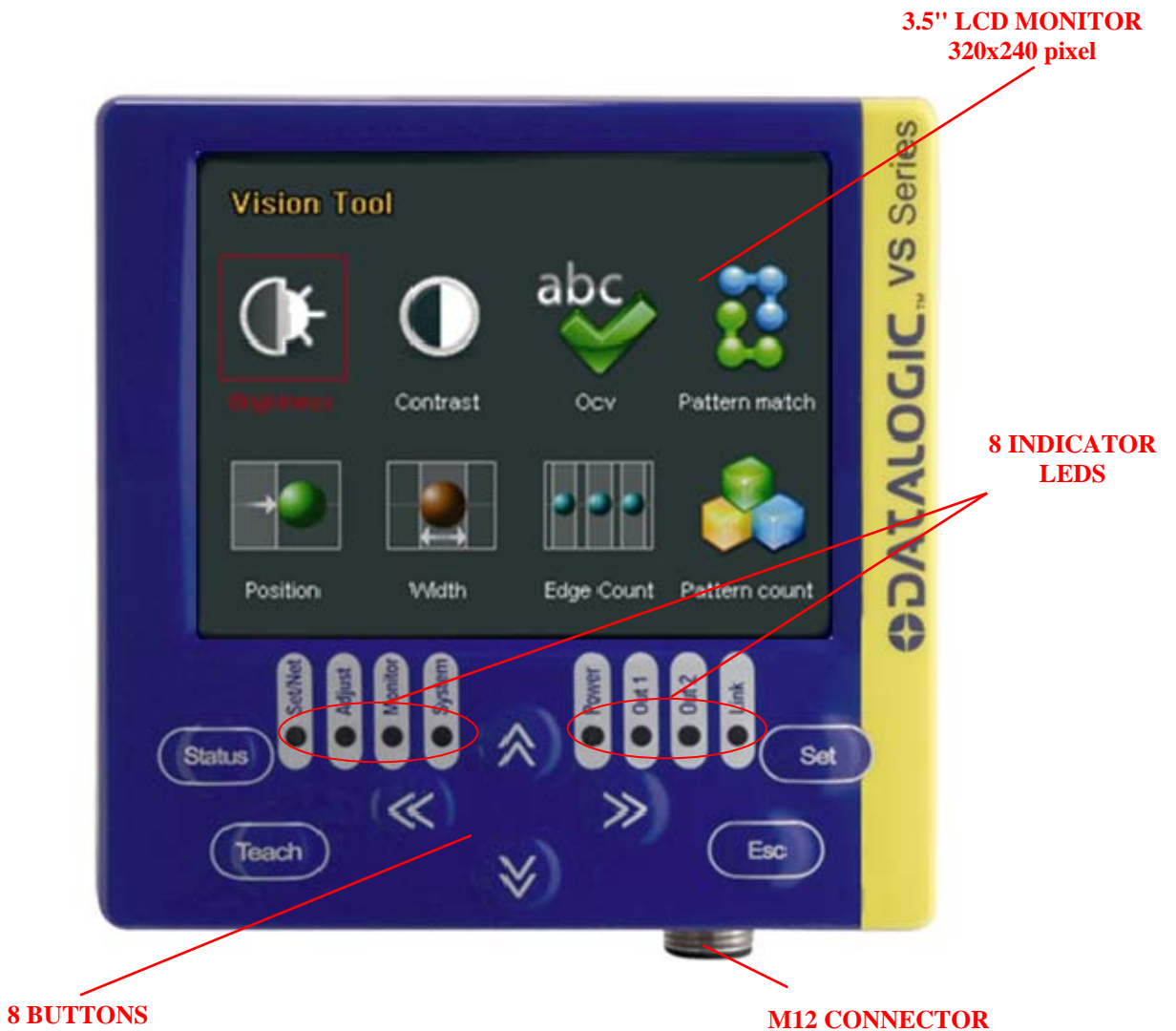

4.4. Installing the configurator

There is a slot on the back of the VSC configurator which allows the user to connect the device to a DIN Rail. During installation it is therefore sufficient to wedge the configurator on the rail and block it in place using the two white locking clips.

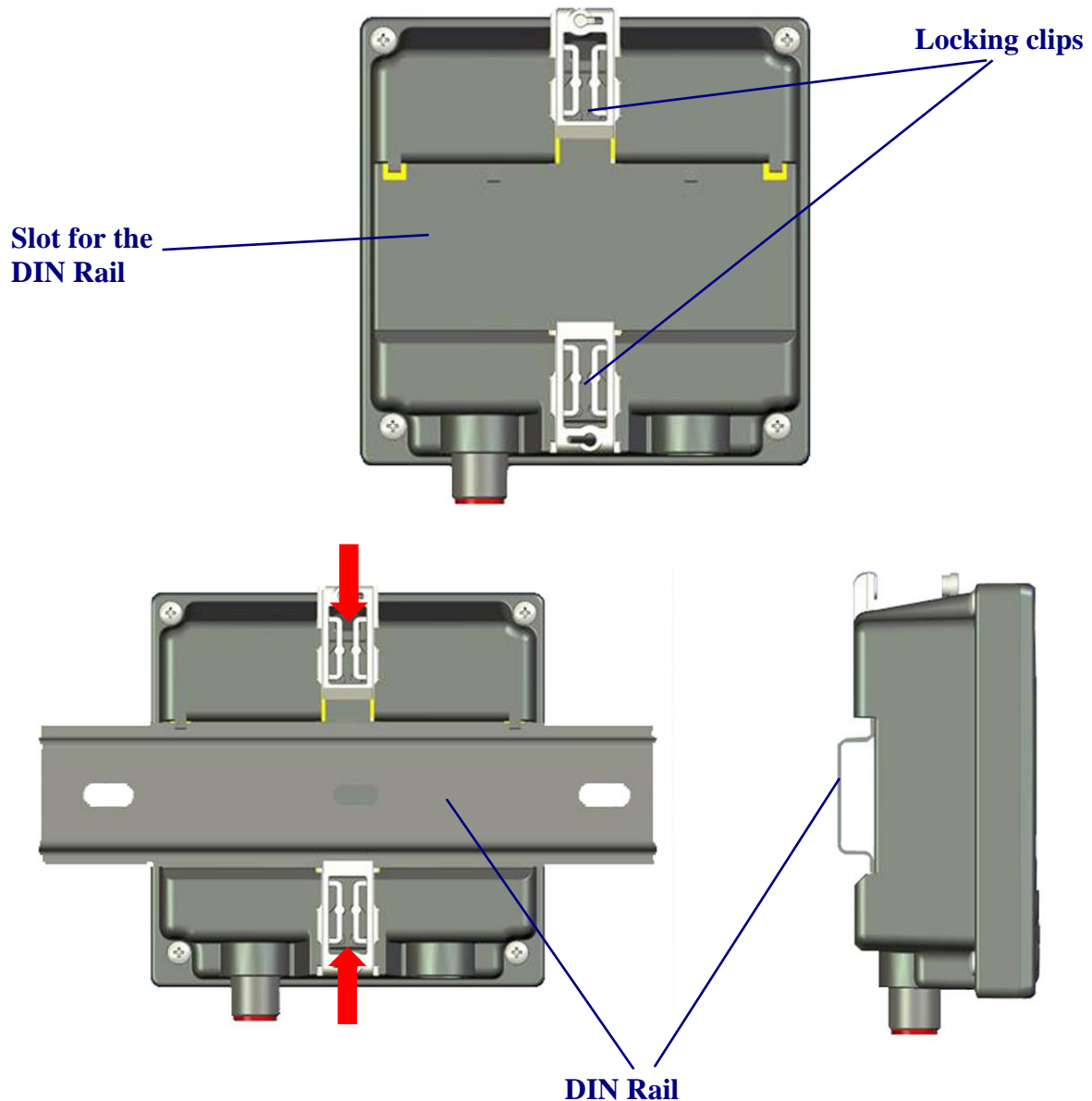

It is also possible to install the VSC configurator on a panel. All the accessories for this kind of installation are included in the package.

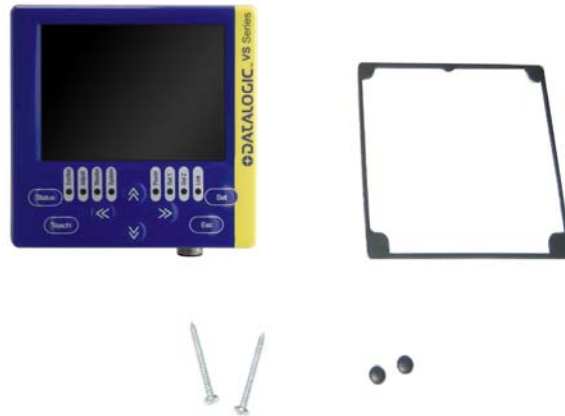

First, place the rubber seal around the body of the configurator paying attention to the shape of it.

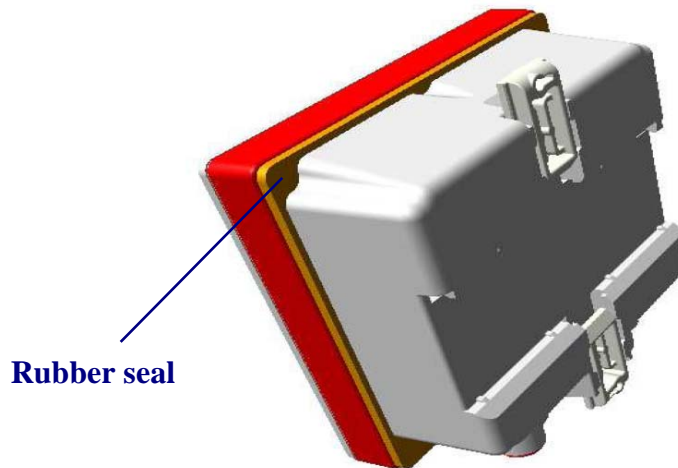

Then fix the configurator to the panel by using the two locking screws and the rubber caps.

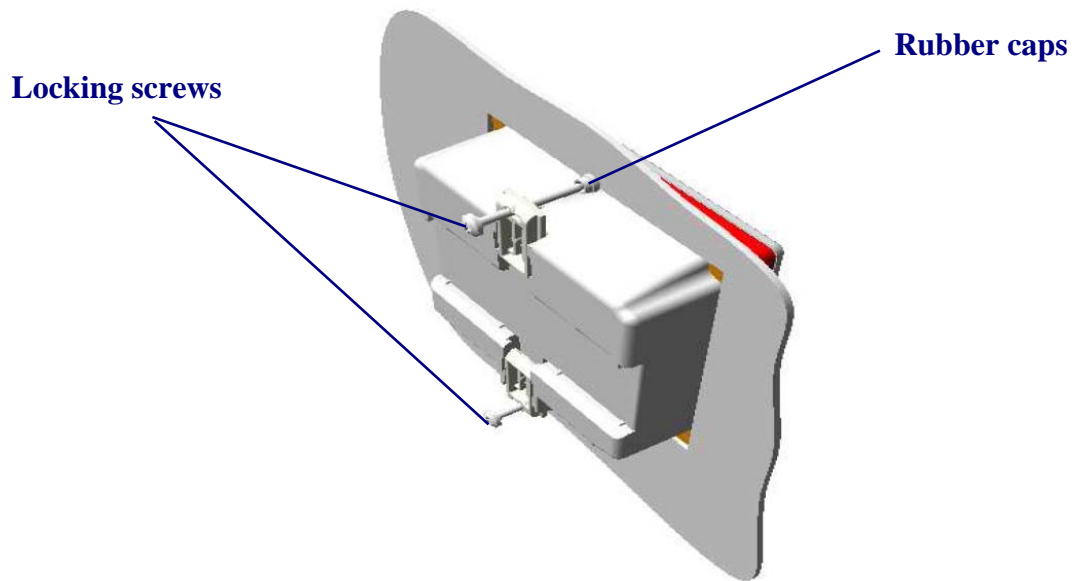

4.5. Hardware connections

Connect the power and I/O cable (CS-A1-06-B-xx) inserting it into the connector identified by the (PWR-I/O) icon.



Connect DataVS1 to the VSC using the relative connection cable (SVS-CV-VSC-xx).



Warning

- Insert the cable into the correct connector following the key indications inside the body.
- After inserting the cable, turn the ring nut clockwise to ensure connection is completed
- Never force the cable inside the connectors.
- Make sure that every cable is connected to the right connector
- Before disconnecting the cable, turn the ring nut clockwise as far as possible

4.6. Safety recommendations

- Read the instruction manual carefully before installing the sensor and configurator.
- Make sure that the product is suitable for the system that you intend to set up.
- Connect the cables to the devices with the poles in the right direction.
- Power up the devices following the instructions contained in the Manual.
- Protect all devices against dust, dirt and humidity.
- Never spill liquids on the devices
- It is strictly prohibited to use DataVS1 on systems where the safety of persons and/or things are guaranteed by the correct functioning of the device.
- Always RESPECT all safety rules and regulations.
- Never use the devices in environments where there is a risk of explosion.
- Do not subject the devices to strong and continuous vibration.

5. INSPECTION CONFIGURATION USING VSC

5.1. Introduction

The configuration of the DataVS1 vision sensor can only be performed using the VSC unit.

This chapter provides the basic procedures to follow in order to programme the sensor settings correctly. Chapters 6 and 7 provide further details on the various configuration options and a more complete panorama on the DataVS1 functions.

To simplify the instructions described in this manual the pressing of the buttons on the configurator user interface will be indicated using the following diagram:



Example: Press the "Status" button

5.2. VSC user interface

The chart below provides a general overview of the user interface on the VSC configurator. Please note however that the functions of the buttons vary according to the operating mode selected by the user. Please consult the next chapters for further details on how the system reacts to the pressing of the buttons.

BUTTON	
ID button	Main functions
Status	Go to the next configuration status
Teach	Saving of settings Acquire a new reference image
Set	Confirms selected option Confirms setting value Changes monitor mode
Esc	Exit without saving Back to previous screen Back to the previous configuration step
Arrows	Changes selected option Movement/resizing of the ROI Changes the parameters

LED		
LED ID	Colour	Meaning
Power	Green	VSC Configurator correctly powered up
Out 1	Orange	Digital output 1 active
OUT 2	Orange	Digital output 2 active
Link	Green	VSC Configurator correctly connected to the sensor
Set/Net	Green	Current status: Setup
Adjust	Green	Current status: Adjust
Monitor	Green	Current status: Monitor
System	Green	Current status: System

5.3. General considerations

A correct configuration based on the acquisition of a good-quality reference image is necessary to ensure accurate inspection.

The term inspection means the set of operations the sensor performs to check the features of an object for compliance with certain specifications.

Each individual object is compared to the reference image to determine whether it meets the specified requirements.

For this reason, the reference image must have neat contours and clearly visible features.

Here are a few tips to facilitate correct configuration:

- Decide exactly which feature of the product must be monitored
- Make sure that the lighting is correct and, above all, as consistent as possible: correct image acquisition is achieved by minimising the influence of the environmental light in the area being monitored (📖)
- Make sure there is good contrast between the object being monitored and the background
- Carefully choose the tools (or "controls") to be used for the elaboration in order to achieve the best results as quickly and easily as possible
- Carefully adjust the control parameters
- It may be useful to perform preliminary tests to detect which cases are the most difficult to define and adjust the tolerances accordingly
- Compare the results to detect any inconsistent results

5.4. Step 1 - Configuration of the camera settings and choice of the inspection tool

When the VSC configurator is powered up, the welcome screen will be displayed on the monitor.



After a few seconds from start-up, the system will automatically move into Monitor Mode and display the focus range of the vision sensor, with the current inspection in the region of interest (ROI).



NOTE: if no inspection is saved on the DataVS1 sensor the system will display the "Vision Tool" menu from where the user can select the control to be used. For further details, please refer to the paragraph marked with the ► symbol on Page 14. The camera settings explained in this section can be performed at any moment in time.

To configure the inspection option it is necessary to start from Setup Mode. Press the **STATUS** button twice to enter Start-up Mode. The green Set/Net LED will light up and the monitor will display the following image.



As you can see in the image, the VSC screen is split into two main areas: the field range of the camera and the settings and options available.

The image acquired by the sensor is displayed in the first area. If the field is out of focus, it is possible to adjust the focus ring on the sensor (see par.4.1). The configuration options are indicated on the right hand side of the screen. The user can use the two arrow buttons to scroll the options.

The first step when creating a new inspection rule is to enter the sensor mode settings. To modify these settings, use the arrows to reach the **CAMERA** icon and then press **SET**.



The settings that the user can modify will appear on the screen. To move from one setting to another, simply press the **ARROW UP/ARROW DOWN** buttons.

Parameter	Description	Change
Internal illuminator	Select or deselect the option to enable/disable the illuminator fitted on the sensor.	Press the SET button to enable/disable the option.
External illuminator	Select or deselect the option to enable/disable the strobe signal that the sensor can use to pilot the external illuminator.	Press the SET button to enable/disable the option.
Exposure time	The exposure time identifies the period that the lens remains open and allows light to reach the CMOS mounted on the sensor. Therefore, the longer the exposure time, the brighter the image will be. On the other hand, increasing the exposure times increases the risk of acquiring blurred images where the detail being monitored moves at a certain speed. If the images of objects that move quickly are not very bright, it is recommended to adjust the gain settings.	To adjust the exposure time, move to the option and use the RIGHT/LEFT ARROW buttons.
Gain	The gain setting allows you to adjust the brightness of the image acquired by the sensor by amplifying the signal transmitted by the CMOS to the processing unit. Increasing the gain setting, however, also increases the disturbance on the image which decreases its quality.	To adjust the gain setting, move to the option and use the RIGHT/LEFT ARROW buttons.
Negative	Select the option to enable the inversion of the grey tones. This creates a negative image compared to the one currently acquired by the sensor (i.e. white turns to black and vice-versa).	Press the SET button to enable/disable the option.



Once the camera settings have been completed, it is possible to return to the Setup menu by pressing the **TEACH** button. This procedure saves all the modifications made to the settings.

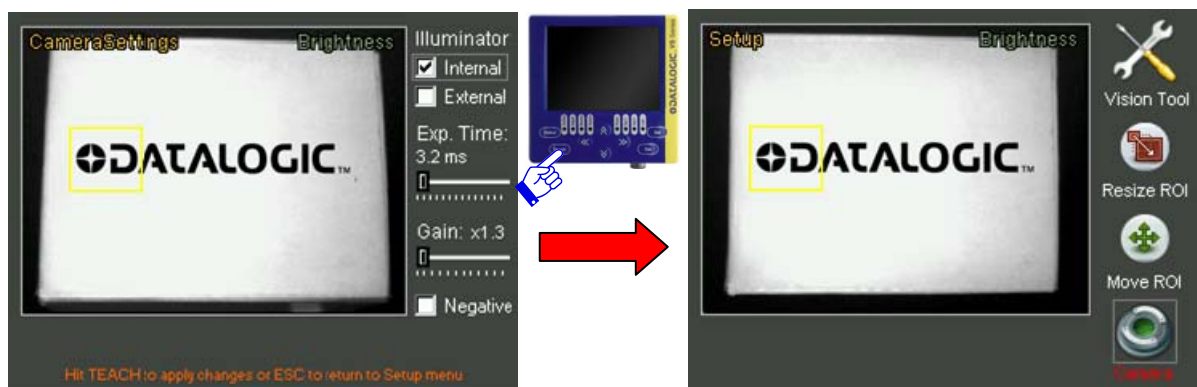

If you wish to exit the control panel without saving the modifications, simply press the **ESC** button. The configurator will display a pop-up message asking the user if he wishes to save the settings. Select **NO** using the **ARROWS** and press **SET** to exit without saving.

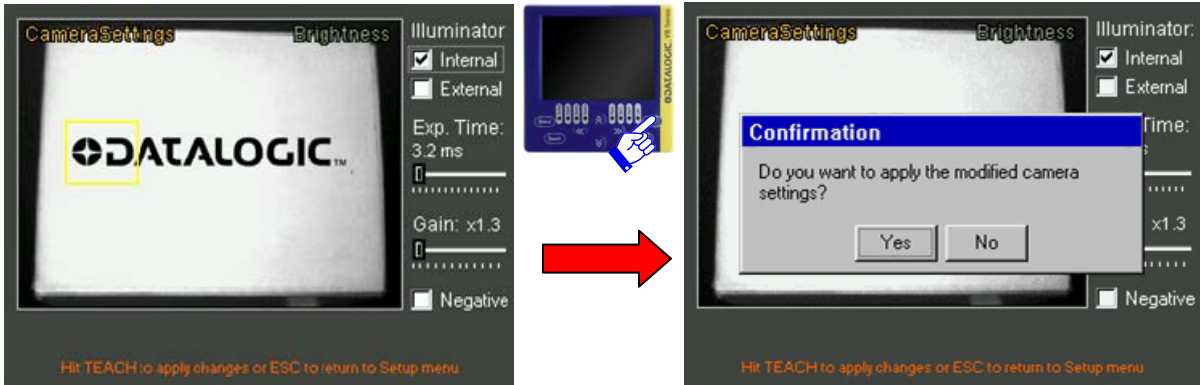



Once you have completed the camera settings, you can select the inspection tool. To select this option, use the **ARROWS** on the **VISION TOOL** icon and press the **SET** button.



- ▶▶ Use the **ARROW** buttons to scroll the menu options. Press the **SET** button to confirm the inspection tool to be used.



The chart given below provides a brief summary of the controls that can be selected. Please refer to Chapter 7 for further information and details on the inspection tools.

Tool	Icon	Function
Brightness		Calculation of the average brightness value inside an area
Contrast		Calculation of the maximum contrast value inside an area
OCV		Font printing test
Pattern Match		Search for a pattern inside an area
Position		Control of the position of details

Width		Control of the size of details
Edge Counting		Counting of details along an edge
Pattern Count		Counting of patterns inside an area

Once the inspection tool has been selected, it is necessary to position and size the regions of interest (ROI) to be monitored.

The meaning of the ROI varies according to the control tool selected. The chart below provides a rough indication on the meanings. Please refer to Chapter 7 for further details.

Tool	ROI description
Brightness	This identifies the area within which the algorithm calculates the average brightness value
Contrast	This identifies the portion of the field range within which the algorithm calculates the maximum contrast value
Position	This identifies the area within which significant variations in brightness are searched (edge ) and mainly distinguish the edges of details to be inspected
Width	As in the case of position control, this defines the area within which the algorithm searches the edges on the detail of which it is necessary to measure the width
Edge Counting	This describes the area within which a search is made for edges () which are then counted by the algorithm
Pattern Match	This defines the pattern (detail) to be searched within the whole focus range
OCV	This describes the portion in which the device searches for the characters to be monitored
Pattern Count	This describes the pattern (detail) to be counted within the whole focus range

To modify the position of the ROI, move to the *Move ROI* icon and then press **SET**.



NOTE: The procedure used to reposition and resize the ROI indicated herein can be applied to all inspection tools available on the sensor. The only exceptions are the Pattern Match and Pattern Count which require two inspection areas to be set and therefore have a specific procedure. Please refer to Chapter 7.7 for further details.



It is now possible to move the ROI using the **ARROW** buttons. The coordinates (expressed in pixels) of the top left hand corner of the ROI are displayed at the bottom of the screen. Once you have

achieved the desired position, press the **TEACH** button to save the settings and return to the Setup menu. Press the **ESC** button to return to the Setup menu without saving the modifications (the system will request confirmation on the saving option).

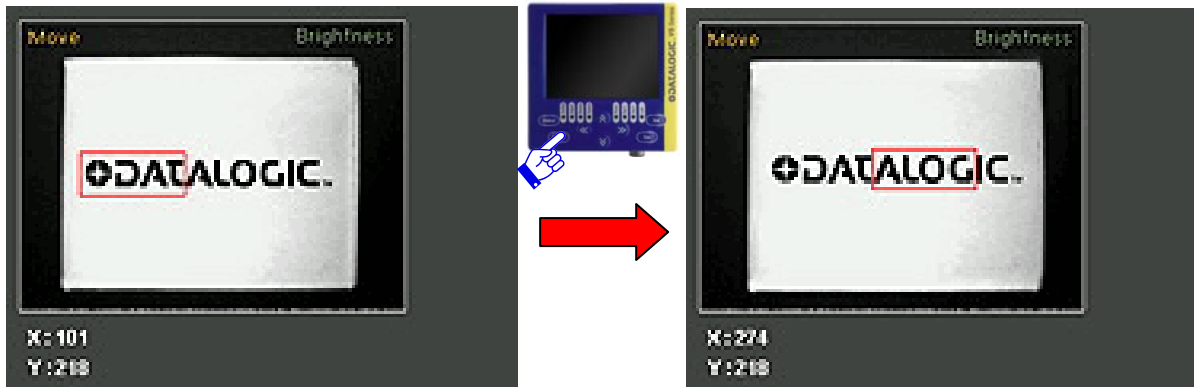

If you wish to modify the ROI size, select the *Resize ROI* from the Setup menu (using the **SET** button again). It is now possible to increase or decrease the ROI size using the **ARROW** buttons. The size (expressed in pixels) of the current ROI are displayed at the bottom of the screen. Once you have achieved the desired size, press the **TEACH** button to save the settings and return to the Setup menu. Press the **ESC** button to return to the Setup menu without saving the modifications (the system will request confirmation on the saving option).

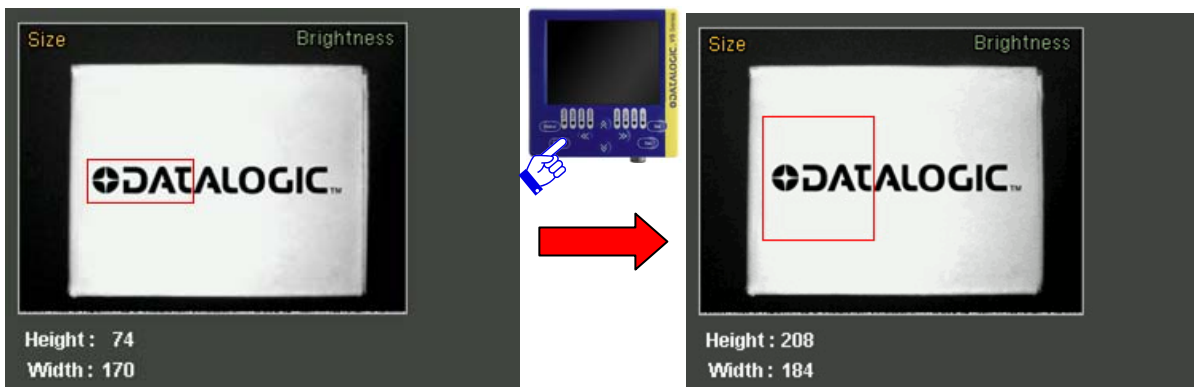

When the ROI position and size are complete, you can move on to the next configuration step. To proceed, press the **STATUS** button. The Set/Net LED switches off and the Adjust LED lights up.



5.5. Step 2 - Configuration of the selected inspection tool

In step 2 of the configuration process you will define the settings which will regulate the inspection tool selected in step 1.

The configurator display is basically organised as seen in step 1. The settings that the user can modify are displayed on the right, whilst the rest of the screen displays the image acquired by the sensor. The name of the current setting is also displayed at the bottom of the screen, with a brief description of the same and the current values.

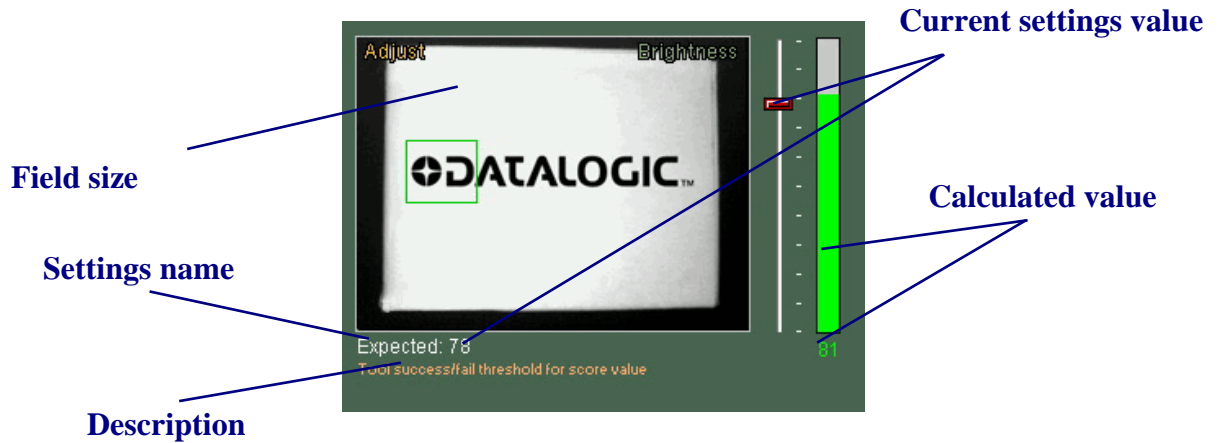

Settings are displayed one at a time. To move from one setting to another, use the **LEFT/RIGHT ARROW** buttons. To adjust the current setting, use the **UP/DOWN ARROW** buttons. By pressing the button, the value will increase/decrease by one unit. To modify the value faster, press and hold the button.

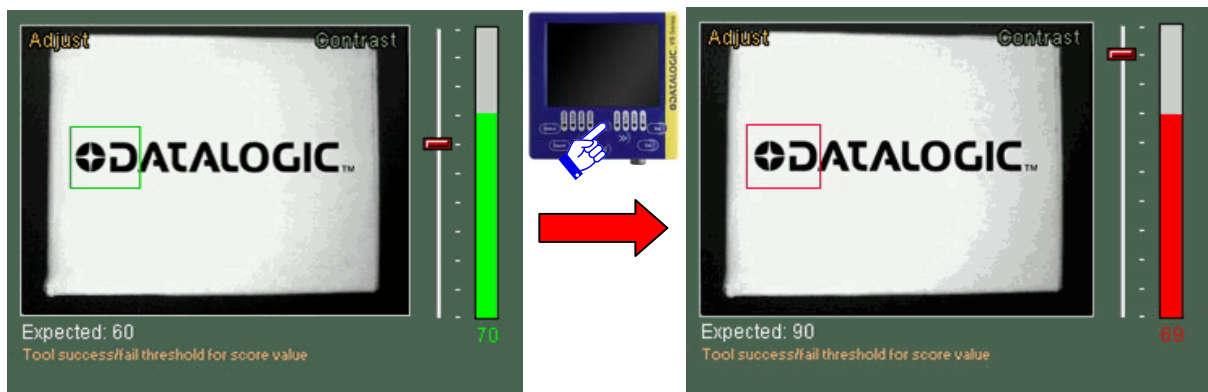



The settings in this section vary according to the selected inspection tool. Please refer to Chapter 7 for further details.

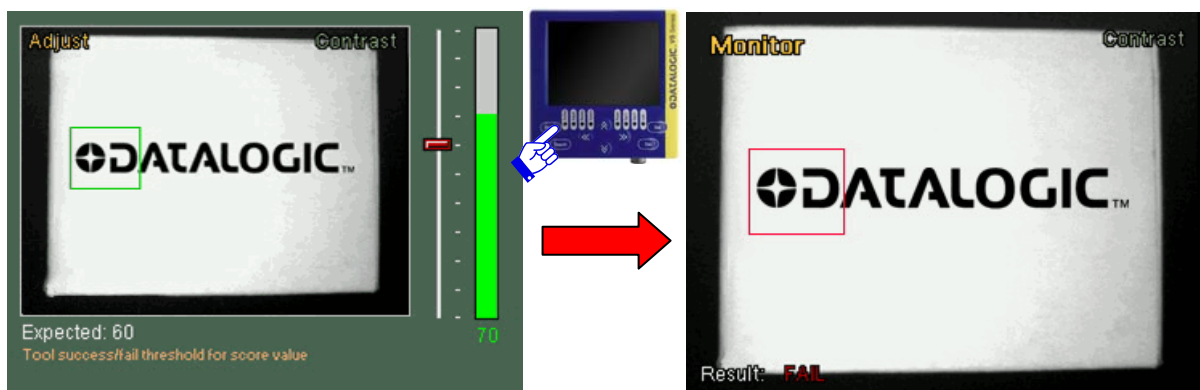

Once the settings have been completed, it is possible to proceed to the next stage by pressing the **STATUS** button. The Adjust LED switches off and the Monitor LED lights up.

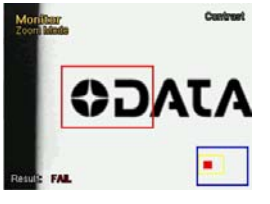
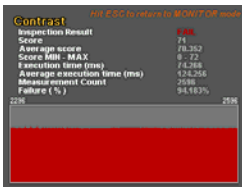

5.6. Step 3 - Inspection tool function check

In Monitor Mode, it is possible to check that the inspection tool settings entered during the configuration step function correctly. The user can choose from five different monitoring modes. The chart below provides a description of the main features of the five available modes with instructions on how to enable viewing.

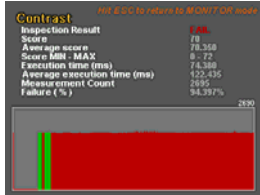
Mode	Example	Enable	Description
Camera Mode		ARROW DOWN	The monitor displays the sensor field focus in full screen mode. No type of information is indicated regarding inspection results.
Monitor Mode		ARROW UP	The monitor displays the sensor field focus in full screen mode. The following information is also displayed: <ul style="list-style-type: none"> • Current control status (top right hand corner) • ROI • Inspection result (bottom left hand corner)
Fail Mode		LEFT ARROW	The monitor displays the image of the last inspection which had negative (fail) result (fault)
Zoom Mode		RIGHT ARROW	An image of the sensor field focus is displayed on the monitor with 200% zoom. A rectangle in the bottom right-hand corner indicates the position of the displayed area compared to the overall image and the ROI position. To move the zoom area, use the ARROW buttons. Press ESC to exit zoom mode.
Statistics		SET BUTTON	Statistics on the inspection results are displayed on the monitor. The information displayed include: <ul style="list-style-type: none"> • <u>Inspection result</u> Current inspection outcome • <u>Score</u> Current inspection result • <u>Average score</u> Average calculated score • <u>Score MIN-MAX</u> Minimum and maximum calculated score • <u>Execution time (ms)</u> Total inspection execution time • <u>Average execution time (ms)</u> Average total inspection execution time • <u>Measurement count</u> Number of inspections executed

			<ul style="list-style-type: none"> • Failure (%) % of failed inspections of the total number executed <p>It is now possible to modify the view scale for the graph below using the RIGHT/LEFT ARROW buttons. In particular:</p>  <p>The graph is compressed along the x-axis using a factor of 10.</p>  <p>The graph is compressed along the x-axis using a factor of 100.</p> <p>Press SET to exit the statistics mode.</p>
--	--	--	--

If the results of the defined inspection are not as desired, it is possible to press the **ESC** button to return to the previous configuration step. Press once to return to the Adjust menu, press twice to return to the Setup menu.

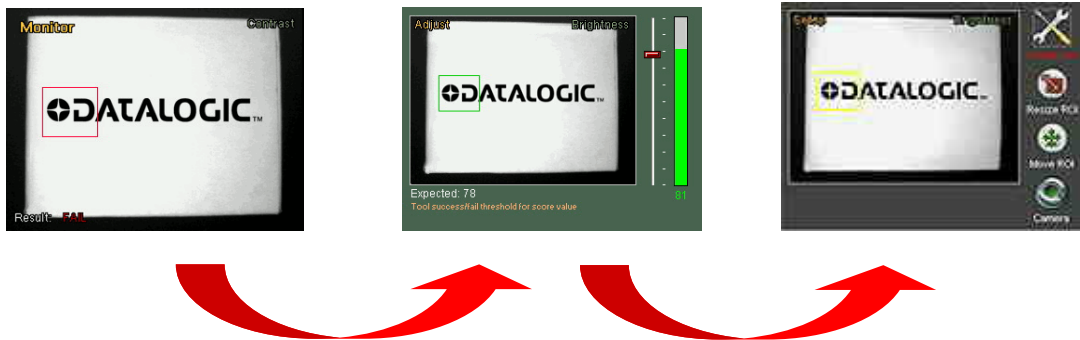

When you are satisfied with the results, proceed to the fourth and final configuration step by pressing the **STATUS** button: The Monitor LED switches off and the System LED lights up.

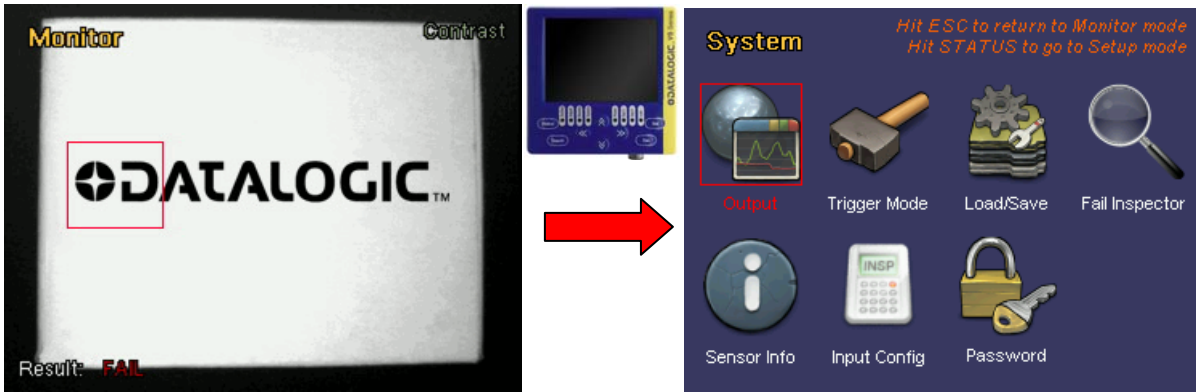

NOTE: in Monitor Mode it is possible, as already mentioned, to check that the inspection settings function properly. It is however important to highlight that the inspection displayed on the VSC does not correspond to that saved on the sensor until the user saves it in one of the memory slots on the sensor. For this reason, every time the user makes any modifications to the configuration settings, in monitor mode, the floppy disk icon in the bottom right hand corner will flash reminding the user to save the inspection.

Example:

Let's connect the VSC to a DataVS1 which is currently monitoring. The device will switch to Monitor Mode and display the current sensor functions.



*We then decide to increase the minimum acceptance threshold of the pattern match tool as sometimes the inspection does not provide the desired results. We therefore press **ESC** to return to Adjust mode and press **ARROW UP** to increase the threshold. We now return to Monitor mode to check the results by pressing the **STATUS** button.*



*The floppy disk icon will flash in the top right hand corner. If we now disconnect the VSC from the DataVS1, we would lose all the modifications. To save the new settings, press **STATUS** to enter the System menu and use the bank set we save the inspection to a sensor memory slot (please see paragraph 5.7 for further details).*

The standard save procedure is described in detail in paragraphs 5.7 and 6.3. It is also possible to perform a quick save of the settings as follows. Press the **TEACH** button when in Monitor mode. A window will appear with a summary of the modifications made to the current inspection and the memory slot currently enabled.

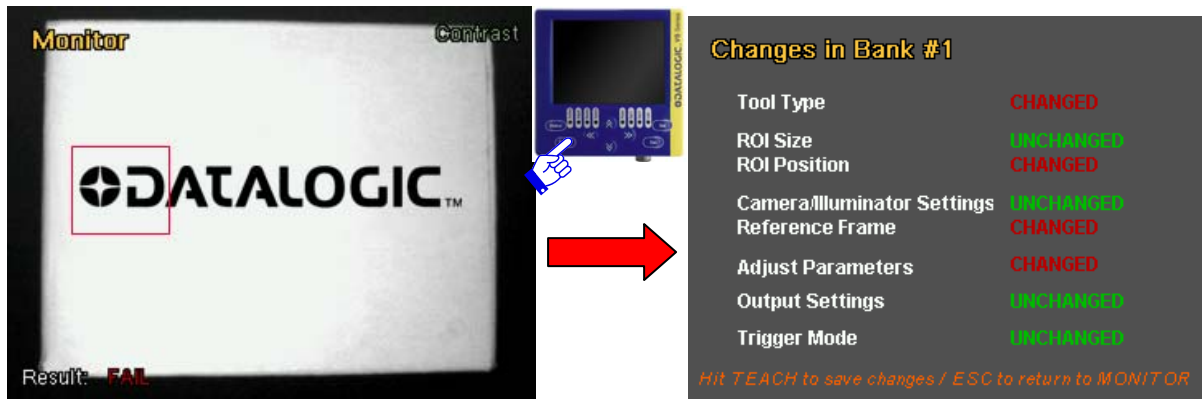

To save the setting, simply press the **TEACH** button again. Press **ESC** if you wish to return to Monitor mode.

5.7. Step 4 - Output definitions and saving the inspection settings to the sensor

When you enter System Mode, the VSC will display the following menu



Before saving the inspection to the sensor, it is necessary to set the digital outputs. The sensor has three configurable digital outputs, for each of these you can set the operating mode, duration and delay (duration and delay are common settings for all three outputs).

To define the behaviour of the outputs according to the result of the set control, use the **ARROW** buttons to move to the **OUTPUT** icon and press the **SET** button.

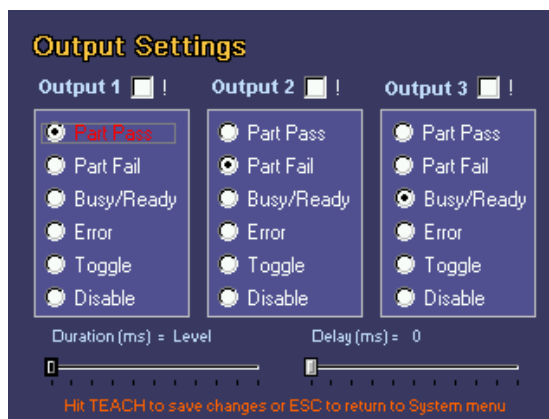

As seen in the image below, it is possible to assign a different behaviour to each output.

Option	Behaviour
Part pass	The output is enabled when the inspection gives a positive result. If a failure occurs it remains low.
Part fail	The output is enabled if a failure occurs. If the inspection gives a positive result, it remains disabled.
Busy-Ready	The output takes on value 1 (Busy) for the entire time the sensor takes to acquire and process the image. The output takes on value 0 (Ready) when the sensor is ready to acquire a new image. If the image is acquired under the control of an external signal (hardware trigger), the output will take on value 1 on receiving the signal.
Error	This indicates an error on the sensor.
Toggle	The output will indicate alternately the logic values 1 and 0 each time it acquires and processes an image. In this configuration there is no relation between the value indicated on the output and the result of the processed image.
Disable	The output is disabled

By default the three outputs have the following settings:

- **OUTPUT 1:** Part pass
- **OUTPUT 2:** Part pass
- **OUTPUT 3:** Part Pass

To select the required behaviour, use the **ARROW** buttons to select the option and press the **SET** button.

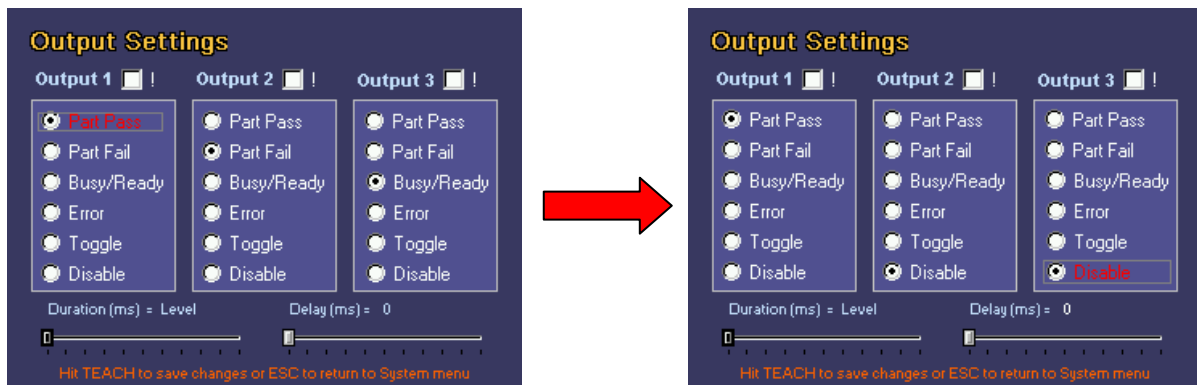

Each output can also be configured in negative logic. To invert the function logic, use the **ARROW** buttons to select the option at the top with an exclamation mark, and press the **SET** button.

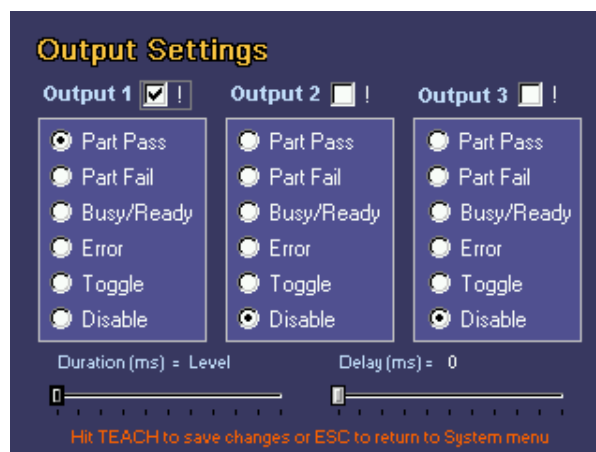

Two other parameters which can be configured can be seen at the bottom of the screen.

- **Duration** this indicates the length of time (in ms) the output must maintain the last acquired value; this is mainly used for Part Present, Part Pass and Part Fail modes.
- **Delay** indicates after how long the output shall display the last acquired result. It delays the time the output signal is maintained if the delay is longer than the processing time, therefore from when the image is acquired to when the outputs are enabled.

These two parameters can be set using the **LEFT/RIGHT ARROW** buttons.

Once the settings have been completed, it is possible to return to the System menu and save the modifications by pressing the **TEACH** button. Press **ESC** if you wish to exit without saving the modifications. The system will display save request message. To confirm exit and ignore the modifications, use the **ARROWS** to reach **NO** and press **SET**.

The configuration phase has been concluded when all the output settings have been completed. Now you must render the modifications permanent and save the inspection to the sensor databank. Select the **LOAD/SAVE** option from the main menu, and press the **SET** button.



It is possible to manage the sensor memory slots from the new menu displayed on the screen. DataVS1 has a total of 8 databank areas where it is possible to save 8 different inspections which can be recalled as required.

To save the configured inspection, select the destination databank using the **ARROW** buttons and then press **SET** to confirm. Then move the cursor to **SAVE** and press **SET**.



On completing these configuration procedures, the user can:

- disconnect the VSC and use the sensor in stand-alone mode
- use the VSC to view the results of the inspection. To do this, enter the System menu and press the **ESC** button to return to Monitor mode

6. VSC CONFIGURATOR: ADVANCED FUNCTIONS

The previous chapter described the procedure used to create a new inspection for DataVS1. Besides the functions illustrated above, there are other user settings on the VSC configurator which can be reached from the System menu.



These functions are listed and individually described below.

6.1. Output

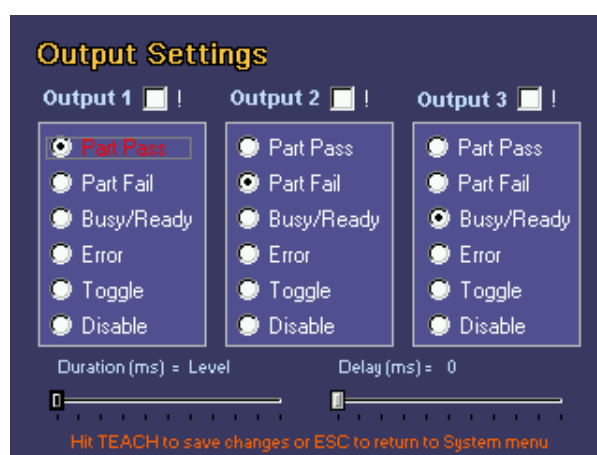

From the *Output Settings* menu it is possible to configure the 3 digital outputs on the sensor. A different behaviour can be associated to each output.

Option	Behaviour
Part pass	The output is enabled when the control gives a positive result. If a failure occurs it remains low.
Part fail	The output is enabled if a failure occurs. If the control gives a positive result, it remains disabled.
Busy-Ready	The output takes on value 1 (Busy) for the entire time the sensor takes to acquire and process the image. The output takes on value 0 (Ready) when the sensor is ready to acquire a new image. If the image is acquired under the control of an external signal (hardware trigger), the output will take on value 1 on receiving the signal.
Error	This indicates an error on the sensor.
Toggle	The output will take on alternately the logic values 1 and 0 each time it acquires and processes an image. In this configuration there is no relation between the value taken on by the output and the result of the processed image.
Disable	The output is disabled

By default the three outputs have the following settings:

- **OUTPUT 1:** Part pass
- **OUTPUT 2:** Part pass
- **OUTPUT 3:** Part Pass

To modify the behaviour of the outputs, move the cursor with the **ARROWS** then use **SET** to select the desired option.

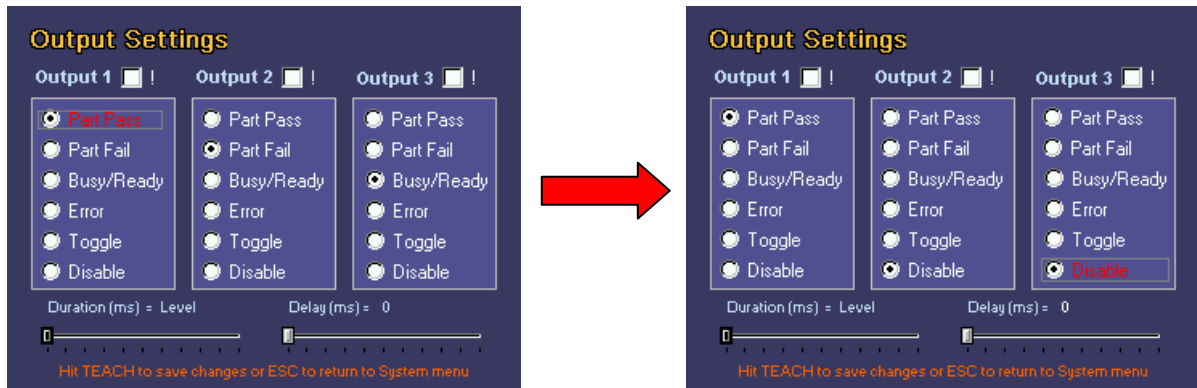

Each output can also function in negative logic. On enabling this option, the output will behave in the opposite manner compared to standard mode: that is it will take value 1 instead of 0 and vice-versa. To enable negative logic simply flag the box next to the output name. To do this, use the **ARROW** buttons to move to the box and press the **SET** button.

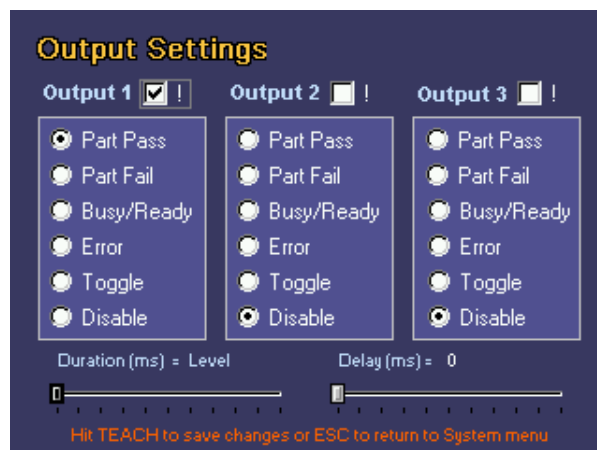

The final parameters which can be set regarding the behaviour of digital outputs are *duration* and *delay*. Please note that these parameters are common to all the digital outputs and therefore it is not possible to set different values for different outputs.

- **Duration** this indicates the length of time (in ms) the output must maintain the last acquired value; this is mainly used for Part Present, Part Pass and Part Fail modes.
- **Delay** indicates after how long the output shall display the last acquired result. It delays the time the output signal is maintained if the delay is longer than the processing time, therefore from when the image is acquired to when the outputs are enabled.

These two parameters can be set using the **LEFT/RIGHT ARROW** buttons.

Once the settings have been completed, it is possible to return to the System menu and save the modifications by pressing the **TEACH** button. Press **ESC** if you wish to exit without saving the modifications. The system will display save request message. To confirm exit and ignore the modifications, use the **ARROWS** to reach **NO** and press **SET**.

6.2. Trigger Mode

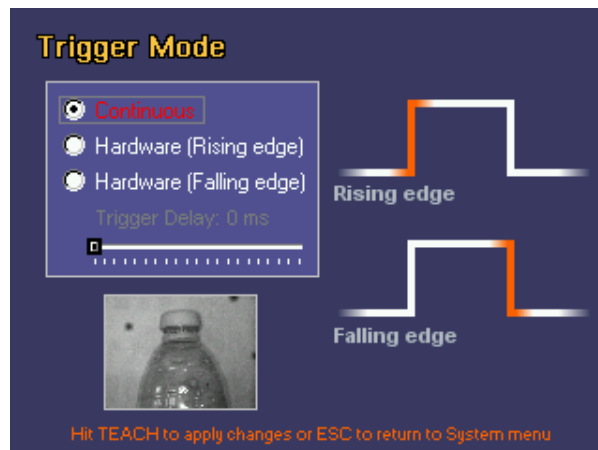

The term trigger means a signal generated by an event that provokes another event.

In our instance, the trigger is a signal generated by a device that triggers image acquisition.

When the sensor is used to inspect moving objects, it is important to ensure that the object is inside the detection area at the precise instant the image is captured for processing. To this purpose, there are 3 "trigger" options available in the System menu:

- Continuous
- Hardware - Rising edge
- Hardware - Falling edge

Continuous trigger

The acquisition of the image to be processed is performed at the fastest speed possible. Each individual image is acquired and immediately processed; as soon as the sensor is ready, the next image is acquired and so on.

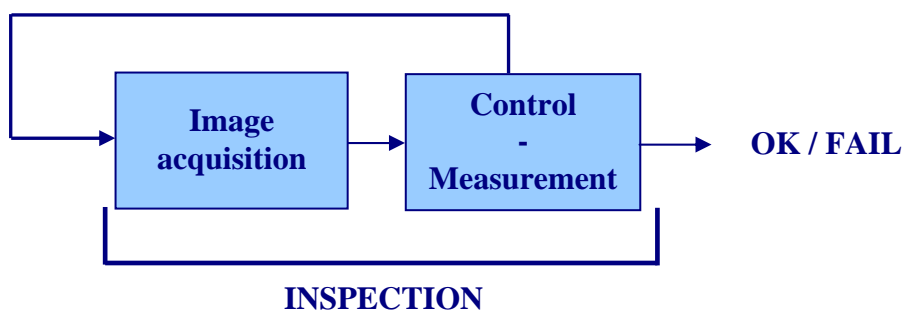

This type of trigger is useful to test the settings of an inspection tool: In fact, it is possible to check the settings applied to the images acquired by the sensor.

Trigger hardware

The image acquisition signal is sent by an external device (e.g. a photocell), the signal naturally has a rising and falling edge.

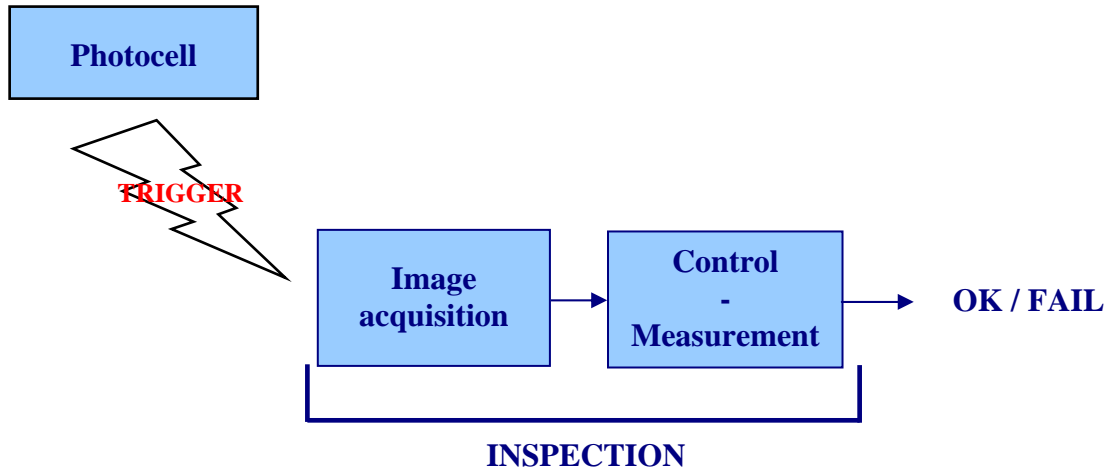

If the "Rising Edge" is selected, the image acquisition signal follows the rising edge of the external device.

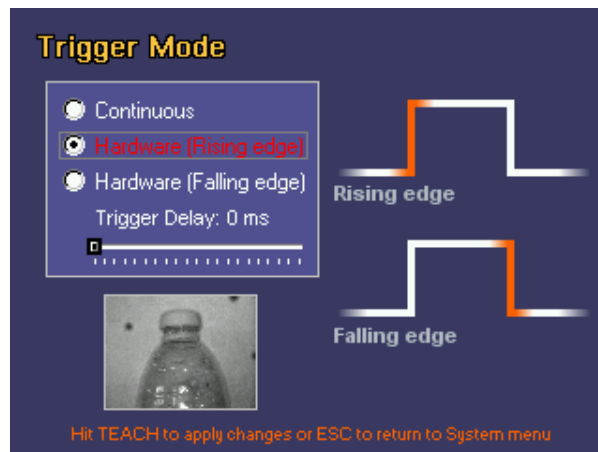

If the "Falling Edge" is selected, the image acquisition signal follows the falling edge of the external device.

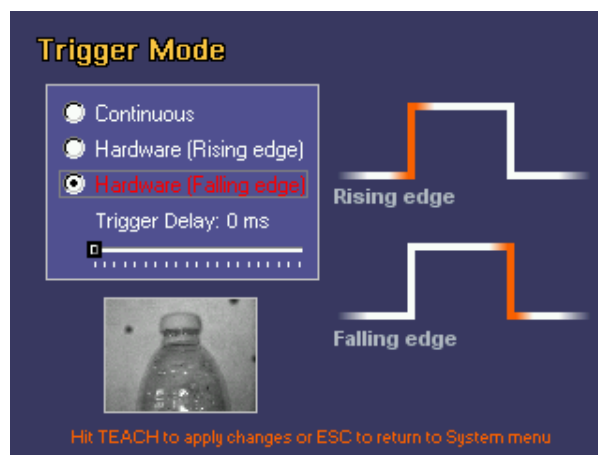

It is also possible to set a delayed image acquisition compared to the trigger signal received for both hardware triggers. To set the delay value, simply use the slider found at the bottom of the screen using the **RIGHT/LEFT ARROW** buttons.

Example:

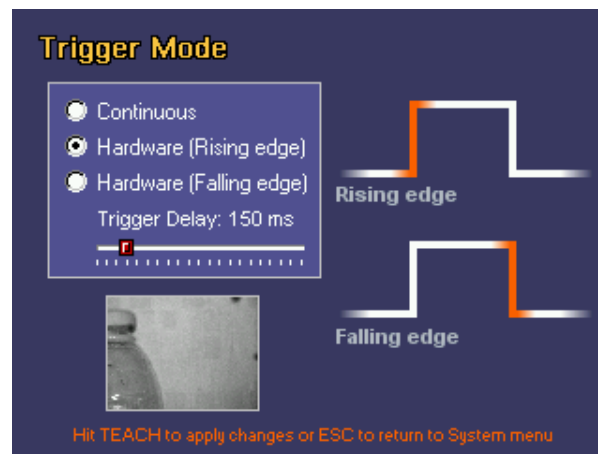

The image acquisition is delayed by 150 ms compared to the rising edge of the trigger signal.

6.3. Load/Save

The term load/save menu identifies the control panel used to manage the databank areas available on the sensor.



NOTE: The load/save menu is the only access point to the FLASH memory installed on the sensor. During all configuration steps in fact, a RAM type memory is used which is reset each time the device is powered down. Therefore, when the current settings are modified, and you wish to render them permanent, it is necessary to save the inspection tool using the load/save menu.

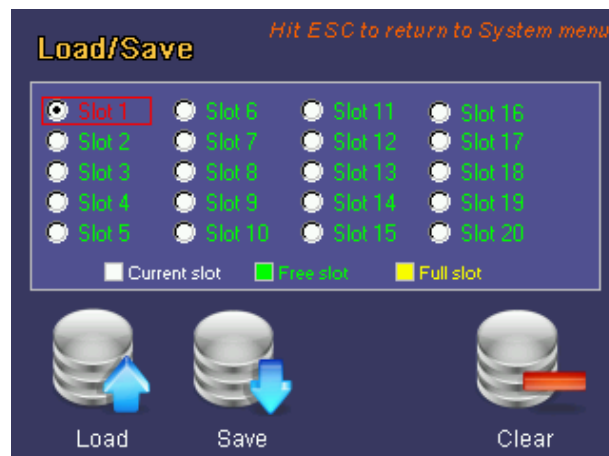

The 8 memory slots available on the sensor are displayed at the top of the screen. Each bank can take on three different status modes (identified by 3 different colours):

- **Current bank (white)**
Current memory slot
- **Free bank (green)**
Free bank
- **Full bank (yellow)**
Memory slot full. If you save a new inspection to this slot, it will overwrite the previous version.

To select the memory bank you wish to use, move the cursor using the **ARROW** buttons and press the **SET** button to confirm.

When you are on the selected memory bank, you can perform three different operations which can be recalled using the icons at the bottom of the screen:

- **Load: This loads the inspection memorised on the selected bank.**

Press the **SET** button to load the selected inspection onto the device. After a few seconds, a confirmation message is displayed on the device. After pressing **SET** again you will be asked if you wish to use the loaded inspection as the default inspection the next time the device is rebooted. It is possible to select the option using the **ARROW** buttons and then press **SET** to confirm.

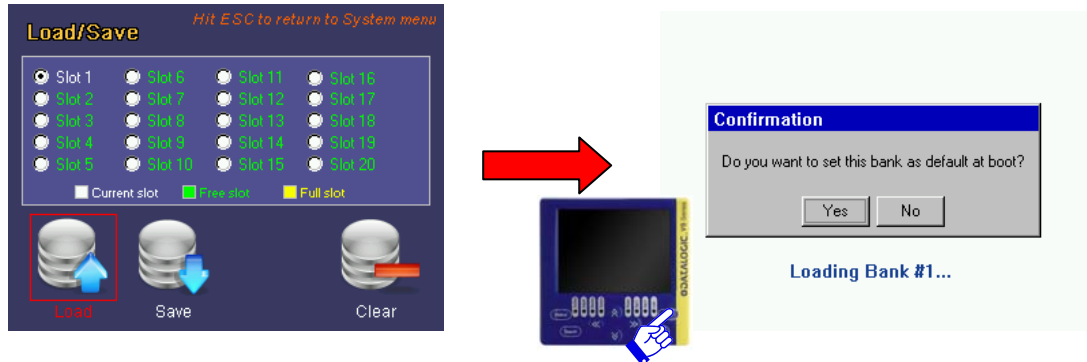

- **Save: this saves the current inspection to the selected bank.**

Press the **SET** button to save the current inspection onto the device. If the selected slot is not free, a message will appear on the screen asking if you wish to overwrite the inspection currently saved in this databank. Use the **ARROW** and **SET** buttons to scroll and select the option. After a few seconds, you will be asked if you wish to use the loaded inspection as the default inspection the next time the device is rebooted. It is possible to select the option using the **ARROW** buttons and then press **SET** to confirm.

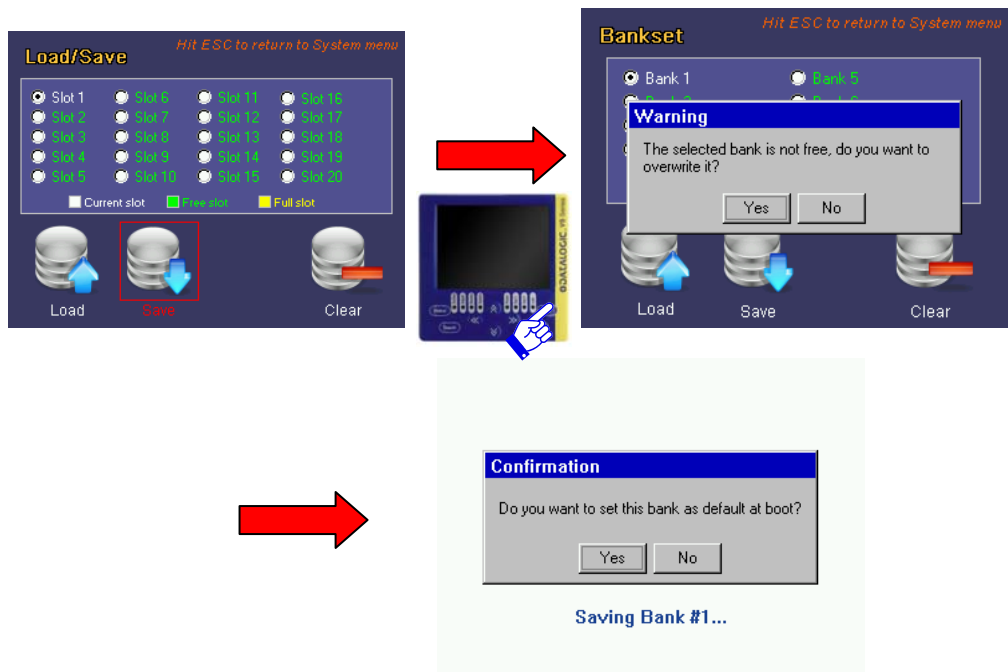

- **Clear: This deletes the inspection memorised on the selected bank.**

Once the **SET** button has been pressed, the device requests delete confirmation. The user can select the option using the **ARROW** buttons and then press **SET** to confirm.

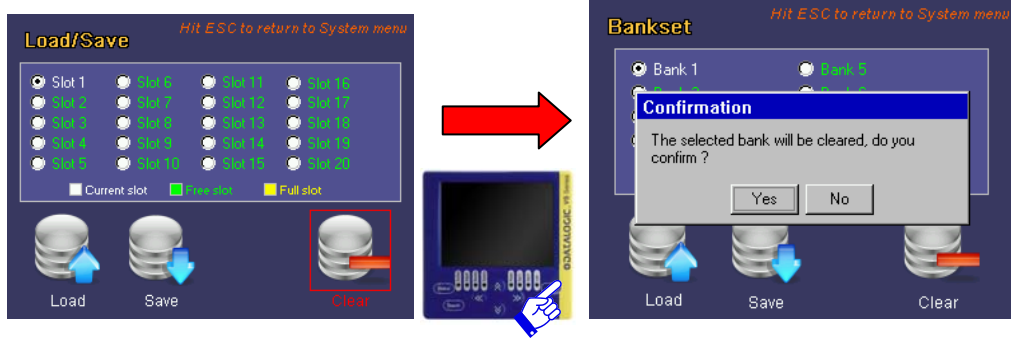

It is possible to exit the bankset at any time by pressing the **ESC** button.

6.4. Fail Inspector

The fail inspector is a tool which permits the user to recall the images of the last inspection failures. The sensor can log a maximum of 10 images: Where necessary, the 11th fail will overwrite the first failure logged on a FIFO basis.

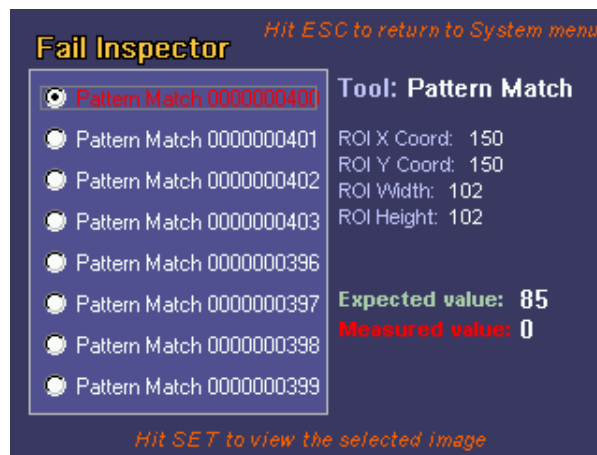

The list of the last 10 fails is displayed on the left side of the screen. Use the **UP/DOWN ARROWS** to scroll the fail list. Some information data is displayed on the right for the selected fail. More precisely:

Label	Description
Tool	Name of the current tool
ROI X Co-ord.	Value of the X co-ordinate (expressed in pixels) from the top left hand corner of the ROI
ROI Y Co-ord.	Value of the Y co-ordinate (expressed in pixels) from the top left hand corner of the ROI
ROI width	Width (expressed in pixels) of the ROI
ROI height	Height (expressed in pixels) of the ROI
Expected value	Acceptance threshold value set by the user
Measured value	Value calculated by the test

Press the **SET** button to view the selected fail.

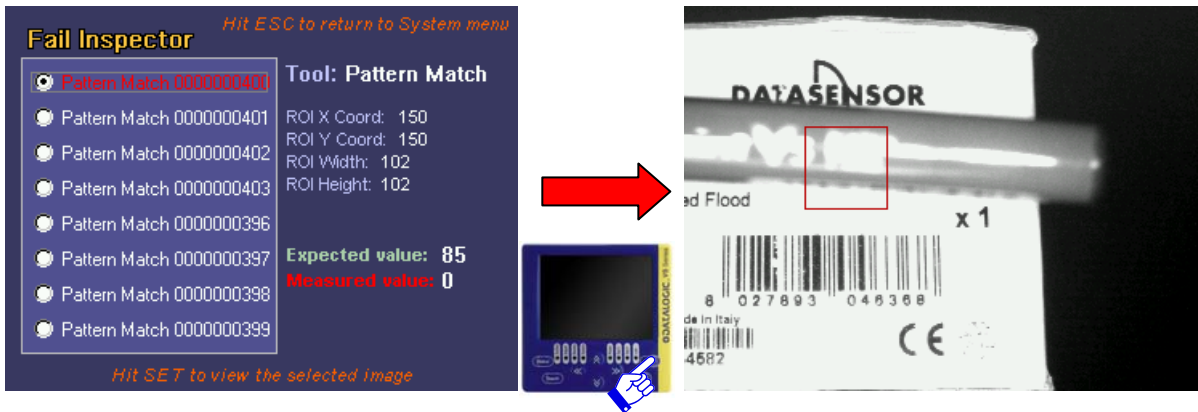

It is possible to scroll the various fails using the **RIGHT ARROW** and **LEFT ARROW** buttons. To return to the main menu of the fail inspector, press the **ESC** key.

6.5. DataVS1 Ver.



From the *DataVS1 Version* control panel it is possible to check the software version currently loaded on the device and its release date. To return to the main menu, press the **ESC** key.

6.6. Input Config



Input Config menu allows for selecting Digital Inspection Switching protocol and enable digital TEACH in on DataVS1. Two are the available protocols:

- Standard
Inspection Switching Protocol without feedback from sensor.
- Expert
Inspection Switching Protocol with feedback from sensor.



NOTE: For both Standard and Expert protocols you should configure the minimum pulse width accepted by the sensor: MIN_PULS_WIDTH. The default MIN_PULSE_WIDTH value is 10 ms.

6.6.1. Standard Protocol

Protocol description

Il protocollo è composto da due fasi handshake, chiamate *prologo* e *epilogo*. In base a questo protocollo, il sensore non rende disponibile nessun segnale di feedback (segnale ACKNOWLEDGE)

I PIN degli I/O digitali coinvolti nel Protocollo Standard sono 5:

- PIN 1: Select Input. Viene usato in entrambe le fasi di handshake, per avvisare il sensore dell'arrivo di una richiesta di cambio dell'ispezione in esecuzione e comunicare al sensore il numero dello slot dell'ispezione da commutare.
- PIN 4: Output 1.
- PIN 5: Output 2.
- PIN 6: Output 3.

Fondamentalmente il prologo è composto da tre impulsi di durata 10-100 ms e un duty-cycle del 50%. Il primo impulso apre la finestra del prologo che ha una durata massima di $Y = X*6 + \text{delta}$ ms (dove X è la durata dell'impulso selezionata e *delta* è un margine impostato come il 5% del valore corrente di $X*6$), durante la quale sono attesi 3 impulsi per dare il via alla sezione di selezione della ispezione. Al termine del prologo, se vengono contati soltanto 3 impulsi si passa alla fase successiva.

Nella finestra di selezione dell'ispezione, della durata di $Y = X*40 + \text{delta}$ ms (dove X è la durata dell'impulso selezionata e *delta* è un margine impostato come il 5% del valore corrente di $X*40$), viene contato il numero di impulsi che corrisponde al numero di ispezione selezionato. Se il numero di impulsi non corrisponde ad una ispezione valida la richiesta viene scartata.

La figura seguente mostra l'immagine (acquisita tramite oscilloscopio) del processo di selezione dell'ispezione numero 8 con gli ingressi digitali generata con un PLC.

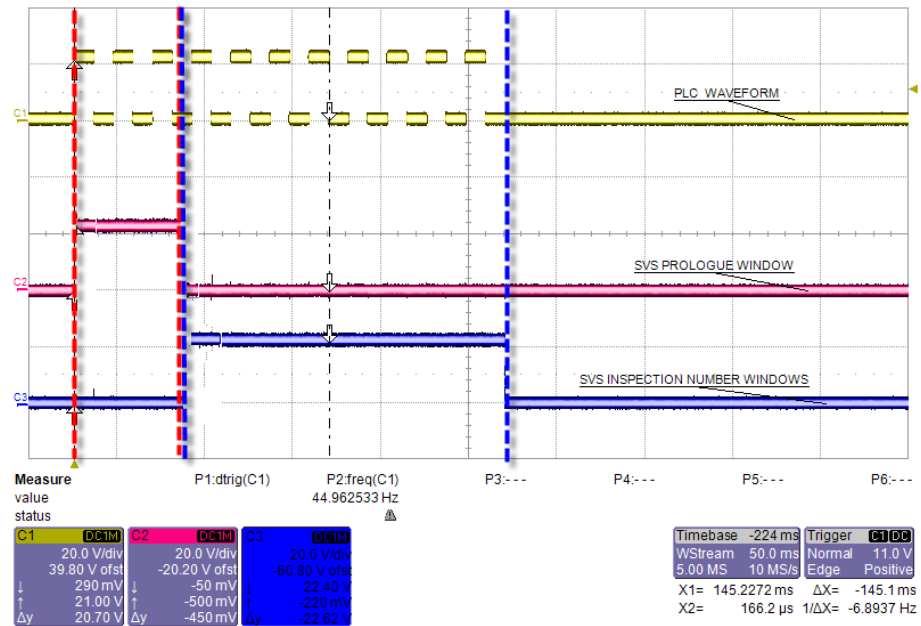

Selection of the inspection number 8

Protocol selection

To enable the standard protocol on the sensor select Basic Inspection Selection protocol radio button from Input config menu.

Adjust minimum Pulse duration slider according to the width of pulses received by the sensor; minimum pulse duration set on the sensor must be lower than pulse width used for changing current inspection.

Inspection switch timing

Because of Inspection loading can take some processing time (basically the sensor needs to perform an Inspection teaching phase on the reference image before going in run mode), a unique and definitive timing of the inspection change process is not available because it will depend on the inspection time itself.

If the inspection use very fast tools, for example Position or Width, it will be quite fast (hundred of milliseconds), if the inspection is quite slow, for example a difficult pattern match, the delay will be greater maybe in the 1-2 seconds range.

During the inspection switch process, the sensor stops acquiring new images and enter an idle status. When the switch is complete, the sensor blinks once and then starts the new inspection activity. Anyway it is possible to check the current running inspection using the Graphic User Interface.

6.6.2. Expert Protocol

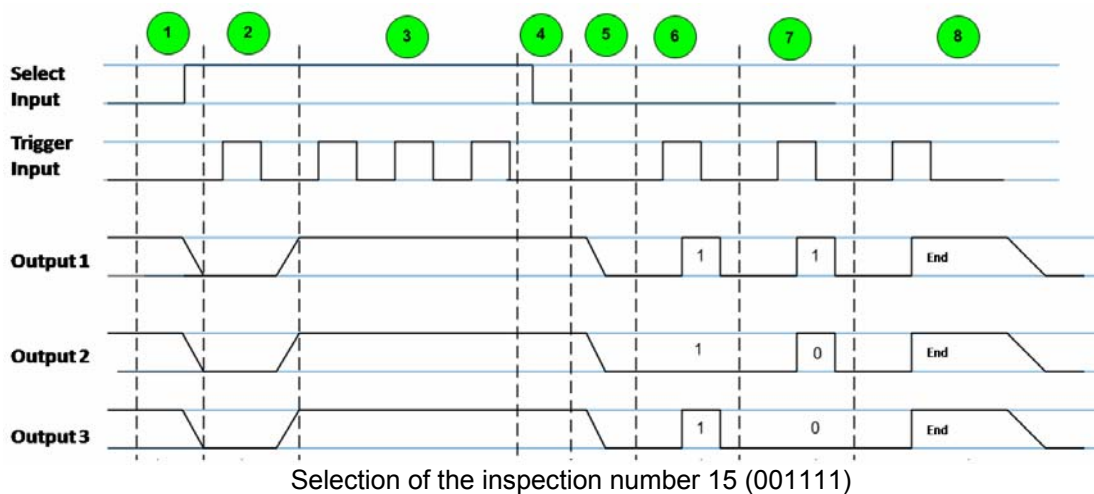

Protocol Description

The Expert protocol for Inspection switching on sensor is based on an 8 phases handshake. According to this protocol the sensor makes available an ACKNOWLEDGE message, representing a feedback on the Inspection switching operation.

Five are the digital I/O PIN involved in the Expert protocol:

- ☑ PIN 1: Select Input. It is used in the first 4 phases of the handshake, to alert the sensor of an incoming Inspection switching request.
- ☑ PIN 8: Trigger Input. It is used to communicate to the sensor the Slot number of the Inspection to switch to and to retrieve Inspection switching ACKNOWLEDGE.
- ☑ PIN 4: Output 1.
- ☑ PIN 5: Output 2.
- ☑ PIN 6: Output 3.

Following a description of each phase.

Phase 1: Select Input HIGH. ALL sensor outputs LOW.

Select Inputs signal (from PLC to sensor) switches from LOW (0V) to HIGH (24V), representing an Inspection switching request. As a reaction the sensor sets all outputs to LOW.

 **Note:** in the worst case the time interval occurring between the instant when the Select Inputs signal arrives to the sensor and the instant when the sensor set outputs to LOW can vary depending on the current running Inspection. After receiving the Select Input signal the sensor will finish the current Inspection cycle and then will rise down outputs.

Phase 2: Trigger Input HIGH. All sensor outputs HIGH.

The Trigger Input is set from PLC first time HIGH. The sensor sets all outputs to HIGH, entering the wait for Inspection selection phase.

Phase 3: Inspection selection.

The sensor counts any incoming Trigger Input pulses as long as the Select Input is HIGH.

 **Note:** a timeout T1 will end phase 3 if Select Input signal doesn't go LOW within 4 seconds. If T1 occurs the Inspection selection will be ignored and the sensor will resume the previous running Inspection.

Phase 4: Select Input LOW. Inspection selection verification.

The sensor performs an integrity verification on the number of received Trigger Input pulses.

 **Note:** this phase can take MIN_PULSE_DUR milliseconds at least.

 **Note:** if the number of received Trigger Input pulses is 0 or higher than 20 (number of available Memory Slots) the Inspection selection will be ignored and the sensor will resume the previous running Inspection. In this case, as feedback (phases 5, 6, 7), the sensor will give the Slot number of the previous running Inspection.

Phase 5: All sensor outputs LOW.

After the Select Input is set to LOW by the PLC (Phase 4) and the MIN_PULSE_DUR interval has exceeded the sensor sets all outputs LOW. This transition means that the sensor is now ready to send the ACKNOWLEDGE message.

 **Note:** while Select Input signal is LOW but outputs are still HIGH the sensor will not accept, count or response to any Trigger Input pulse.

Phase 6: Trigger Input HIGH. Sensor LSB AKNOWLEDGE BITS.

The first Trigger Input pulse after phase 5 activates the Inspection selection acknowledge. The sensor sets its outputs in order to represent the LSB (Less Significant Bits) of the binary coding of the Inspection selection number, where output 1 represents the LSB of the first 3 bits and output 3 represents the MSB (Most Significant Bit) of the first three bits.

Example:

- Inspection number, binary coded, is represented by 6 bits: **b1 b2 b3 b4 b5 b6**. In **phase 6** only LSB are sent: **b4, b5, b6**.
- Acknowledge bits, phase 6: **output1=b6, output2=b5, output3=b4**.

 **Note:** a timeout T2 will end phase 6 if no Trigger Input signal is received after phase 5 within 4 seconds. If T2 occurs the Inspection selection will be ignored and the sensor will resume the previous running Inspection.

Phase 7: Trigger Input HIGH. Sensor MSB ACKNOWLEDGE BITS.

The second Trigger Input pulse after phase 5 activates the Inspection selection acknowledge. The sensor sets its outputs in order to represent the MSB (Most Significant Bits) of the binary coding of the Inspection selection number, where output 1 represents the LSB of the first 3 bits and output 3 represents the MSB of the first three bits.

Example:

- Inspection number, binary coded, is represented by 6 bits: **b1 b2 b3 b4 b5 b6**. In **phase 7** only MSB are sent: **b1, b2, b3**.
- Acknowledge bits, phase 6: **output1=b3, output2=b2, output3=b1**.

 **Note:** a timeout T2 will end phase 7 if no Trigger Input signal is received after phase 6 within 4 seconds. If T2 occurs the Inspection selection will be ignored and the sensor will resume the previous running Inspection.

Phase 8: Trigger Inputs HIGH: PLC ACKNOWLEDGE. All sensor outputs HIGH.

The third Trigger Inputs pulse after phase 5 represents the PLC acknowledge and the END of the protocol. After MIN_PULSE_DUR time interval from the instant when the sensor has received the third Trigger Input pulse all sensor outputs are set to HIGH, representing the END of the process. The sensor will keep outputs HIGH until the Inspection loading has finished; after the Inspection has successfully been loaded all sensor outputs are set to LOW.

 **Note:** a timeout T2 will end phase 8 if no Trigger Input signal is received after phase 7 within 4 seconds. If T2 occurs the Inspection selection will be ignored and the sensor will resume the previous running Inspection.

 **Note:** the Inspection loading time can vary depending on the Controls included in the Inspection to be loaded. In the worst case the loading process can take 600ms; this case is represented by n Inspection containing of 25 Geometric Pattern Match tools.

Protocol Selection

To enable expert protocol select Advanced Inspection Switching Protocol. Adjust Minimum Pulse Duration value according to pulses duration your SVS will receive. Press TEACH button to save your configuration.

6.6.3. Digital Teach In

Digital Teach In function consists in sending to the sensor a digital pulse on PIN 1. The digital pulse must have a minimum duration specified through the Minimum Pulse Duration slider available inside Input pin setup menu: all pulses having a duration higher than the minimum expected are accepted by the sensor.

After receiving the Teach In request on PIN 1 the sensor will grab a new Reference Image and perform a new Teach phase on the current running Inspection.

Note: the sensor will not send any acknowledge to the digital Teach In request.

To enable digital Teach In function through just select one of the following options from Input Pin setup menu:

- Tach: only digital teach in will be enabled.
- Advanced Inspection Selection Protocol + Teach: both digital teach In and Advanced Inspection Switching Protocol will be enabled. In this way the digital Teach In request corresponds to an Inspection Selection request where the slot number of the selected Inspection is the current running one.

6.7. Password



In the password menu the user can set a password to protect the system. This protects the sensor against accidental or unauthorised modifications. The password is disabled by default. To set a new password, use the **ARROW** buttons to select *Enable* and then press **SET** to confirm.



It is now possible to enter a new password consisting in a sequence of four buttons on the keyboard. Once the password has been entered, press **SET** to confirm. The password status switches from *Disabled* to *Enabled*.



When the password is enabled, the user can perform either of the following operations:

- Modify the password:**
 To modify the current password, select the *Modify* option and then press **SET** to confirm. The device will request the user to enter the current password first. Once the old password has been entered, a new one can be entered too.



- Disabling the password**
 To disable the password option, select the *Disable* option and then press **SET** to confirm. The device will request the user to enter the current password enabled. Enter the password and press **SET**. The password status switches from *Enabled* to *Disabled*.



NOTE: when the password is *Enabled*, everytime the user tries to leave the monitor mode, the device requests to enter the current password. Once entered the password, the user can go to the other configuration panels in which it is possible to change the parameter settings.

After 5 minutes without changes, the device goes back to monitor mode and it enables the password again.

If the password is lost, insert the unlock code **STATUS - STATUS - STATUS - STATUS - TEACH - TEACH - TEACH - STATUS - STATUS - TEACH**. This sequence will unlock the sensor and disable the password.

7. CONTROLS

7.1. Remarks

These controls play a key role in the inspection process: they are used to perform controls/checks and measurement on acquired images. Entering the controls is an operating step of the inspection.

The controls are the tools used to establish the inspection specifications

In its most basic version, the inspection process may be simplified as follows:

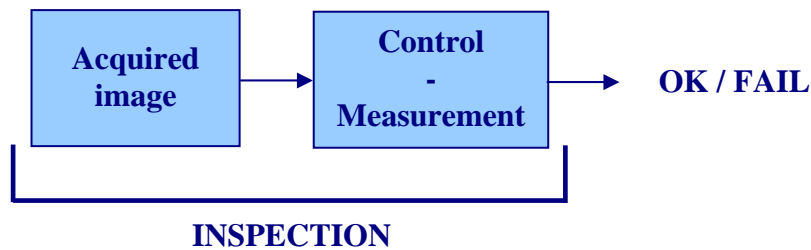

and consists in acquisition and one single measurement/control, which will return a certain result.

The controls use an absolute reference system, with the origin located in the top left corner of the work area.



Each inspection tool is analysed below, highlighting the:

- **Description:** control functions
- **Selection:** indication of the menu from which it can be selected
- **Positioning:** ROI positioning and resizing procedures
- **Parameters:** description of the configuration parameters
- **Result:** description of the achieved result
- **Example:** here is a complete example, from selection, to configuration, to output configuration



NOTE: an application can often be resolved using different logic patterns and therefore different controls. There is however an inspection tool which is more performing than the others. It is therefore recommended to carefully choose the control tool and perform a series of tests on the same application.

7.2. Brightness

- **Description**

The term brightness means the "brightness" attribute of an image.

Once the ROI has been set, the control will calculate the average brightness value of the pixels.

- **Selection**

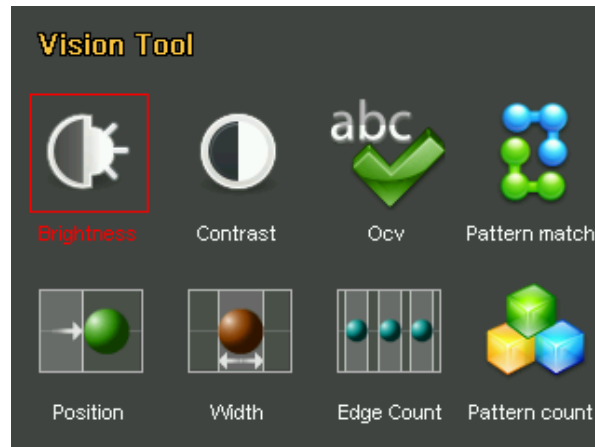

- **Positioning**

Select the control and press **SET** on the corresponding icon to create the rectangular ROI in the middle of the field range.



To modify the position of the ROI, move to the *Move ROI* icon and then press **SET**. It is now possible to move the ROI using the **ARROW** buttons. Once you have achieved the desired position, press the **TEACH** button to return to the Setup menu. If you wish to modify the ROI size, select the *Resize ROI* from the Setup menu (using the **SET** button again). It is now possible to increase or decrease the ROI size using the **ARROW** buttons.

- **Parameters:**

Expected

This indicates the expected brightness value, that is the threshold on which the inspection result is assessed.

- **Result**

If the average brightness value inside the ROI is above the set threshold, the result will be positive (green colour indicator and ROI edge) if it is below the threshold, the result will be negative (red colour indicator and ROI edge)

- **Example**

We would like to add the "Brightness" test to the current inspection to check for the presence of magnetic strips on badges.

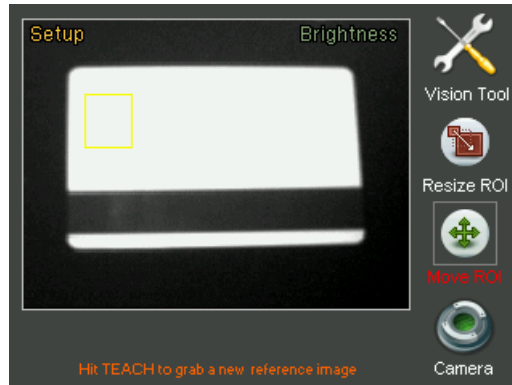

Select "Brightness" from the Controls menu and press **SET**.

First of all let's resize and position the ROI along the magnetic strip: Follow the instructions provided earlier during this procedure.



Let's now invert the grey colour scale. This means the magnetic strip will appear white, and the rest of the badge will be black. To do this, enter the camera setting control panel and enable the Negative option.

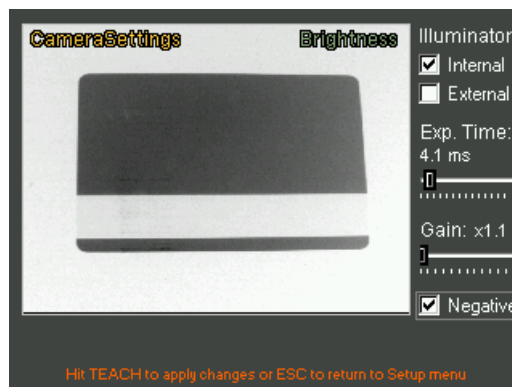

We can access the Adjust mode by pressing the **STATUS** button. Let's increase the acceptance threshold slightly using the **ARROW UP** button.

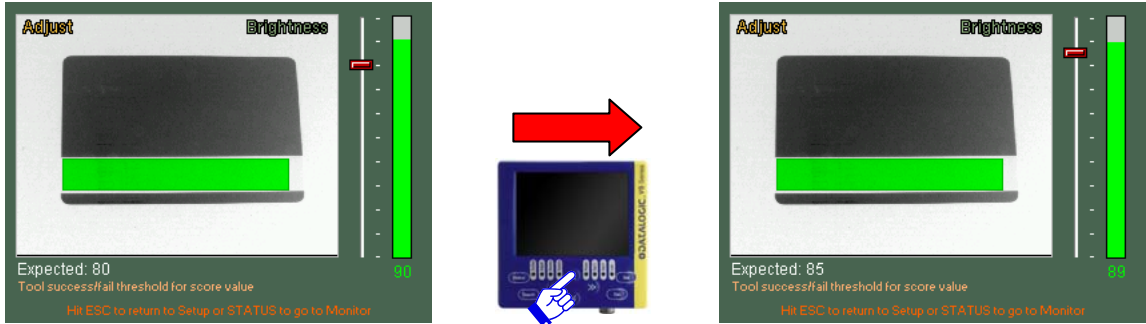

Now press the **STATUS** button to enter Monitor Mode and check that the tool functions properly. As the result is satisfying, press **STATUS** again and move on to defining the behaviour of the outputs.

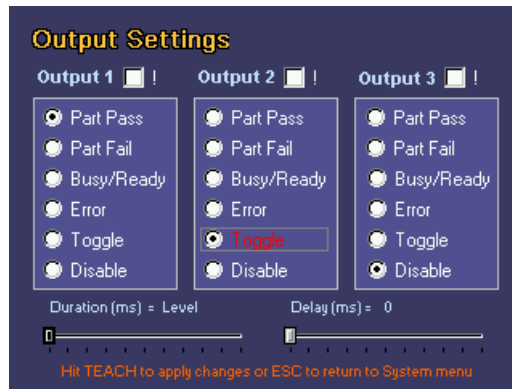

Let's associate output 1 to the Part Pass behaviour and output 2 to the Toggle behaviour (leaving output 3 disabled). Press **TEACH** to save the modifications.

Now let's save the bank on the sensor. Enter the Bankset menu and save the inspection in memory bank 1.

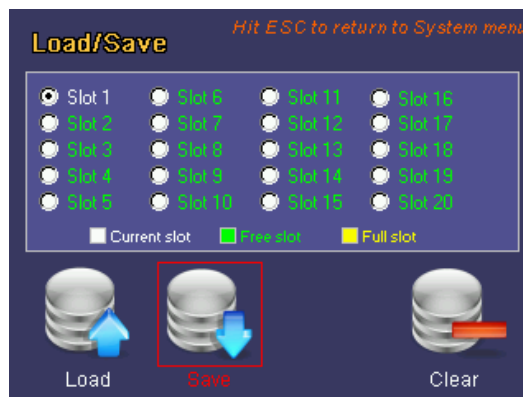

Press the **ESC** button to return to Monitor mode.

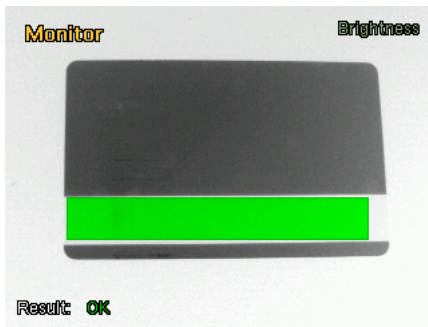

7.3. Contrast

- **Description**

The term contrast indicates the ratio between the brightness of the lightest pixel and that of the darkest pixel in an image.

Images with excessively high contrast tend to have only black and white areas, whilst images with low contrast tend to look grey.

- **Selection**

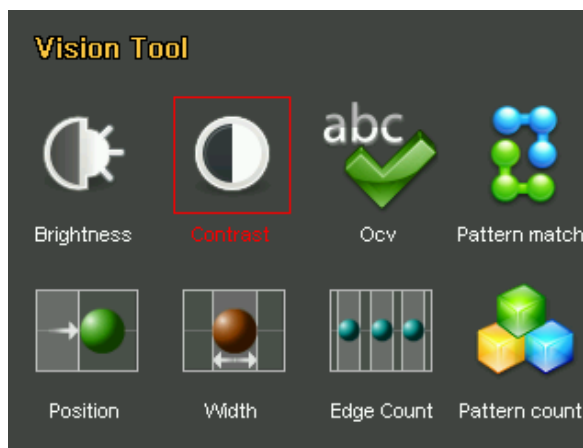

- **Positioning**

Select the control and press **SET** on the corresponding icon to create the rectangular ROI in the middle of the field range.



To modify the position of the ROI, move to the *Move ROI* icon and then press **SET**. It is now possible to move the ROI using the **ARROW** buttons. Once you have achieved the desired position, press the **TEACH** button to return to the Setup menu. If you wish to modify the ROI size, select the *Resize ROI* from the Setup menu (using the **SET** button again). It is now possible to increase or decrease the ROI size using the **ARROW** buttons.

- **Parameters:**

-

- Expected

This indicates the expected contrast value, that is the threshold on which the inspection result is assessed.

- Sensitivity

This modifies the sensor contrast sensitivity. In practice, if the sensitivity parameter is increased, the calculated contrast value will also increase.

- **Result**

If the pattern identified has a score not below the one set by the user through the Expected setting, the inspection result will be positive. If it is not so, outcome will be negative.

- **Example:**

We would like to add the contrast test to the current inspection to check the presence of post office stamps on envelopes.

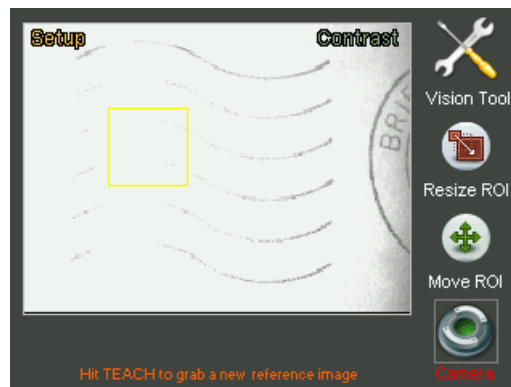

*Let's select "Contrast" from the Controls menu and then press the **SET** button.*

First of all let's adjust the camera settings. The image is in fact overexposed and the stamp is lacking in contrast.

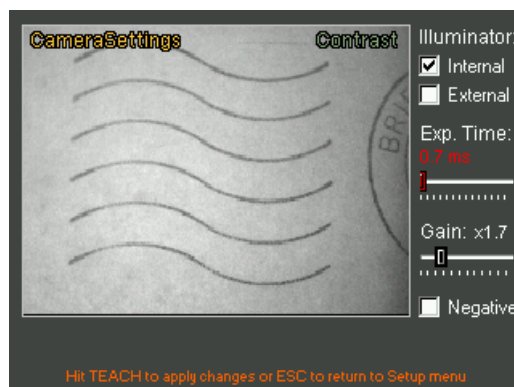

The image is now acceptable, so we must resize and position the ROI accordingly: follow the instructions provided previously during this procedure.

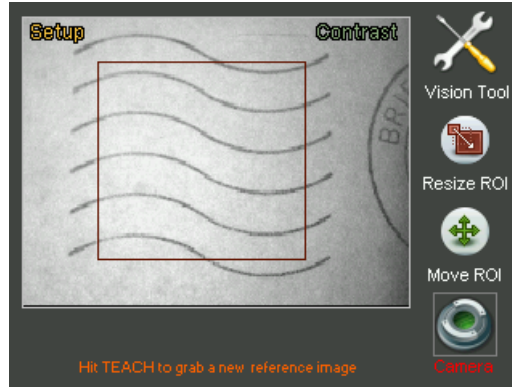

We can access the Adjust mode by pressing the **STATUS** button. If the control fails even when there is a stamp, increase the control sensitivity a little to raise the contrast between the stamp and the envelope. To do this use the **RIGHT ARROW** to view the sensitivity setting and then use the **ARROW UP** button to increase the value.

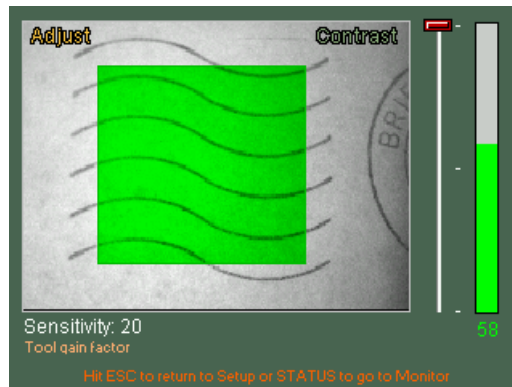
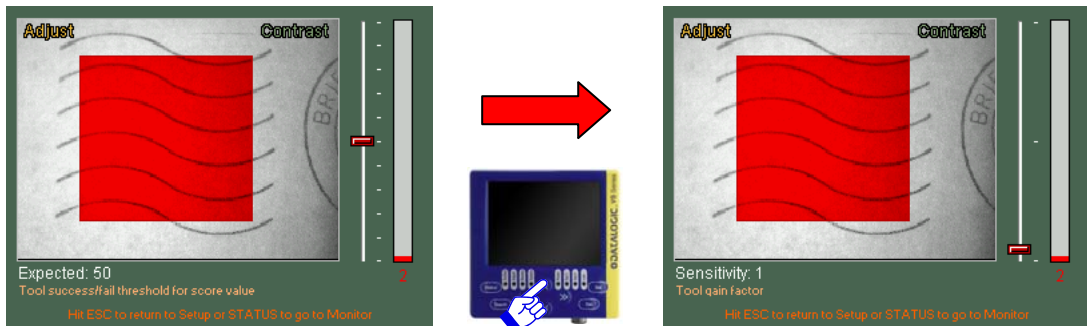

Now press the **STATUS** button to enter Monitor Mode and check that the tool functions properly.

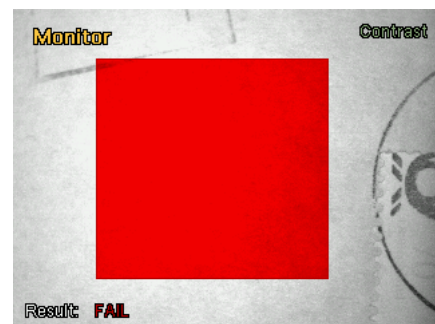
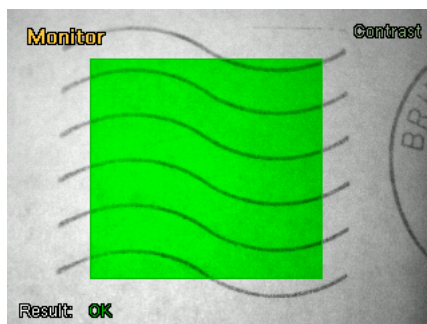

The sensor now behaves as required. As the result is satisfying, press **STATUS** again and move on to defining the behaviour of the outputs.

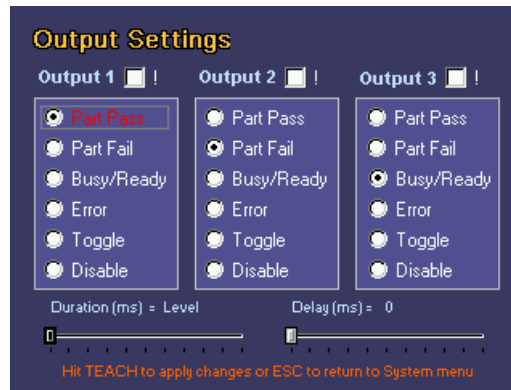

Let's associate output 1 to the Part Pass behaviour, output 2 to the Part Fail behaviour and output 3 Busy/Ready. Press **TEACH** to save the modifications.

Now let's save the bank on the sensor. Enter the Bankset menu and save the inspection in memory bank 1.

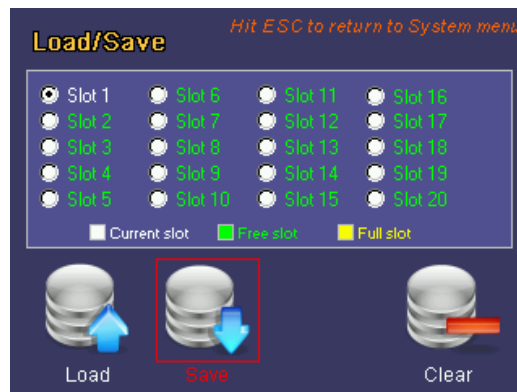

Press the **ESC** button to return to Monitor mode.

7.4. Position

- **Description**

This control allows you to detect the edge (edge detection ) and the position of the object inside the relative ROI.

Based on the first derivative of the pixel brightness variation function, the maximum positive peak is identified if control is targeting a positive edge, or the maximum negative peak is identified when targeting a negative edge. A point is considered an edge point when its brightness variation exceeds this threshold, which is a function of the peak value found.

- **Selection**

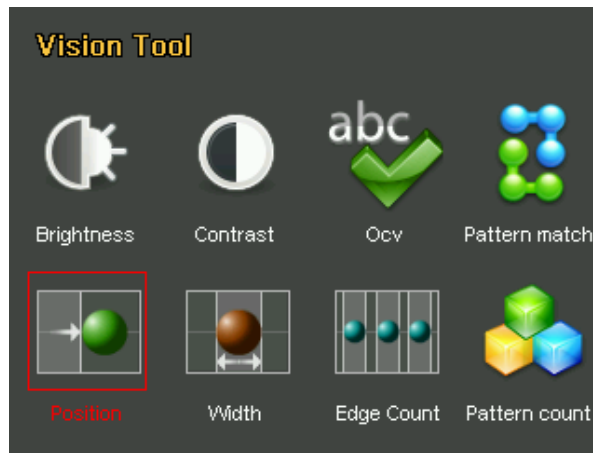

- **Positioning**

Select the control and press **SET** on the corresponding icon to create the rectangular ROI in the middle of the field range.



To modify the position of the ROI, move to the *Move ROI* icon and then press **SET**. It is now possible to move the ROI using the **ARROW** buttons. Once you have achieved the desired position, press the **TEACH** button to return to the Setup menu. If you wish to modify the ROI size, select the *Resize ROI* from the Setup menu (using the **SET** button again). It is now possible to increase or decrease the ROI size using the **ARROW** buttons.

- **Parameters:**
 - Min Position Expected
This allows you to specify the minimum value of the detectable position.
 - Max. Position Expected
This allows you to specify the maximum value of the detectable position.
- Sensitivity
This represents the sensitivity level, that is the level of edge detection precision. Set sensitivity affects processing results; the lower the sensitivity, the greater the accuracy.
- Variation type
This establishes how the edge is to be detected during image acquisition. Possible values are:
 - From white to black: an edge feature is detected when it changes from white to black;
 - From black to white: an edge feature is detected when it changes from black to white;
 - Both: a feature is indicated as an edge feature when it changes from white to black and black to white;
 - Automatic: the system automatically detects the edge feature.
- Noise reject
This is used to reduce noise during the edge detection process. It establishes the minimum variation in brightness of a feature in order for it to be considered an edge.
- Direction
This determines the direction and edge detection path inside the ROI. This can be one of four values:
 - From left to right (default value);
 - From right to left;
 - From top to bottom;
 - From bottom to top.
- **Result**
If the detected edge value is between the minimum and maximum values set by the user, the control gives a positive result. If no edges are found, or their values are not within the thresholds, the result will be negative.
- **Example**
Let's add a "position" control to the current inspection tool, so we can check that a cap is inserted correctly on a detergent bottle.

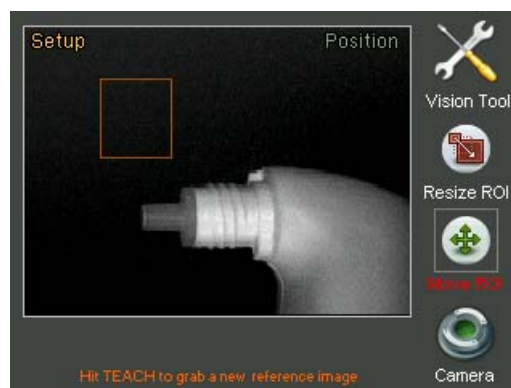

*Let's select "Position" from the Controls menu and then press the **SET** button.*

Now we must perform the ROI positioning and resizing procedures: follow the instructions provided earlier during this procedure.

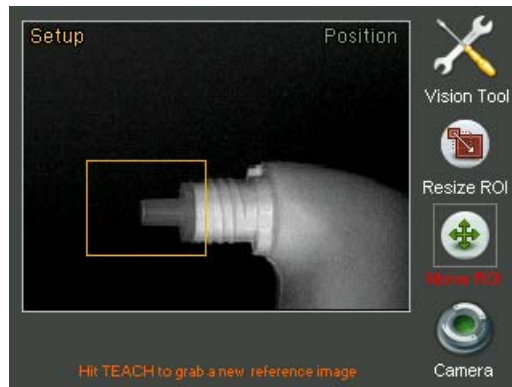

We can access the Adjust mode by pressing the **STATUS** button. Let's increase the minimum position value slightly using the **ARROW UP** button.

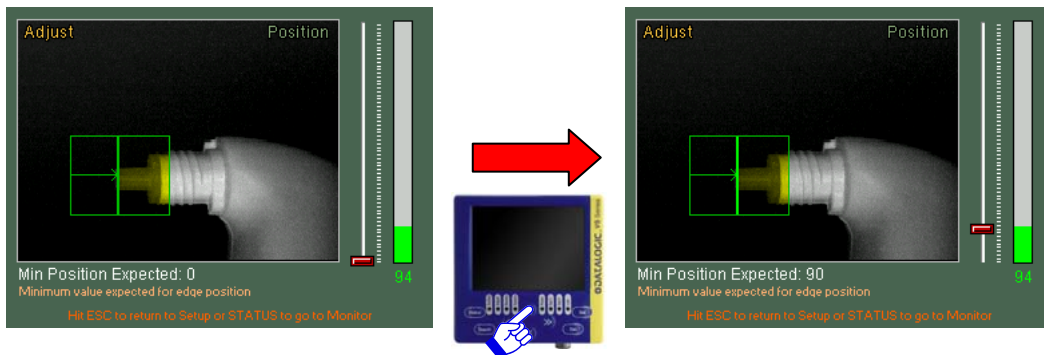

Now press the **STATUS** button to enter Monitor Mode and check that the tool functions properly.

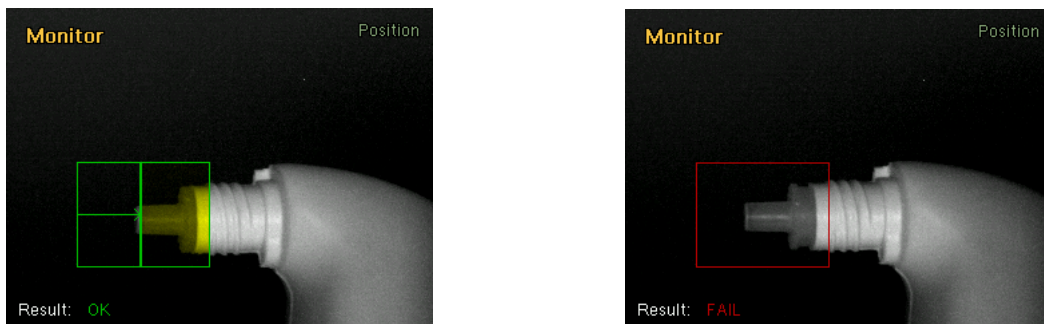

The sensor now behaves as required. As the result is satisfying, press **STATUS** again and move on to defining the behaviour of the outputs.

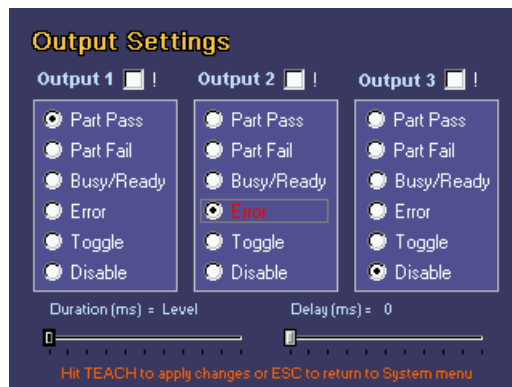

Let's associate output 1 to the Part Pass behaviour and output 2 to the Error behaviour. Press **TEACH** to save the modifications.

Now let's save the bank on the sensor. Enter the Bankset menu and save the inspection in memory bank 1.

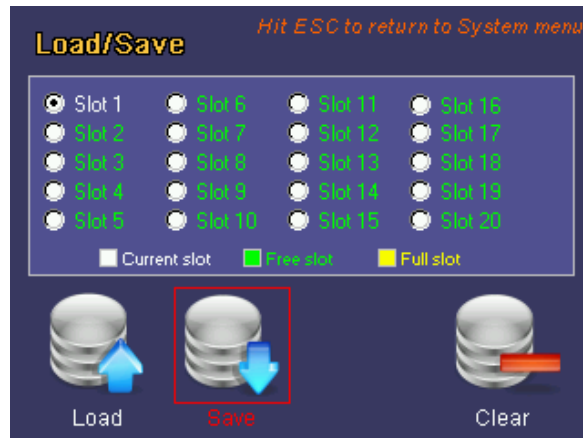

Press the **ESC** button to return to Monitor mode.

7.5. Width

- **Description**

This control is also termed "gauge" and lets you measure the distance between two points.

The edge detection techniques () are used to detect the edges of an object, and calculate the distance between the edges.

- **Selection**

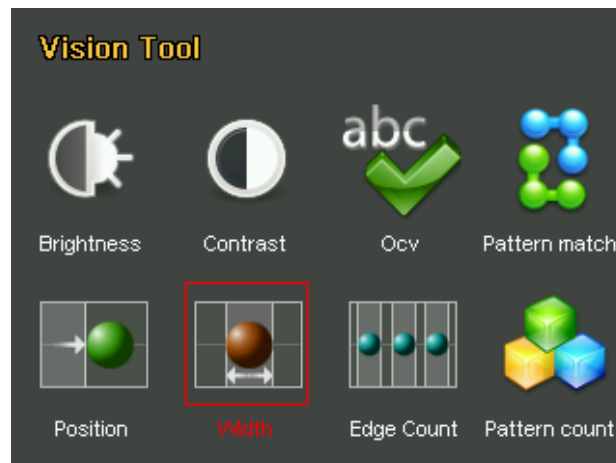

- **Positioning**

Select the control and press **SET** on the corresponding icon to create the rectangular ROI in the middle of the field range.



To modify the position of the ROI, move to the *Move ROI* icon and then press **SET**. It is now possible to move the ROI using the **ARROW** buttons. Once you have achieved the desired position, press the **TEACH** button to return to the Setup menu. If you wish to modify the ROI size, select the *Resize ROI* from the Setup menu (using the **SET** button again). It is now possible to increase or decrease the ROI size using the **ARROW** buttons.

- **Parameters:**

- Min Width Expected

- This indicates the minimum width threshold required to accept the inspected detail

- Max. Width Expected

- This indicates the maximum width threshold required to accept the inspected detail

- Sensitivity

Based on the first derivative of the pixel brightness variation function, the maximum positive peak is identified if control is targeting a positive edge, or the maximum negative peak is identified when targeting a negative edge. An edge feature is detected if the change in brightness is above the set threshold, expressed according to the detected peak value.

- Variation type

It is possible to define the methods used to detect the edges. Possible values are:

- From white to black: an edge feature is detected when a variation from white to black is detected;
- From black to white: an edge feature is detected when a variation from black to white is detected;
- Both: a feature is indicated as an edge feature when it changes from white to black and black to white;
- Automatic: the system automatically detects the edge features.

- Noise reject

This is used to reduce noise during the edge detection process. The threshold refers to the value of the first derivative: it establishes the minimum variation in brightness of a feature in order for it to be considered an edge.

- Direction

This determines the search direction of edges inside the ROI. This can be one of two values:

- Horizontal (default value)
- Vertical

- Measure type

This defines the direction when searching for edges to calculate the distance. Can be selected:

- Internal: The search starts from the centre towards the outside
- External: The search starts from the outside towards the centre

- **Result**

If the calculated width value is between the minimum and maximum values set by the user, the control gives a positive result. If no edges are found, or their reciprocal distances are not within the two defined limits, the result will be negative.

- **Example**

Let's add a "width" control to the current inspection tool, so we can check that a box is closed correctly.



Let's select "Width" from the Controls menu and then press the **SET** button.

The ROI must be resized and positioned as required: follow the instructions provided earlier during this procedure.



We can access the Adjust mode by pressing the **STATUS** button. Let's decrease the maximum width limit value slightly using the **ARROW DOWN** button. This has made the acceptance rules more severe. In fact we want to be certain that the width of the piece being inspected does not differ from the set standard value.

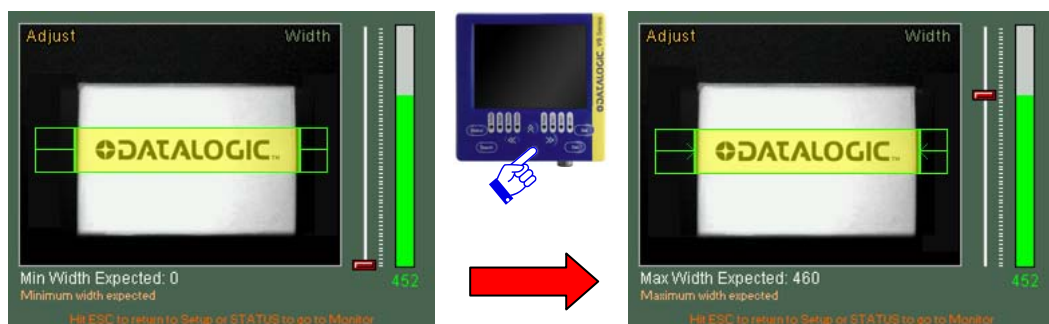

Now press the **STATUS** button to enter Monitor Mode and check that the tool functions properly.



The sensor now behaves as required. As the result is satisfying, press **STATUS** again and move on to defining the behaviour of the outputs.

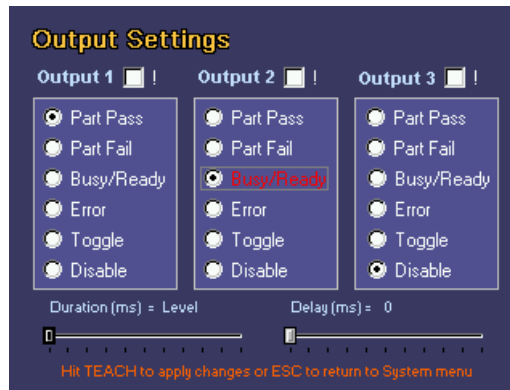

Let's associate output 1 to the Part Pass behaviour and output 2 to the Busy/Ready behaviour. Press **TEACH** to save the modifications.

Now let's save the bank on the sensor. Enter the Bankset menu and save the inspection in memory bank 1.

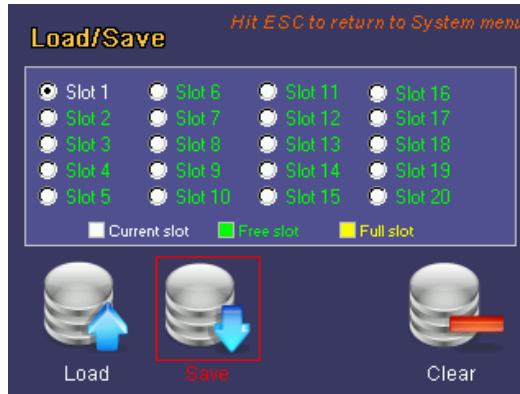

Press the **ESC** button to return to Monitor mode.

7.6. Edge count

- **Description**

This control allows you to detect all the edges (edge detection ) that are within a specific ROI. Based on the first derivative of the pixel brightness variation function, the maximum positive peak is identified if control is targeting a positive edge, or the maximum negative peak is identified when targeting a negative edge. A point is considered an edge point when its brightness variation exceeds this threshold, which is a function of the peak value found.

- **Selection**

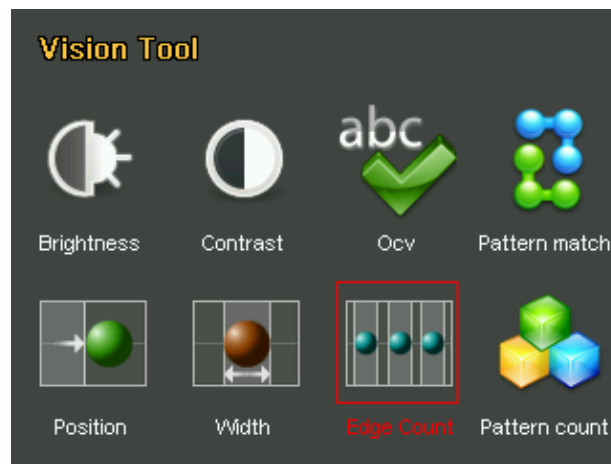

- **Positioning**

Select the control and press **SET** on the corresponding icon to create the rectangular ROI in the middle of the field range.



To modify the position of the ROI, move to the *Move ROI* icon and then press **SET**. It is now possible to move the ROI using the **ARROW** buttons. Once you have achieved the desired position, press the **TEACH** button to return to the Setup menu. If you wish to modify the ROI size, select the *Resize ROI* from the Setup menu (using the **SET** button again). It is now possible to increase or decrease the ROI size using the **ARROW** buttons.

- **Parameters:**

- Min edges Expected

- This allows you to specify the minimum number of detectable edges.

- Max. edges Expected

- This allows you to specify the maximum number of detectable edges.

- Sensitivity

- This represents the sensitivity level, that is the level of edge detection precision. Set sensitivity affects processing results; the lower the sensitivity, the greater the accuracy, hence, the more edges will be found.

- Variation type

- This establishes how the edge is to be detected during image acquisition. Possible values are:

- From white to black: an edge feature is detected when a variation from white to black is detected;
 - From black to white: an edge feature is detected when a variation from black to white is detected;
 - Both: a feature is indicated as an edge feature when it changes from white to black and black to white;
 - Automatic: the system automatically detects the edge features.

- Noise reject

- This is used to reduce noise during the edge detection process. The threshold is a function of the first derivative and establishes the minimum brightness variation for a point to be considered as an edge point;

- Direction

- This determines the direction and edge detection path inside the ROI. This can be one of four values:

- From left to right (default value);
 - From right to left;
 - From top to bottom;
 - From bottom to top.

- **Result**

- If the number of detected edges is between the minimum and maximum values set by the user, the control gives a positive result. On the contrary, the result will be negative.

- **Example**

- *Let's add a "count" control to the current inspection tool, so we can check that all three medicine phials are present.*

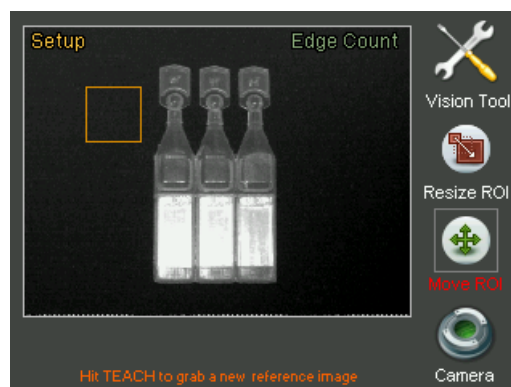

- *Let's select "Edge Count" from the Controls menu and then press the **SET** button.*

The ROI now has to be suitably resized and positioned: follow the instructions provided earlier during this procedure.

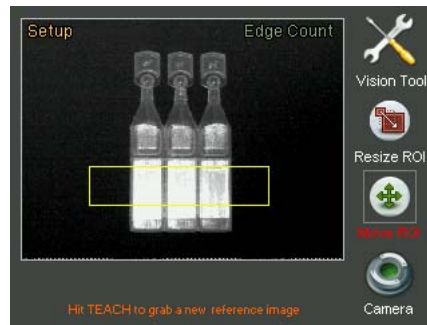

We access the Adjust mode by pressing the **STATUS** button. Let's increase the minimum edge limit value to 3 using the **ARROW UP** button.

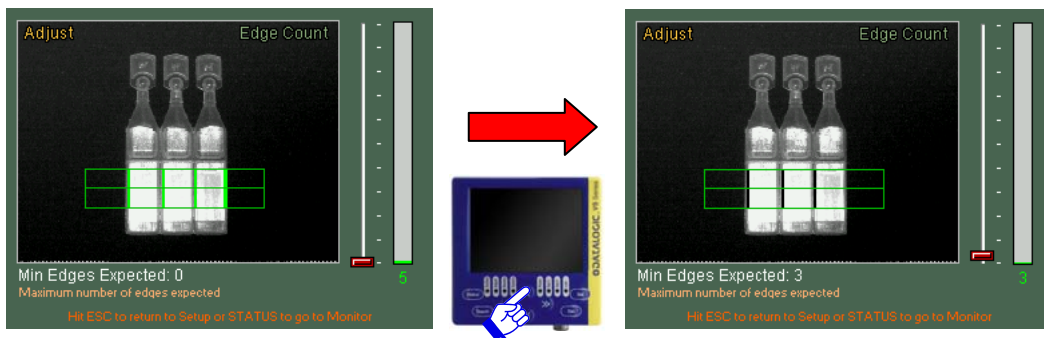

Use the **RIGHT ARROW** button to set the type of variation to be detected. Use the **ARROW UP** button to see the Black to White value.

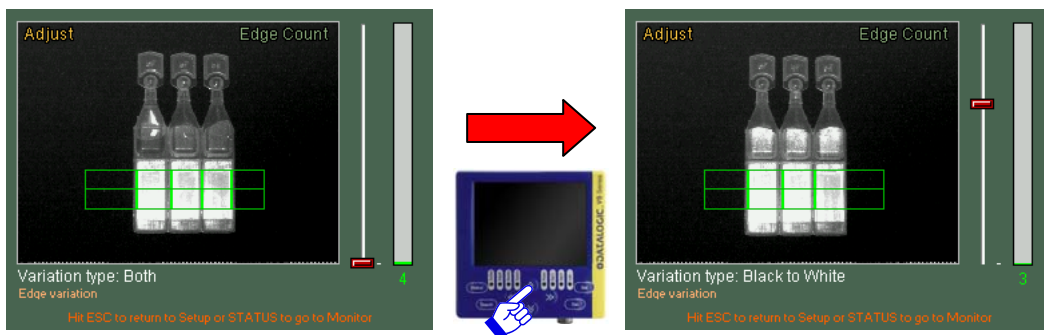

Now press the **STATUS** button to enter Monitor Mode and check that the tool functions properly.

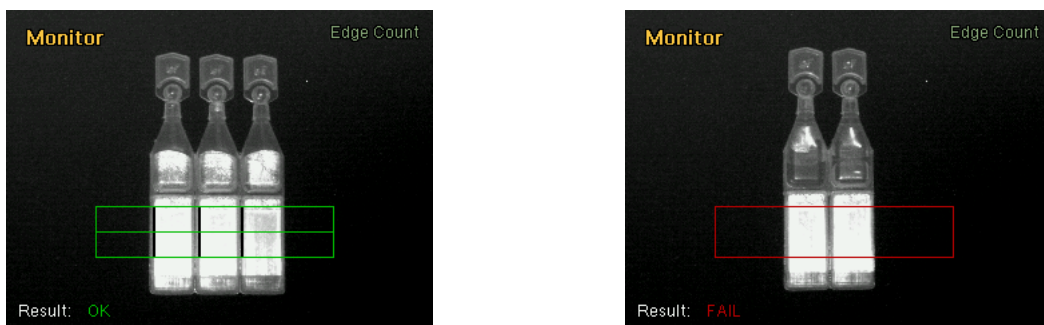

The sensor now behaves correctly. As the result is satisfying, press **STATUS** again and move on to defining the behaviour of the outputs.

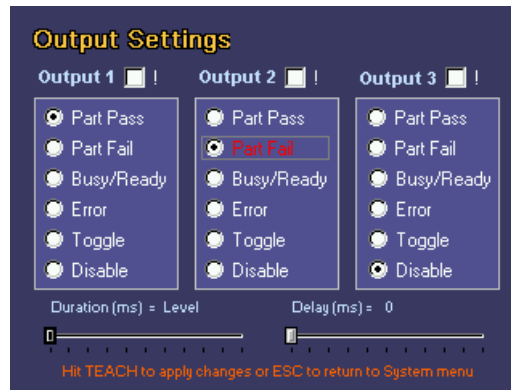

Let's associate output 1 to the Part Pass behaviour and output 2 to the Part Fail behaviour. Press **TEACH** to save the modifications.
 Now let's save the bank on the sensor. Enter the Bankset menu and save the inspection in memory bank 1.

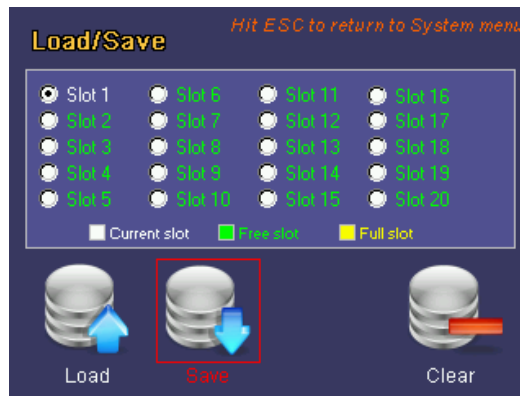

Press the **ESC** button to return to Monitor mode.

7.7. Pattern Match

- **Description**

The term pattern match signifies a process that searches for a pattern similar to the master image inside the target image using its brightness matrix. (Pattern Match )

Once the ROI has been set, the control calculates the edge points (features) that show significant differences in pixel brightness.



NOTE: the image used by the algorithm to perform the comparison used as the inspection base can be defined by the user in the Setup stage using the **TEACH** button. If the user moves on to the Adjust phase before setting any reference images, the inspection algorithm will use the first frame it acquires after the tool is selected. If you are not happy with the current choice, you can select a new reference image by returning to the Setup phase using the **ESC** button.

- Selection

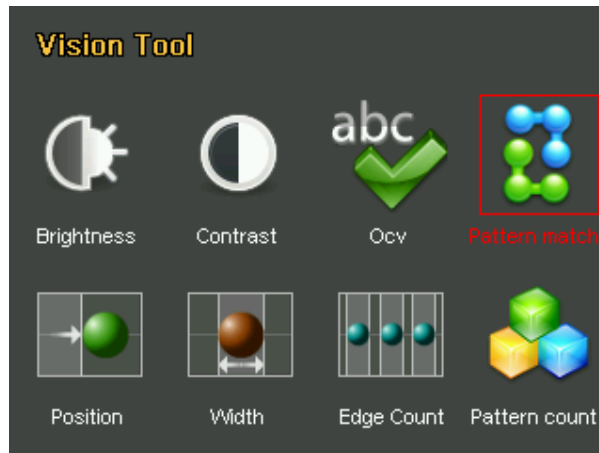

- Positioning

The positioning and resizing of the ROI for the Pattern Match control is different compared to what we have seen for the other inspection tools. During the setup phase, it is in fact necessary to define the pattern to be searched inside the image and also the section of the area which has to be searched.

Select the control by pressing **SET** on the corresponding icon to create two rectangular ROI: One, in the middle of the focus range, that represents the sample to be searched, the other is as large as the entire image and constitutes the pattern search area.

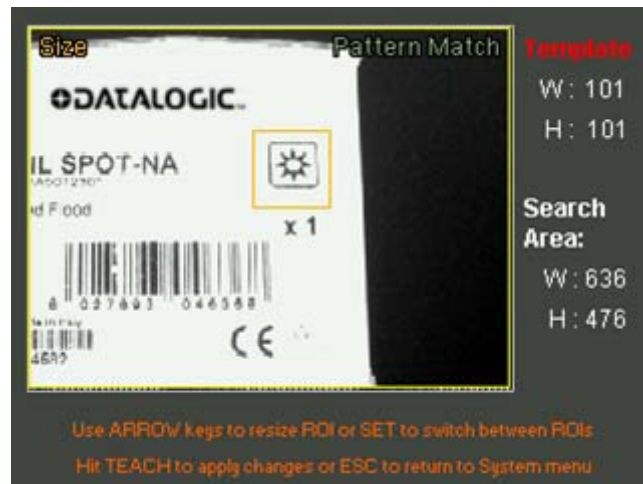

Press the **SET** button to modify one or the other area. The edge of the currently selected area will flash and the label of the ROI will be highlighted in red.

To modify the size of the two ROI, move the cursor to the *Size ROI* icon and then press **SET**. It is now possible to resize the ROI using the **ARROW** buttons. The sizes of two areas (expressed in pixels) are displayed on the right side of the screen. Press the **SET** button to modify one or the other area. The edge of the currently selected area will flash. Once you have achieved the desired resizing, press the **TEACH** button to return to the Setup menu. If you wish to modify the ROI positions, select the *Move ROI* from the Setup menu (using the **SET** button again). It is now possible to move the ROI using the **ARROW** buttons on the keyboard. Once again, to change the current ROI simply press the **SET** button. To conclude, press **TEACH** to save the modifications.

- **Parameters**

- Expected

- Threshold used to assess the result. This indicates to what extent the detected area in the ROI must match the sample image in order to be considered as valid (100% perfect match, 0% ...).

- **Sensitivity**

- This identifies the accuracy with which the pattern is searched inside the acquired image. The higher the desired quality, the more time is required to complete the processing. Vice-versa, the faster the processing must be, the lower the match quality will be.

- **Result**

- If the number of detected patterns is between the minimum and maximum values set by the user, the control gives a positive result. On the contrary, the result will be negative.

- **Example:**

- Let's add a "pattern match" control to the current inspection tool, so we can check that there is a logo on each box.*



*Let's select "Pattern Match" from the Controls menu and then press the **SET** button.*

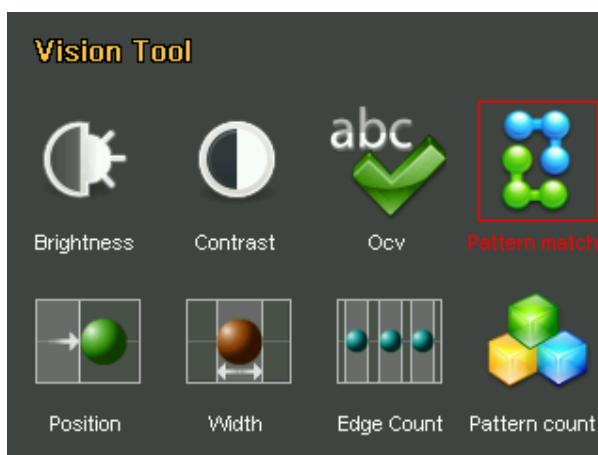

*A rectangular default ROI will appear in the centre of the image
The ROI must be resized and positioned as required: follow the instructions provided earlier during this procedure.*

We now go to Adjust mode by pressing the **STATUS** button. Let's increase the expected value slightly using the **ARROW UP** button as we want exact replicas of the original logo.

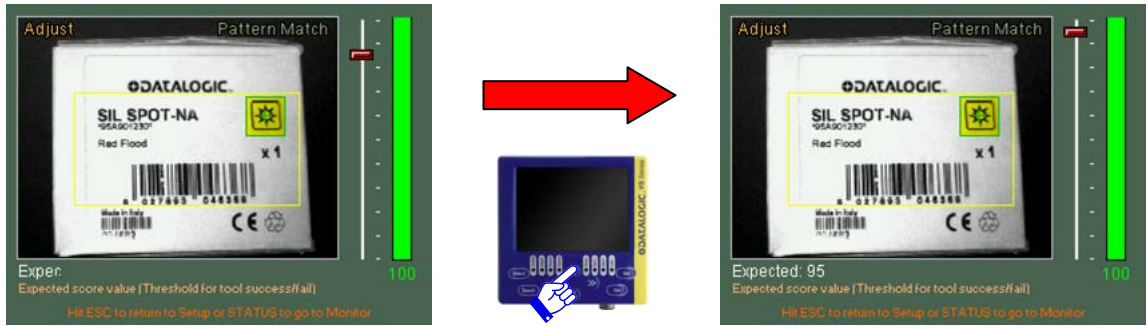

Now press the **STATUS** button to enter Monitor Mode and check that the tool functions properly.



The sensor now behaves correctly. As the result is satisfying, press **STATUS** again and move on to defining the behaviour of the outputs. Let's associate output 1 to the Part OK behaviour and output 2 to the Part Fail behaviour. Press **TEACH** to save the modifications.

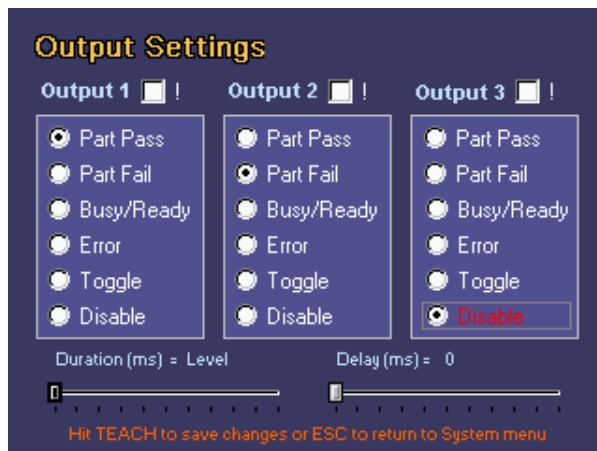

Now let's save the bank on the sensor. Enter the Bankset menu and save the inspection in memory bank 1.

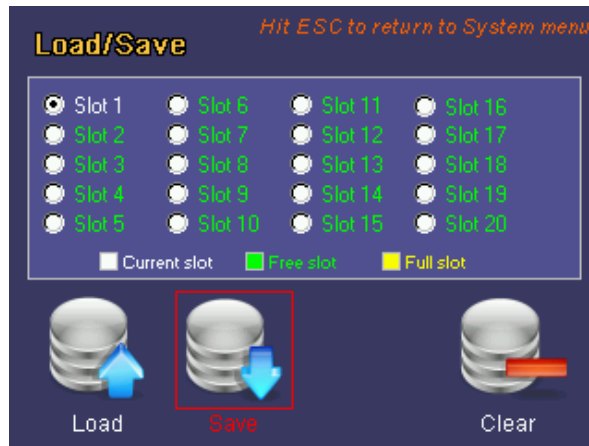

Press the **ESC** button to return to Monitor mode.

7.8. OCV

- **Description**

The OCV (Optical Character Verification) operator is able to check whether the text contained in an image is identical to that in the reference image.

This control is not able to interpret the text it reads or send it to output. It simply checks that the detected string is identical to the reference sample.



NOTE: the image used by the algorithm to perform the comparison used as the inspection base can be defined by the user in the Setup stage using the **TEACH** button. If the user moves on to the Adjust phase before setting any reference images, the inspection algorithm will use the first frame it acquires after the tool is selected. If you are not happy with the current choice, you can select a new reference image by returning to the Setup phase using the **ESC** button.

- **Selection**

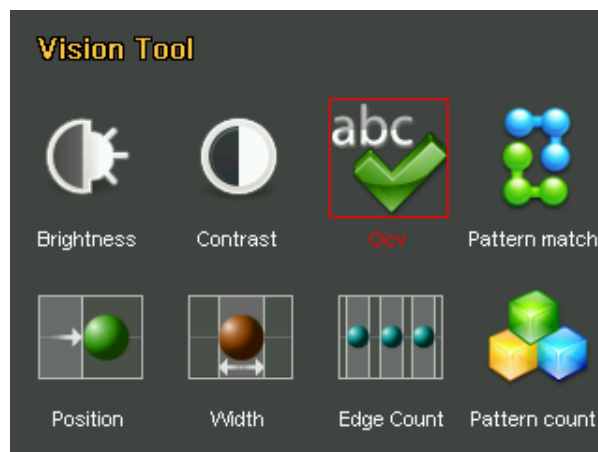

- **Positioning**

Select the control and press **SET** on the corresponding icon to create the rectangular ROI in the middle of the field range.



To modify the position of the ROI, move to the *Move ROI* icon and then press **SET**. It is now possible to move the ROI using the **ARROW** buttons. Once you have achieved the desired position, press the **TEACH** button to return to the Setup menu. If you wish to modify the ROI size, select the *Resize ROI* from the Setup menu (using the **SET** button again). It is now possible to increase or decrease the ROI size using the **ARROW** buttons.

- **Parameters:**

- Expected

- Threshold used to assess the result. This indicates to what extent the detected string in the ROI must match the sample string in order to be considered as valid (100% perfect match, 0% ...).

- Pinning

- This allows to specify the pinning level of the characters to read. This parameter is very important since, if properly set, allows to verify also strongly pinned characters.

- **Img Contrast**

- This identifies the contrast between the writing and the background. This parameter affects the binarization (📖) of the image. It does not affect the result if the binarization is set on manual.

- **Font size**

- It allows the user to define the minimum dimension of the characters that have to be verified. So it is possible to exclude from the verification not interesting small characters.

- **Threshold type**

- It specifies the binarization (📖) criterion for the character detection. It can be set on automatic or manual.

- **Manual threshold**

- This allows to specify the greylevel that has to be used in order to binarize (📖) the image. It can assume values from 0 to 255. It does not affect the result of the algorithm if the binarization has been set on automatic.

- **Light type**

- It defines the lighting uniformity within the field of view. It affects the calculation of the best binarization (📖) threshold only if the threshold type is automatic.

- **Result**

- If the string read by the sensor is identical to the reference string, the control gives a positive result. On the contrary, the result will be negative.

- **Example**

Let's add an "OCV" control to the current inspection tool, so we can check that a web address is printed correctly on boxes.

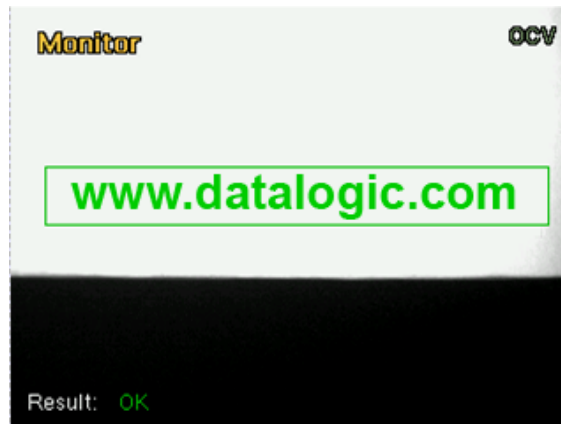

Let's select "OCV" from the Controls menu and then press the **SET** button.

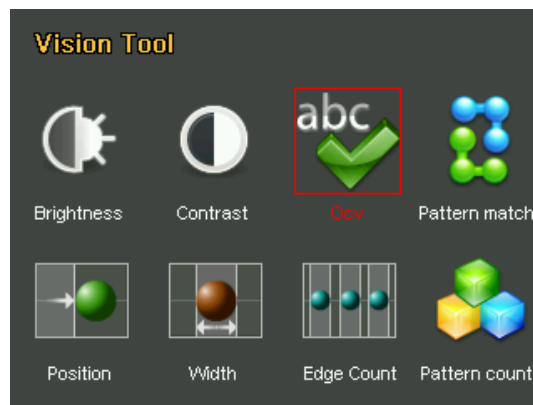

A rectangular default ROI will appear in the centre of the image. The ROI must be resized and positioned as required: follow the instructions provided earlier during this procedure.

We can access the Adjust mode by pressing the **STATUS** button. Let's increase the expected value slightly using the **ARROW UP** button as we want exact replicas of the original logo.

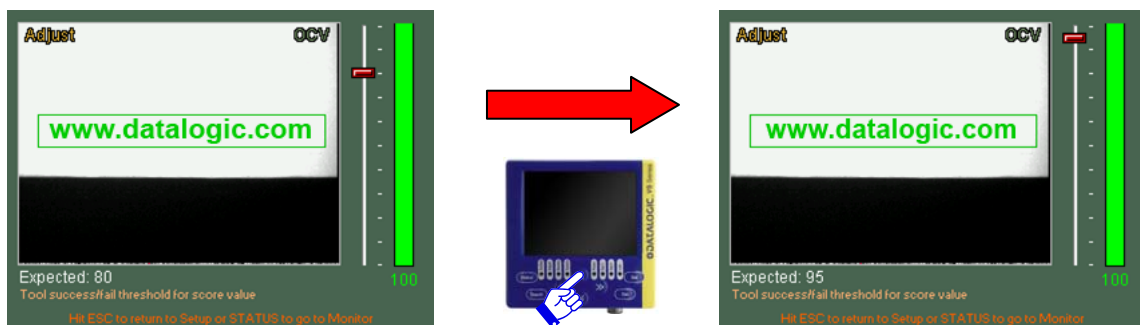

Now press the **STATUS** button to enter Monitor Mode and check that the tool functions properly.

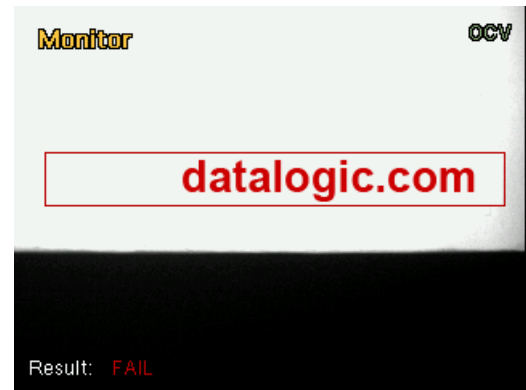
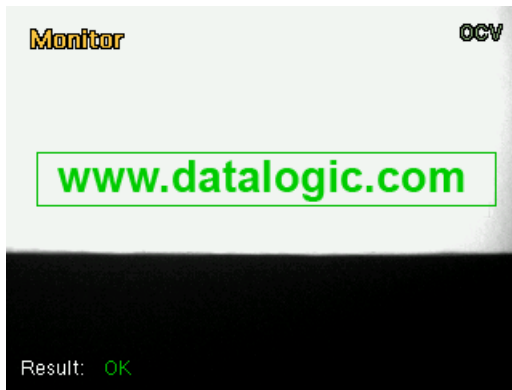

The sensor now behaves correctly. As the result is satisfying, press **STATUS** again and move on to defining the behaviour of the outputs. Let's associate output 1 to the Part Pass behaviour and output 2 to the Part Fail behaviour. Press **TEACH** to save the modifications.

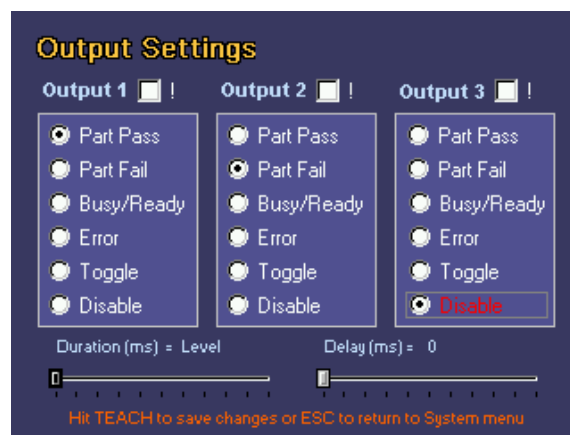

Now let's save the bank on the sensor. Enter the Bankset menu and save the inspection in memory bank 1.

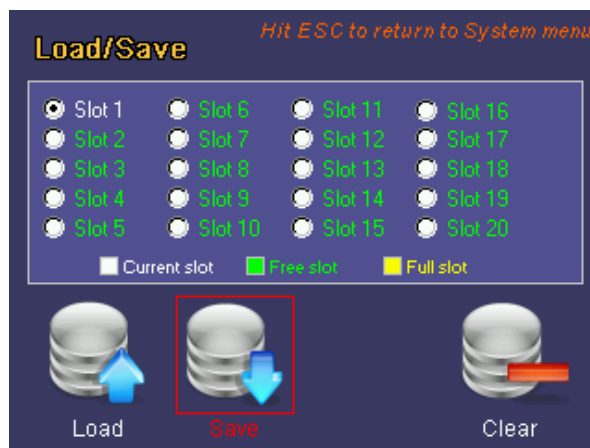

Press the **ESC** button to return to Monitor mode.

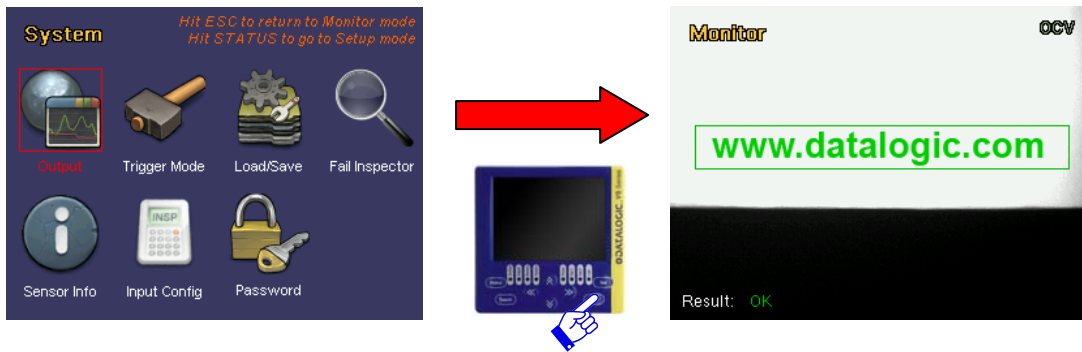

7.9. Pattern Count

• Description

The term pattern match indicates a process where sample image is recognised by searching for the matching brightness matrix in the target image. (Pattern Match )

Once ROI is fixed, the inspection looks for the target object within a specific area of the image and determines its position and number of matching objects found. It is hence possible to detect the horizontal traverse as well as the vertical shifting of the object within the inspection area.



NOTE: the image used by the algorithm to make the comparison for the inspection can be defined by user during the Setup stage, by pressing the **TEACH** button. If user moves on to the Adjust stage without setting any reference image, the inspection algorithm will use as reference the first frame captured after tool selection. If current selection is not suitable, a new reference can easily be set by going back to Setup stage (pressing **ESC**).

• Selection

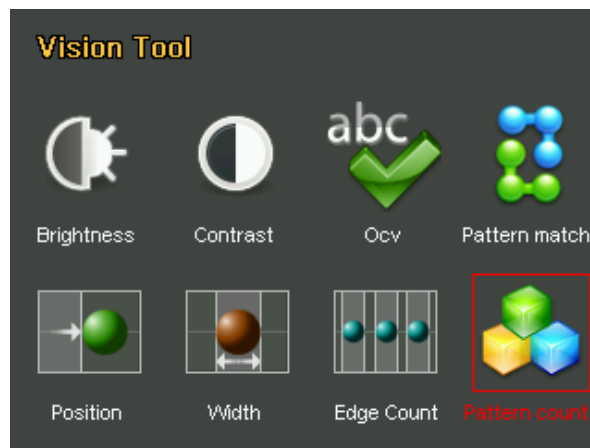

• Positioning

ROI position and resizing for Pattern Count inspection is different compared to the other inspection tools. During setup user shall define both the sample to be looked for within the image and the part of the area involved in the search.

Select this control by pressing **SET** button the relevant icon to create two rectangular ROIs: one at the center of the focus range, representing the sample to be searched for, and the other, as large as the whole image, which is the pattern search area.

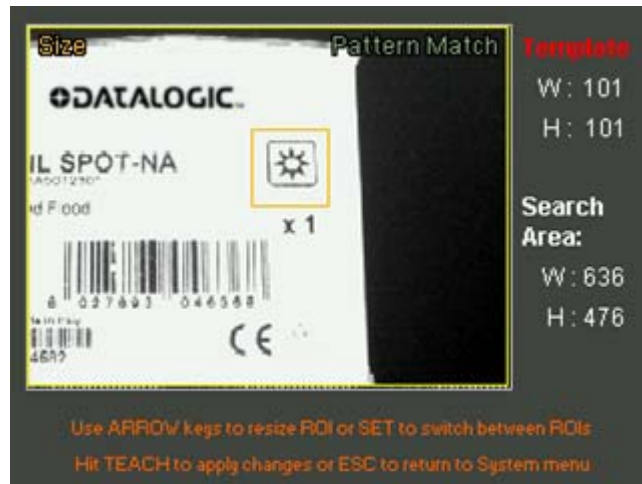

To swap from one area to the other for editing purposes, simply press **SET**. The outline of the currently selected area will flash and ROI label is highlighted in red.

To change the size of the two ROIs it is necessary to set onto *Size ROI* icon and press **SET**. It is now possible to resize the ROIs at will using the **ARROW** keys. The size of both areas, in pixels, are displayed on monitor right-hand side. To swap from one area to the other for editing purposes, simply press **SET**. The outline of the currently selected area will flash. Once required size is set, press **TEACH** to go back to Setup menu. While, to edit ROIs positions, select *Move ROI* option from the Setup menu (always use **SET** key). Now you can move the ROIs using the **ARROW** keys on the keypad. Again, to select another ROI you simply need to press **SET**. Press **TEACH** to save any changes.

- **Parameters**

- Expected

- Threshold for assessing the result. It indicates to what extent the area detected within the searched ROI must match the sample image in order to be considered valid (100% perfect match, 0% ...).

- Min Count

- Setting specifying the minimum number of patterns that can be detected.

- Max Count

- Setting specifying the maximum number of patterns that can be detected.

- **Sensitivity**

- Identifies the accuracy used when searching for the pattern inside the captured image. The higher the desired quality, the longer is the time required to complete image processing. Vice versa, the higher the desired speed, the lower the match quality.

- **Result**

- If the number of identified patterns falls within the range set by the user (min. and max. values), the inspection outcome will be positive. If it is not so, result will be negative.

- **Example**

- Say that we wish to add an inspection of the "pattern count" type to current inspection, so as to make sure that the logo is present on the box.*



Select "Pattern Count" from the controls menu and press **SET**.

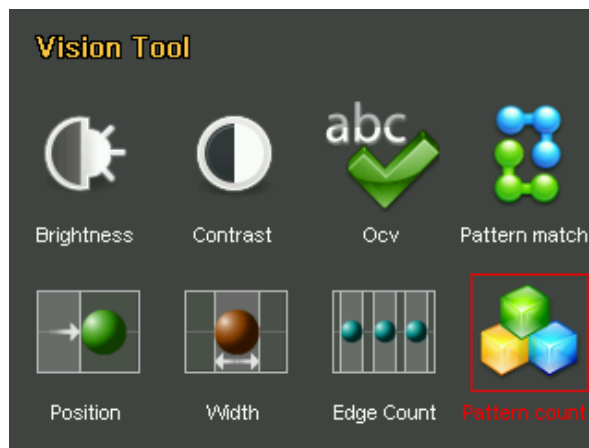

A rectangular default ROI shall be created at image center. The ROI shall then be sized and positioned as required: to do this, we use the above-described options.

Then set to Adjust mode pressing **STATUS**. Slightly increase expected value using the **ARROW UP** key because we wish to obtain exact copies of the original logo.

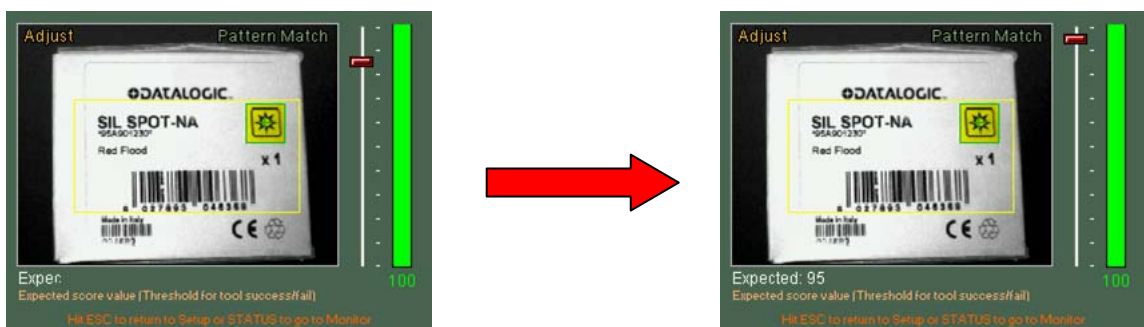

Press **STATUS** to toggle to Monitor mode to make sure the enabled tool is working correctly.



The sensor response is correct. Since the result is satisfactory, press again **STATUS** and set up the outputs. Assign Part OK to output 1 and Part Fail to output 2. Press **TEACH** to save edited settings.

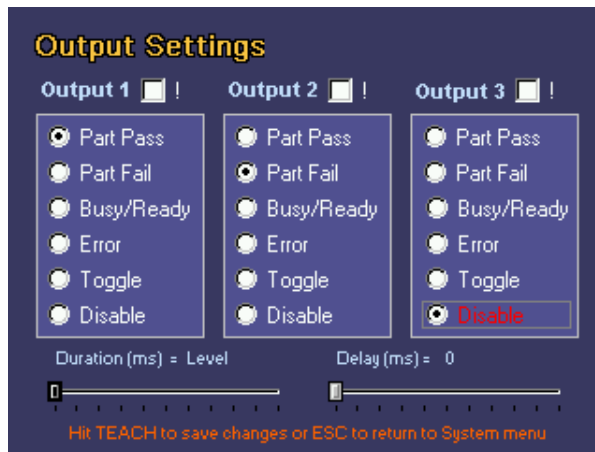

Now save the bankset to the sensor. Set to Bankset menu and save the inspection within memory area 1.

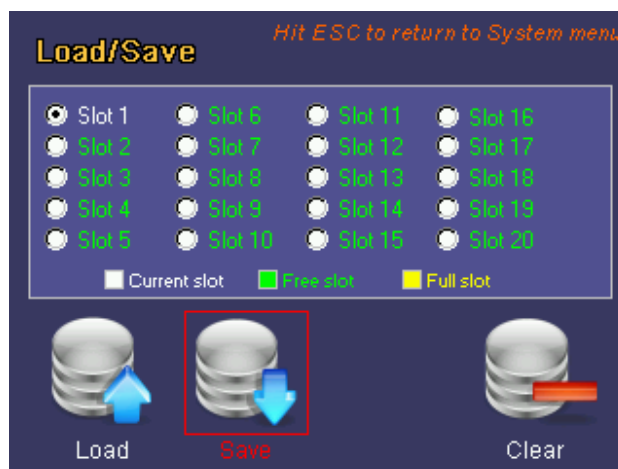

Then go back to Monitor mode by pressing **ESC**.

8. TEACH BUTTON



The Teach button located on the upper part of the sensor allows you to reboot the device in *Recovery* mode. This function is needed to update the firmware of the sensor.

To enable the recovery procedure, boot the device whilst holding the TEACH button down until the output LEDs (the two central ones) start to flash; this means the sensor is loading its recovery software.

Using the software supplied with the update kit, it is then possible to connect the sensor to the PC and enable the update procedure. Please refer to the manual supplied with the Kit for further details.

9. CHECKS AND PERIODIC MAINTENANCE

Correct maintenance consists in the removal of dust or foreign objects from the sensor.

Remove any dust build-up from sensor body using a soft cloth; if needed, dampen cloth slightly with a mild detergent solution.

To clean off dust and fingerprints from the lenses, use an anti-static compressed air can. Use a cloth and a specific lens detergent to remove any residue.

Avoid using:

- detergents which contain alcohol or solvents
- wool or synthetic cloths

Please refer to the Datalogic Automation website (www.automation.datalogic.com) to check for any new updates for the configuration software. To check the software version and date on your system, please access the System menu → Version.

10. WARRANTY

The product you purchased is warranted to be free from manufacturing defects for a period of 36 (thirty-six) months from date of manufacture.

Warranty does not cover damage and defects resulting from improper use of the sensor or accidental damage due to shock or in the event the product is dropped.

The sensor contains cutting-edge electronic components that cannot be repaired or replaced by the final user. Do not dismantle the device or make any changes to its components or the warranty will become null and void.

Datalogic may not be held liable for damage to persons or property resulting from failure to comply with the provisions reported herein.

In the event of problems, contact the after sales /repair service of DATALOGIC AUTOMATION.

Service Department

Tel.: +39 051 6765611

Fax.: +39 051 6759324

11. TECHNICAL DATA

DataVS1	
Supply voltage:	24 Vdc \pm 10%
Ripple voltage:	1 Vpp max with illuminator 2 Vpp max without illuminator
Consumption (DataVS1 + VSC): <i>(excluding output current and illuminator)</i>	210 mA @ 24 Vdc
Current consumption with illuminator: <i>(depends on how long illuminator stays on)</i>	280 mA @ 24 Vdc
Outputs:	3 PNP outputs (short circuit protection)
VSC connection:	M12 8 pole A-code
Interface for external illuminator:	Strobe Signal (24 V PNP N.O.)
Output current:	100 mA max
Output saturation voltage:	< 2 V
Optics:	Integrate
Resolution:	640 \times 480 (VGA)
Indicators:	4 LEDs + 3.5" colour LCD monitor
Settings:	VSC Configurator
Data retention:	Non volatile FLASH memory
Operating temperature:	-10 $^{\circ}$ C ... +55 $^{\circ}$ C
Storage temperature:	-25 $^{\circ}$ C ... +75 $^{\circ}$ C
Vibrations:	Width 0.5 mm, frequency 10 ... 55 Hz, For each axis (EN60068-2-6)
Shock resistance:	11 ms (30 G) 6 shocks for each axis (EN60068-2-27)
Housing material:	Aluminium alloy / ABS
Mechanical protection:	IP50
Connections:	2 x M12 8 pole A-code
Weight:	125 g (DataVS1); 170 g (VSC)

IMAGE SENSOR

Technology:	CMOS
Supply voltage:	3.3 V
Format:	$\frac{1}{3}$ -inch
Pixel matrix:	752 x 480
Pixel size:	6.0 μ m x 6.0 μ m
Maximum frame rate:	60 fps
SNR:	55 dB
Responsivity:	4.8 V/lux-sec

12. OVERALL DIMENSIONS

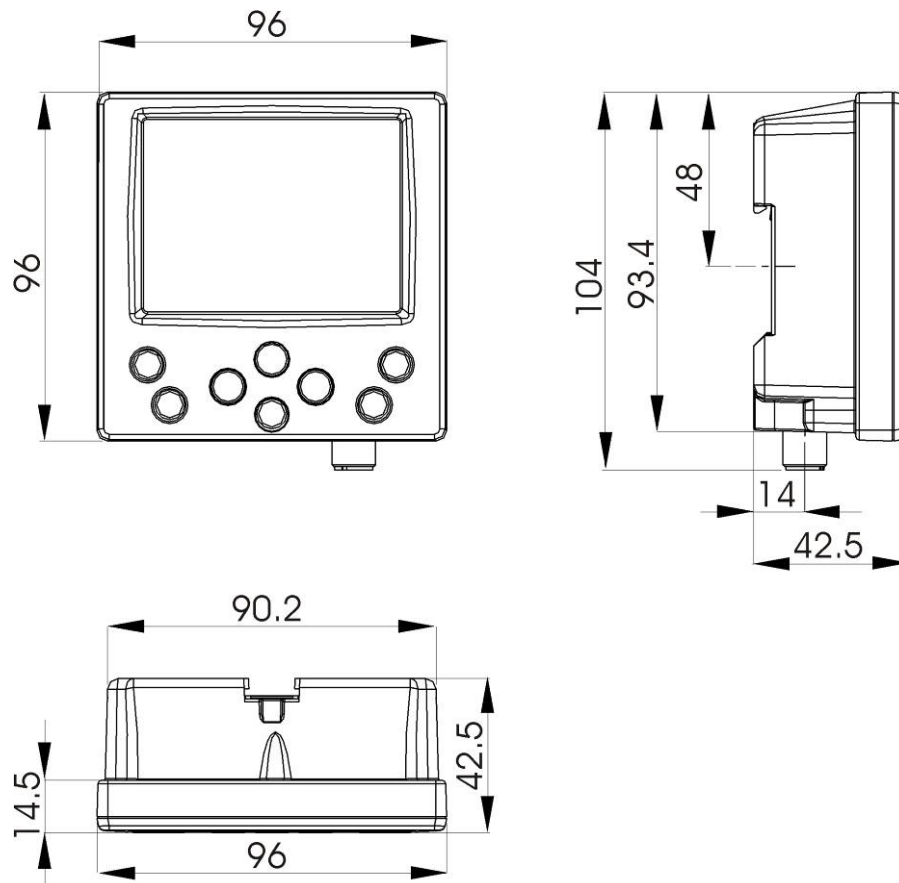
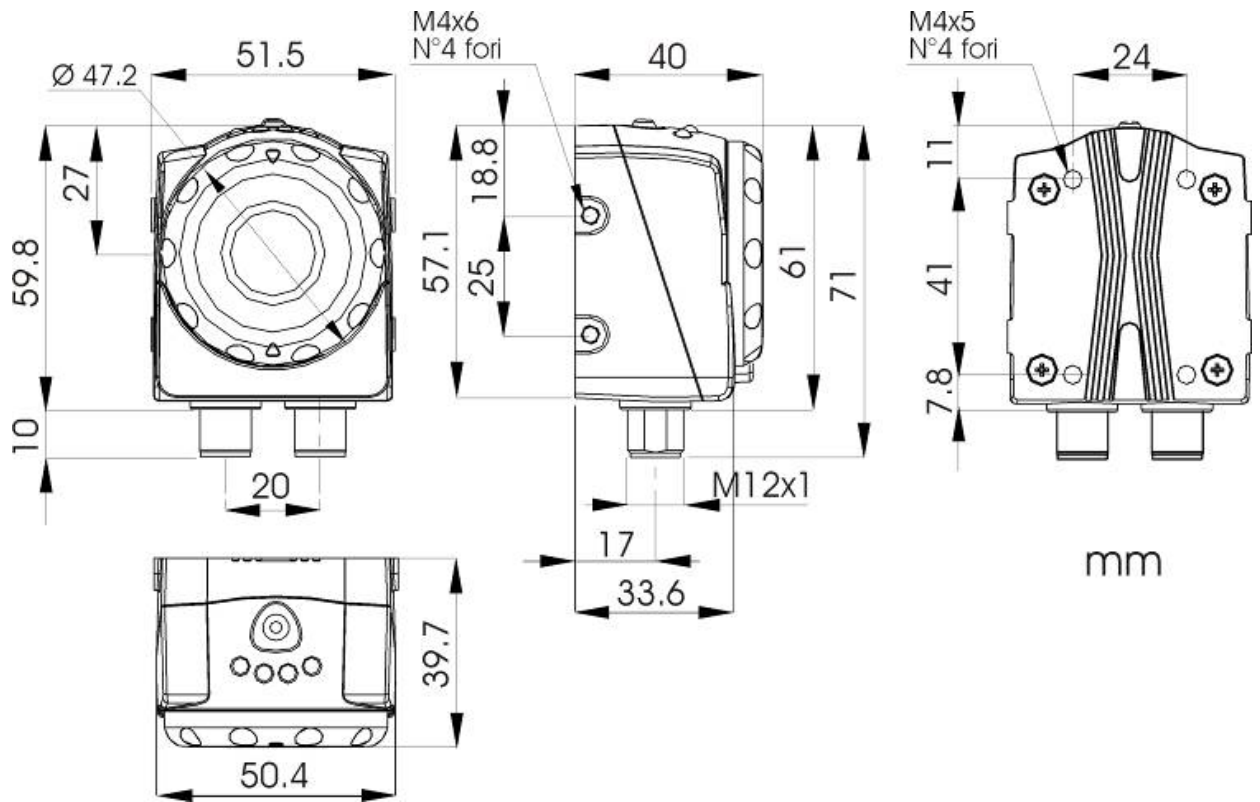

13. ACCESSORIES

ST-5066
U-shaped bracket to adjust the angle

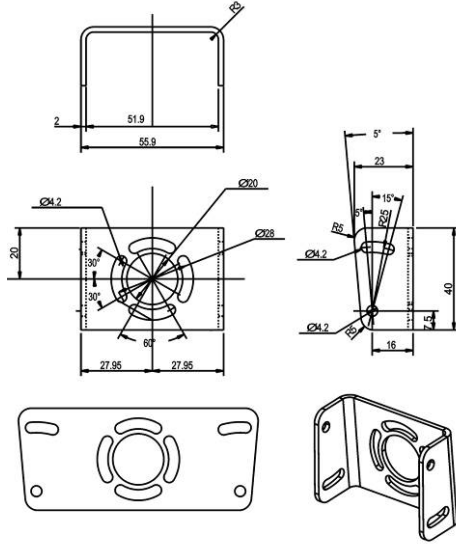

ST-5068
L-shaped bracket to fix the sensor at a 90° angle

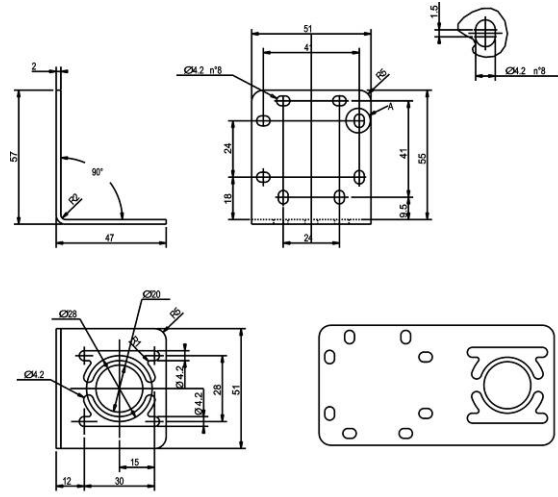

MOUNTING KIT

Base

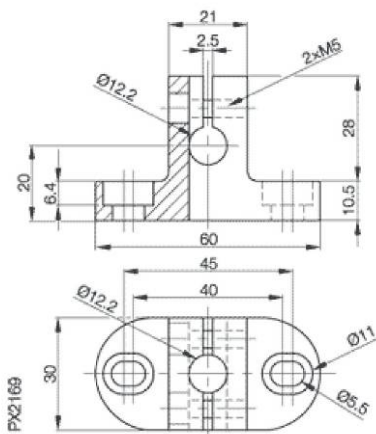

Pin

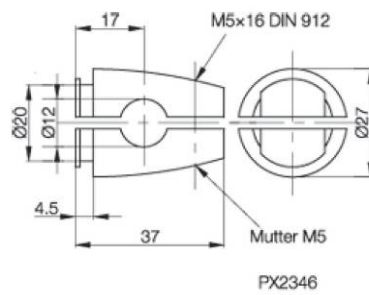

Arm

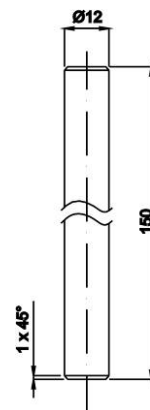

MODEL	DESCRIPTION	ORDER No.
CS-A1-06-B-03	M12 8-pole connector with 3 m unshielded cable	95ACC2230
CS-A1-06-B-05	M12 8-pole connector with 5 m unshielded cable	95ACC2240
CS-A1-06-B-10	M12 8-pole connector with 10 m unshielded cable	95ACC2250
DataVS1-VSC	VSC Configurator	959941040
SVS-CV-VSC-02	2m SVS-VSC connection cable	95A901360
SVS-CV-VSC-04	4m SVS-VSC connection cable	95A901370
DataVS1 UPDATING KIT	DataVS1 Updating Kit	95A901540
SVS-ST-5068	L-shaped fixing bracket for 90° mounting	95A901320
SVS-ST-5066	U-shaped fixing bracket for angle adjustment	95A901330
SVS-MK-01	Mounting kit	95A901380

14. TUTORIAL

14.1. Digital image

Digitisation allows real images acquired by a camera to be treated using a processor.

This is done in two steps:

- sampling: image is divided into a dot matrix. Dots are termed picture elements (or more commonly pixels);
- quantisation: each pixel is associated to a numeric value.

Such information may signify point brightness for grey scale images (0 = black, 255 = white), or three values (Red-Blue-Green, RGB coding) for colour images.

As a result, the real image is converted to a mathematical format (pixel matrix) which can be processed by a personal computer.

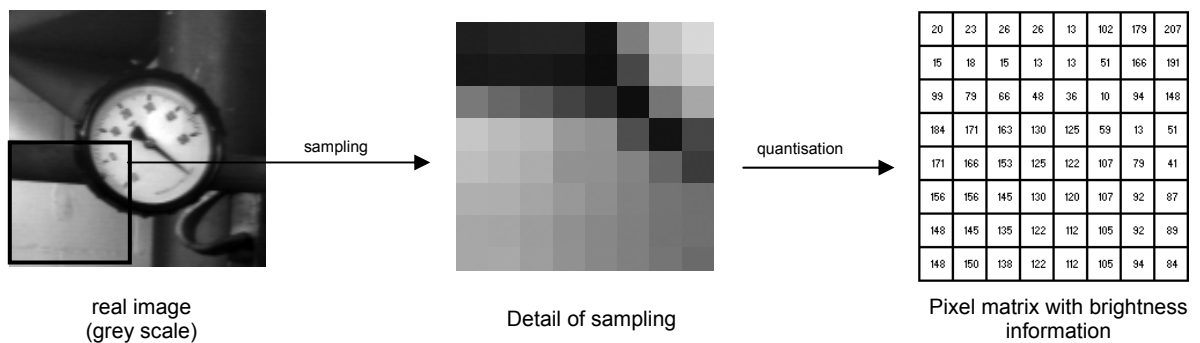

The maximum resolution of the DataVS1 sensor is 640 × 480 pixel. This means that the acquired images will be processed by a personal computer as 640×480 element matrixes (307200 values).

Each element is identified by its location in the matrix, i.e. by specifying column and line and considering the first element in the top left corner as the origin (in the matrix shown above, this would be the pixel with brightness equal to 20).

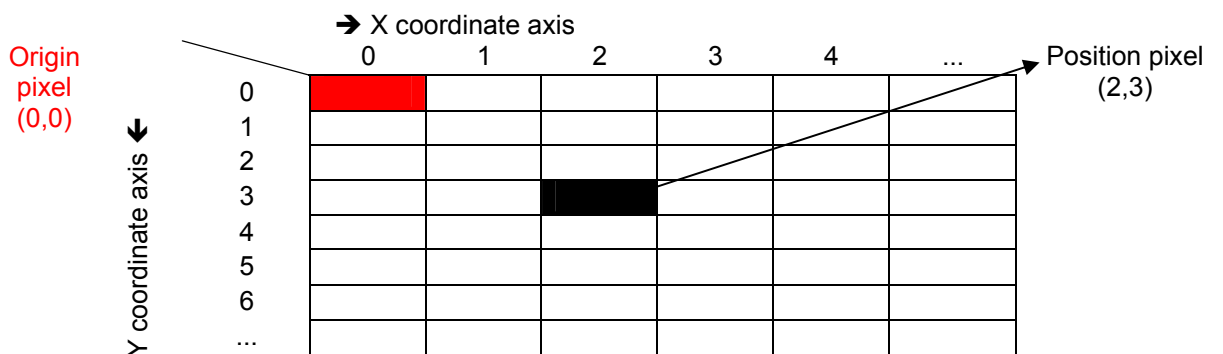

14.2. Machine vision

This is a specific branch of Computer Vision (or "artificial vision").

Computer vision is a generic concept which applies to all processes aimed at extracting information from images. On the other hand, machine vision has a specific purpose, i.e. control the operation of equipment and machinery in industrial applications (such as manufacturing lines or good handling applications).

In order to perform this task, machine vision equipment features stand-alone processing capabilities, digital inputs and outputs and dedicated peripherals such as photocells and/or a communication network that allows communication with other similar devices.

In the case of the DataVS1 system, the sensor "view" option allows you to inspect the product to:

- Check for missing or incomplete parts
- Conduct quality control procedures
- Take measurements

•

14.3. General comments on lighting

Lighting conditions are a critical aspect for the vision applications, therefore the settings must be correct and remain steady during processing.

This section provides some brief information on general lighting conditions, which can easily be found in the machine vision application.

- Keep the light level consistent in the area of interest
- The level of light must be as consistent as possible, try to avoid changes caused by external light sources (environmental illumination, sunlight). The disturbance caused by an external light source could cause the inspection to fail. The light produced by the internal illuminator may not be sufficient to eliminate the disturbance caused by other illumination, in this case it will be necessary to use an even brighter external illuminator or alternatively the area of inspection should be screened off.
- Keep the light level consistent in the area of interest
- Make sure that the area of interest receives even lighting, so there are no areas with shadows or others which are too bright. Also check that the objects are sufficiently illuminated and there is good contrast with the background. To this purpose, it is recommended to use an external illuminator when the distance between the sensor and the object to be detected is over 300 mm as the illuminator fitted on the sensor could be insufficient for longer distances.
- Position the lights in the correct position
Position the lights at the right distance from the objects and the sensor. Also check that the light source brightness is correct so that no areas of the area of interest are saturated.
- Lighting in the presence of reflecting surfaces
Experiments have proved that the SVS internal illuminator is not effective when the object has reflecting surfaces. A reflecting surface can cause saturation in some parts of the area of interest. In these cases the use of external light sources are highly recommended.

14.4. Lighting options

Ring light

This technique is suitable for a broad range of applications. The illuminator is mounted directly on the sensor and can illuminate any object placed in front of it. It provides diffused illumination over a small area.

- *Advantages:* It provides correct levels of illumination even for small sized objects. Reduces shadows caused by object projections. The illuminator mounted on the sensor ensures that light is focused on the inspection area.
- *Disadvantages:* In the case of large sized objects, there could be a drop in illumination along the edges which can create a shadow of dark pixels. High-reflectivity objects may generate a circular glare pattern that will alter the image to be captured. Possible applications are label date and code verification and label presence check.

Top light

This technique provides focused, extremely even illumination. The illuminator is positioned behind the sensor and when it is orientated correctly it provides extremely accurate inspections.

- *Advantages:* The light beam is offset compared to the sensor optics. This lets you enhance certain target areas.
- *Disadvantages:* It is quite complicated to illuminate the object evenly, especially when it has projections which can create shadows that can not be eliminated.

Back light

The illuminator is placed behind the target object, right before the sensor. The object between illuminator and sensor prevents part of the light from reaching the lens and creates a silhouette effect. The silhouette may be inspected to check dimensions and shape. Light intensity is low.

- *Advantages:* The acquired image is not affected by the surface features of the object. Facilitates the measurement of round object diameters. Detects the presence/absence of holes.
- *Disadvantages:* It may be physically complicated to position the illuminator behind the object. Object surface cannot be inspected; light source must be larger than inspected area.

Backlighting is typically used to sort objects by shape and size, measure gaps between a chip pins, inspect objects for holes or cracks.

14.5. Binarization

This is a process that converts any given image to a two-level image (in our instance, black and white). Conversion is based on a threshold that classifies the individual pixels as "level 255" (or "white") or "level 0" (or "black") depending on whether they are above or below set threshold. Let us consider a shot of a dark object on a bright background. Binarisation is expressed as follows:

$$B(i, j) = \begin{cases} 0 & \text{if } I(i, j) < S \\ 255 & \text{if } I(i, j) > S \end{cases}$$

In other words, the pixel with coordinates (i,j) of the source image I will be coloured black in the binarised image B if its (brightness) value is found to be below the threshold S, or will be coloured white if its value is above the threshold.

The purpose of this operation is to highlight just the key features of the image to minimise the computational load associated with its analysis.

The critical issue in this process is how to select the threshold S.

Let us consider a histogram of a grey scale image (representing the number of pixels as a function of brightness value)

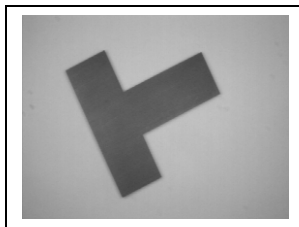

grey scale image

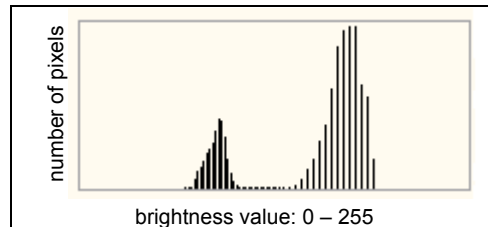

image histogram

As you can see, the brightness values of image pixels are clustered around two values ("bimodal" histogram): a low value that represents dark points (the object) and a high value that represents bright points (the background).

The most effective value is found mid-way between the two (128). This will turn out a binarised image where the object is neatly and accurately represented. With a lower threshold (90), part of the object would be treated as background; a higher threshold (175) would cause part of the background to be classified as object

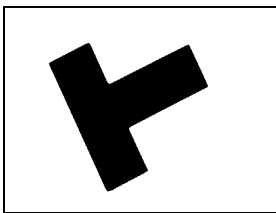

Image binarised with S = 128

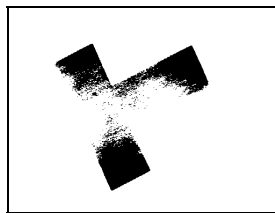

Image binarised with S = 90

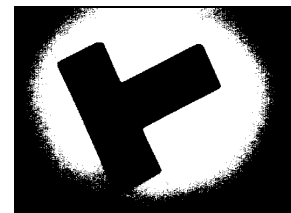

Image binarised with S = 175

Obviously enough, an image where object and background are not clearly differentiated (similar brightness values) will turn out a histogram with all pixels clustered around one value, and setting the appropriate threshold will prove quite difficult.

14.6.  Edge / Edge Detection

The term "edge" signifies the contour of the object shown in an image.

From an operational viewpoint, what happens is that the system detects the difference in the brightness of adjacent pixels compared to a certain threshold value. This variation on the DataVS1 system is detected along a direction:

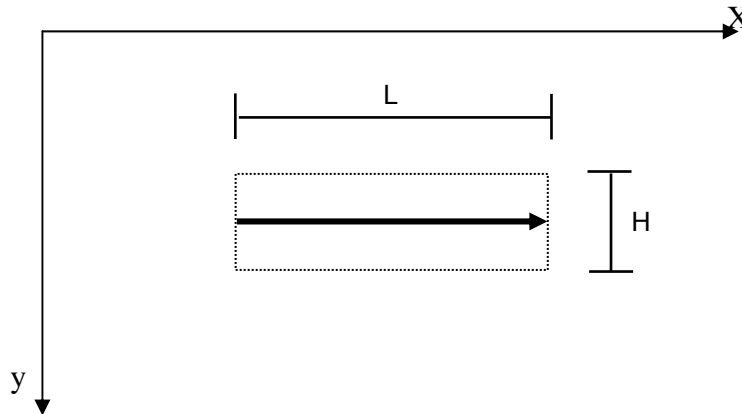

Let us consider the portion of image inside the rectangle that contains the plotted arrow (length L and height H): this area can be represented by a matrix of values that represent the brightness of the individual pixels

	85	98	120	128	135
	81	88	102	118	129
	87	101	119	128	136
total of column divided by 3	84	96	114	125	133

Each average value contains the information relating to a group of pixels and allows more accurate analysis.

At this point, edge identification may rely on threshold value or contrast.

Edge identification based on threshold

This is a simple, fast method that simply involves setting a numeric threshold. The edge is identified when the values associated with adjacent pixels encountered in the direction of the arrow are found to lie on different sides of the threshold (one above and the other below the threshold or vice versa, depending on whether target edges are negative or positive.)

The weakness of this method lies in the fact that effective edge identification requires guaranteed steady lighting.

Identification based on contrast

Edges are not detected directly based on pixel brightness, but rather using the first derivative of brightness trend.

This method is based on the search for maximum and minimum values of the function:

- A maximum value will identify a positive edge
- A minimum value will identify a negative edge

This way, detection is not sensitive to brightness, because while a variation in brightness does somehow affect the image in terms of pixel brightness, the differences between pixels are virtually unchanged. This method is ideal for those application where steady lighting is not guaranteed.

On the other hand, it involves greater computational load and longer processing times.

14.7. Inspection times

Total inspection duration depends on three factors:

- Exposure time ()
- Acquisition time
- Processing time

Exposure time: time period during which the acquisition device is exposed to light. The longer the exposure time, the greater the quantity of light entering the device. The duration of this time period is determined by:

- Speed of the parts to be inspected: the higher the speed, the lower the exposure time must be to avoid getting blurred images
- Inspection rate: this is a constraint for the exposure time, which must be low to guarantee a high number of inspected objects
- Available light: the better the lighting conditions, the less problems there will be during acquisition due to low exposure values

Where reducing exposure time is a must, certain arrangements might help preserving the quality of acquired images:

- Increase the brightness in the area of inspection
- Increase the CMOS gain: the gain, which is the output/input ratio, in this case is intended as the increase in brightness, which can however lead to a decrease in the quality of the image
- Use lenses with variable openings: the larger the opening that allows the light to pass through the lens, the less "deep" the image will be (it may be difficult to focus on an object which is at a variable distance from the lens)

Acquisition time: time taken by the sensor to capture an image. After the CMOS has been exposed to light/image during the exposure time, the image must be transferred to device memory. It takes about 30 ms to transfer a complete image. This time is significantly reduced if only a part of the total image is acquired.

Processing time: time taken to process the acquired image. It depends on the operations and tools used for the inspection.

14.8. Pattern Match

In the pattern match method, a sample object is recognised by searching for the matching brightness matrix in the target image.

The system stores a "pattern" of the master image and tries to find that pattern in all inspected target images. During the search process, the pattern is made to slide over the image while brightness differences are calculated pixel by pixel. An object is recognised when the total calculated difference is below a preset threshold.

14.9. Exposure

Exposure time determines how long the image acquisition device must remain exposed to light.

Image quality depends on this parameter, that is determined based on:

- Lens aperture;
- Exposure.

The term Lens aperture denotes the ratio of lens length to lens width. A longer lens (where light travels a longer distance) will have a higher ratio and will provide less strength. Conversely, a shorter lens features a lower ratio (fast lens).

The term exposure time is also known as "shutter opening time" and is directly proportional to the quantity of light hitting the sensor: the greater the shutter opening time, the greater the quantity of light, hence the brighter the acquired image.

A fast lens allows for shorter exposure time.

This is because exposure is a combination of aperture and exposure time: as these are inversely proportional, doubling aperture allows for halved exposure time.

This determines *correct exposure*, which is the right quantity of light needed for details to be visible both in the dark and bright areas of the image.

Underexposure will result in crushed blacks, i.e. loss of detail.

Overexposure will produce blown-out areas (bright, pale and flat).

15. GLOSSARY

- **Algorithm:** a combination of instructions that lead to the solution of a problem through a series of steps;
- **Area of inspection:** this corresponds to the area of interest acquired by the sensor, or part of the same, which is then processed;
- **CMOS:** device that acquires the images. It consists of a set of photo-sensitive elements (→ pixels) arranged in a matrix that are exposed to light through a glass window on chip surface;
- **Focus distance:** distance between the rear nodal point of the lens (the point where the light beam leaves the rear part of the lens) and the sensor;
- **FOV:** abbreviation of Field Of View. This the area framed by the sensor;
- **Grey scale:** scale of values associated to the brightness of the pixels in an image. For an 8 bit image, there are 256 possible values (0 – 255, where '0' stands for black and '255' stands for white);
- **Inspection:** process where the sensor controls and measures the target image, providing an output result;
- **Inspection result:** this can be:
 - "OK", if the inspection was successful (all the controls/measurements gave a positive result)
 - "Failure", if the inspection was not successful or if the inspection was not concluded due to it not being possible to perform the control/measurement process;
- **LED:** abbreviation of Light Emitting Diode, a device that exploits the optical properties of certain semiconductor materials to produce photons from the recombination of electron-gap sets;
- **Noise:** insignificant data that alter the sources of information to be processed;
- **Operating distance:** distance between the rear part of the lenses and the target object;
- **Reference image:** stored image that acts as the reference image during processing;
- **ROI:** abbreviation of "Region of Interest", and also "rectangle of interest", this is the area of the acquired image that is controlled/measured;
- **Sample image:** see Reference image;
- **Status:** the result of the inspection referred to the individual control/measurement (which can indicate "OK" or "Failure" values);
- **Target image:** the image acquired by the sensor, which is then processed/inspected;
- **Task:** literally "job" or "operation". Indicates each single action that, as part of a group of activities, leads to the solution of a problem.