

Status: 09/2019



Products need labeling
Label printers
for industrial applications



SQUIX
Made in Germany

Contents

- 3** SQUIX label printers for industrial applications
- 4 - 5** Industrial printers with a left-aligned material guide
- 6 - 7** Label printers with a centered material guide
- 8** Operation panel
- 9** Print heads, print rollers, interfaces
- 10 - 11** Technical data
- 12 - 13** Label software cablabel S3
 - Printing in stand-alone operation
 - Printer control and administration
- 14 - 17** Accessories
- 18 - 19** Applicator S1000
- 20** Applicator S3200
 - Demand modules
- 21** All-around labeler
 - Mounting equipment
- 22** Label printers with special covers or protection chassis
- 23** Maintenance, services, training
- 24 - 26** Delivery program

Scopes of delivery, design and technical specifications correspond to the date of the printing.
Subject to change. The data provided in the catalog do not represent any warranty or guarantee.



Information is also
available on the Internet:
www.cab.de/en/squix



SQUIX

Label printers for industrial applications

The professional **SQUIX** label printers are the further development of the successful A⁺ printer series. They fit with a wide range of industrial applications. They have been developed with focus on easy and convenient operation and high reliability.

The print mechanics and the chassis are made of high-quality materials and perfectly match in terms of shape and function. A large number of peripherals and software enable customer-specific solutions.

Whether they are operated in stand-alone mode, in a PC application or within a network - the rugged SQUIX printers are always up to the mark. The high-speed processor ensures fast job processing and immediately provides the required label.

- innovative technology
- easy operation
- accurate imprint
- reliable and fast printing
- compact, appealing design
- highest quality standards

Sample applications:

PCB labels

When only little space is available
– smallest label size 4 x 3 mm

Type plates

Pin sharp fonts, graphics and barcodes
up to 600 dpi

Cardboard box and pallet labels

up to A5 size



Industrial printers



Material guide
left-aligned



1.1 The slim one

for small labels when little footprint is available

Label printer		SQUIX 2	
Printable resolution	dpi	300	600
Print speed	up to mm/s	250	150
Print width	up to mm	56.9	54.1

1.2 The universal one

The best-selling industrial device with a wide range of accessories.

Label printer		SQUIX 4.3		SQUIX 4	
Printable resolution	dpi	203	300	300	600
Print speed	up to mm/s	250	250	300	150
Print width	up to mm	104	108.4	105.7	105.7

1.3 The wide one

for Odette and UCC labels in applications in logistics

Label printer		SQUIX 6.3	
Printable resolution	dpi	203	300
Print speed	up to mm/s	250	250
Print width	up to mm	168	162.6

Basic versions



for printing on labels and continuous materials that are wound on rolls or fanfold. The material is separated at the jagged tear-off edge. Optionally, it can be cut or externally rewound.

Peel-off versions P



In addition to the basic version the labels can also be dispensed. The label is separated from the carrier material after the printing. It can be removed manually or by an applicator. Delivery includes digital I/O interface

The extra wide one

for pallet and barrel labels

Label printer		A8 ⁺
Printable resolution	dpi	300
Print speed	up to mm/s	150
Print width	up to mm	216

For further information on the A8⁺ see
www.cab.de/en/a8plus



Details



Label printer
SQUIX 4 P

1 Hinged cover

The two-part cover made of impact-proof plastics folds when it is opened. Therefore, only little footprint is needed. The large panoramic window enables to check the material consumption and to track the full printing process.

2 Plungers

One plunger is fixed at the inner side. The second one is adjusted that far to the edge of the label until a good print image is ensured.

3 Rugged metal chassis

made of cast aluminum; basis to assemble all components

4 Print rollers' coating

Synthetic rubber is standard for accurate imprint; silicone is available as an option for an extra long service life at a higher imprint tolerance

5 Peel-off function

Via the peel-off plate, the label is separated from the carrier material. Accurate imprint and dispense are achieved with the powered rewind assist roller and the pinch roller.

6 Periphery connection

Additional modules are easy to connect. All peripheral devices are plugged to the printer with two pins and fixed with a screw.

7 Ribbon holder

Fast and easy exchange of the ribbon is enabled with the three-part tightening axles.

8 Roll holder

The spring-mounted margin stop with a screw cap enables constant tension during material feed and therefore improves accurate imprint. If rolls with 100 mm core diameter are processed, an adapter is recommended.

9 Internal rewinder

Peel-off versions allow to rewind labels or carrier materials with or without a cardboard core. The three-part tightening axle provides easy material handling.

10 Rocker

When printing is started, the spring-mounted rocker with pulleys made of Teflon dampens the tension and therefore improves accurate imprint.

11 Material guide

It is mounted on the rocker. The stop is adjusted to the edge of the label with the rotary knob.

Label printers M series



Material guide centered



Basic version



Peel-off version P

1.4 The accurate and versatile one

for printing on all materials that are wound on rolls or reels or fanfold - especially very small labels or slim continuous materials such as pressed shrink tubes.

As regards the label width, no adjustment of the plungers is needed.

Width-adapted print rollers are provided for slim materials.

Label printer		SQUIX 4.3 M		SQUIX 4 M	
Printable resolution	dpi	203	300	300	600
Print speed	up to mm/s	250	250	300	150
Print width	up to mm	104	108.4	105.7	105.7

Differences compared to a left-aligned material guide

1 Ribbon holder

Easy insertion of the ribbons is enabled with the three-part tightening axles. A preprinted ruler simplifies the adjustment.

2 Roll holder

When setting the margin stop, the material roll is automatically centered. If rolls with 100 mm core diameter are processed, an adapter is recommended.

3 Plungers

Both plungers are fixed for all material widths. No print head settings or adjustments are necessary.

4 Material guide

The material guide just in front of the print roller provides accurate imprint. The material width is adjusted with a spindle.

5 Print rollers' coating

Synthetic rubber is standard for accurate imprint; silicone is available as an option for an extra long service life at a higher imprint tolerance

6 Slim print rollers

In order to achieve accurate imprint with slim materials and ribbons, also slim print rollers are needed. These prevent from print roller wear, print head contamination and errors during material feed. Coating: synthetic rubber

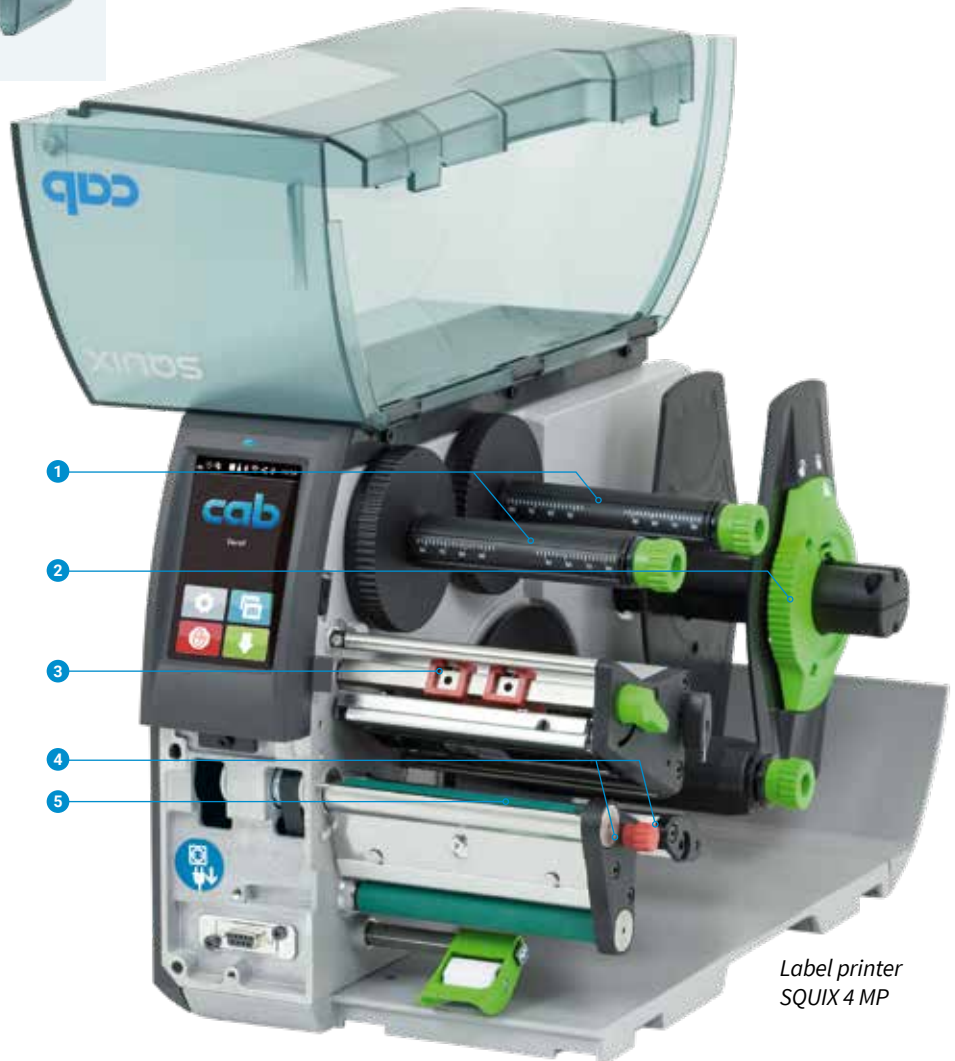

Label printer SQUIX 4 MP



Label printers MT series



**Material guide
centered
with separator**



1.5 The textile printer

It is also possible to print on labels or continuous materials that are wound on rolls or reels.

As regards the label width, no adjustment of the plungers is needed.

Width-adapted print rollers are provided for slim materials.

Label printer		SQUIX 4.3 MT	SQUIX 4 MT	
Printable resolution	dpi	300	300	600
Print speed	up to mm/s	250	300	150
Print width	up to mm	108.4	105.7	105.7

Differences compared to a left-aligned material guide

1 Ribbon holder

Easy insertion of the ribbons is enabled with the three-part tightening axles. A preprinted ruler simplifies the adjustment.

2 Roll holder

When setting the margin stop, the material roll is automatically centered. If rolls with 100 mm core diameter are processed, an adapter is recommended.

3 Plungers

Both plungers are fixed for all material widths. No print head settings or adjustments are necessary.

4 Antistatic brush

Particularly with plastic materials the electrostatic charge is discharged after printing.

5 Separator

At high heat energy the ribbon can stick with the textile tape. A roller reliably separates the material from the ribbon.

6 Material guide

The material guide just in front of the print roller provides accurate imprint. The material width is adjusted with a spindle.

7 Print rollers' coating

Synthetic rubber is standard for accurate imprint; silicone is available as an option for an extra long service life at a higher imprint tolerance

8 Slim print rollers

In order to achieve accurate imprint with slim materials and ribbons, also slim print rollers are needed. These prevent from print roller wear, print head contamination and errors during material feed. Coating: synthetic rubber

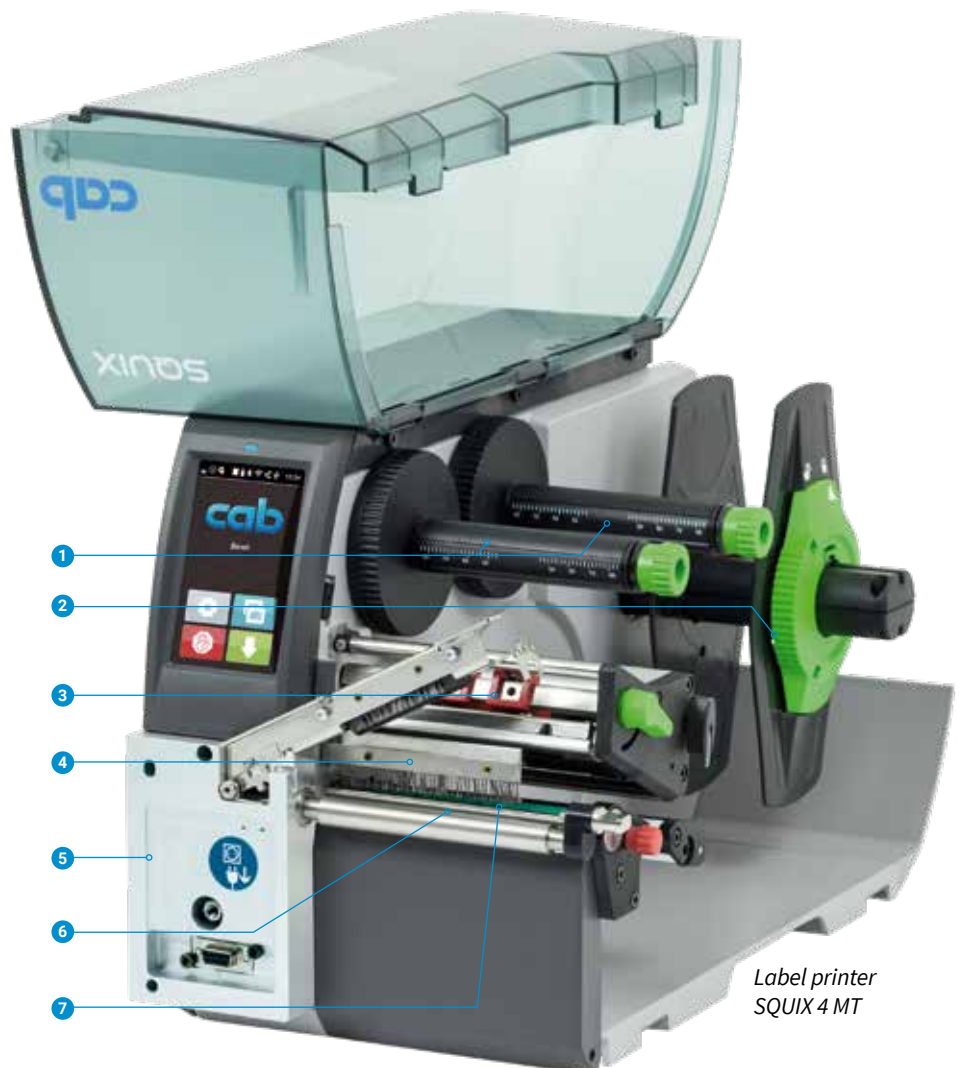

Label printer
SQUIX 4 MT







Operation panel

Intuitive and easy operation with self-explanatory symbols to configure the device setups

- 1 **LED signal:** Power ON
- 2 **Status bar:** Data reception, Record data stream, Ribbon pre-warning, SD memory card / USB memory stick plugged in, Bluetooth, WLAN, Ethernet, USB Slave, Time
- 3 **Printer status:** Ready, Pause, Number of printed labels per print job, Label in peel-off position, Awaiting external start signal
- 4 **USB slot** to connect the Service Key or a memory stick, to load data in the IFFS storage
- 5 **USB WLAN stick** 2.4 GHz 802.11b/g/n included as an extra item in the scope of delivery; In hotspot mode it is possible to directly connect a mobile device with the printer via WLAN.

6 Operation

	Cutter / perforation cutter:	cutting
	External rewinder:	winding outside or inside
	Tear-off or peel-off mode:	print label
	Applicator:	Printing and labeling in individual steps

 Jump to menu

 Interrupt and continue print job

 Stop and delete all print jobs

 Reprint last label

 Label feed



Setup options



Printing parameters



Print position Y



Print speeds



Video tutorials

External operation panel

providing the same functionality as on the printer

Landscape or portrait mode display

Users are free to choose whether to operate the printer on the external panel or on the one integrated in the device.

Printer connection: USB 2.0 Hi-speed device

- 1 **LED:** Power ON
- 2 **USB slot** to connect the Service Key or a memory stick, to load data in the IFFS storage
- 3 **Connecting cable USB**, lengths 1,8 m, 3 m, 5 m
Use only specified cables if length succeeds 3 m;
for dimensions see assembly instructions



Print heads



All print heads are freely interchangeable at equal width. They are automatically detected and calibrated by the CPU.

Major data such as running performance, maximum operating temperature and heat energy are directly stored in the print head. The data can be read at the plant.

Print heads for SQUIX 2, SQUIX 4 - 300, 600 dpi

for a sharp-edge print image
for type plates with small fonts, graphics
and material marking with high energy needs

Print heads for SQUIX 4.3, SQUIX 6.3 - 203, 300 dpi

durable, for rough surroundings and thermal direct printing

Print rollers in two types of material



Print rollers DR

Coating: synthetic rubber
They are suited for accurate imprint and provided as standard.

Print rollers DRS

Coating: silicone
They have an extra long service life at a higher imprint tolerance.

Interfaces on the back of the device



1 for a **SD memory card**

2 **2 x USB host** to connect a Service Key, USB memory stick, keyboard, barcode scanner, USB Bluetooth adapter, USB WLAN stick, external operation panel

3 **USB 2.0 Hi-speed device** to connect a PC

4 **Ethernet 10/100 BASE-T**

5 **RS232C** 1,200 to 230,400 baud/8 bit

6 3.1 **Digital I/O interface** standard with peel-off devices, accessory to basic devices
Labeling is started with a PLC, a sensor or a hand switch.
At the same time, status and error messages are issued.

Compliant with IEC/EN 61131-2, type 1+3; all inputs and outputs are galvanically isolated and protected from reverse polarity. In addition, outputs are short circuit protected.

Inputs PNP

Start print and apply
Print first label
Reprint
Delete print job
Label dispensed
Interrupt labeling
Pause
Reset

Outputs PNP; NPN on request

Printer/periphery ready
Print job available
Applicator in initial position
Paper feed ON
Label in peel-off position
Applicator in apply position
Ribbon pre-warning
Common error

Technical data

● typical ○ possible ■ standard □ option

Label printer		Type	1.1		1.2			1.3		1.4			1.5				
			SQUIX 2	SQUIX 4.3	SQUIX 4	SQUIX 6.3	SQUIX 4.3 M	SQUIX 4 M	SQUIX 4.3 MT	SQUIX 4 MT							
Material feed			left-aligned						centered								
Printing method	Thermal transfer		●	●	●	●	●	●	●	●	●	●	●	●	●		
	Thermal direct		○	-	●	●	○	-	●	●	●	●	○	-	●	○	-
Printable resolution	dpi		300	600	203	300	300	600	203	300	203	300	300	600	300	300	600
Print speed	up to mm/s		250	150	250	250	300	150	250	250	250	250	300	150	250	300	150
Print width	up to mm		56.9	54.1	104	108.4	105.7	105.7	168	162.6	104	108.4	105.7	105.7	108.4	105.7	105.7
Start of printing	Distance to locating edge	mm	2		2.8		1.2		0.5		3.2		25		centered		
Material¹⁾																	
Paper, cardboard, plastics PET, PE, PP, PI, PVC, PU, acrylate, Tyvec			●		●			●		●			●		●		
Shrink tubes	ready-for-use		-		○			○		●			○		○		
	continuous, pressed		-		-			-		●			○		○		
Textile tapes			-		-			-		○			○		●		
Packing	on rolls, fanfold		●		●			●		●			●		●		
	on reels		-		-			-		-			-		-		
	Roll diameter	up to mm	205														
	Core diameter	mm	38.1 - 76														
	Winding		outside or inside														
Labels	Width	mm	4 - 63		20 - 116			46 - 176		4 - 110			4 - 110				
	Height excl. label backfeed ²⁾	from mm	4		4			6		3			4				
	incl. label backfeed ²⁾	from mm	4		6			12		4			6				
	incl. lab. backf. / peel-off	from mm	6		6			12		6			-				
	Thickness	mm	0.03 - 0.6														
Liner material	Width	mm	24 - 67		24 - 120			50 - 180		9 - 114			9 - 114				
	Thickness	mm	0.03 - 0.16														
Continuous material	Width	mm	24 - 67		24 - 120			50 - 180		9 - 114			9 - 114				
	Thickness	mm	0.05 - 0.5														
	Weight (cardboard)	up to g/m ²	300														
Shrink tubes	Width ready-for-use	up to mm	-		120			-		114			114				
	continuous, pressed	mm	-		-			-		4 - 85			4 - 85				
	Thickness	up to mm	-		1.1			-		1.1			1.1				
Ribbon ³⁾	Ink side		outside or inside														
	Roll diameter	up to mm	80														
	Core diameter	mm	25.4														
	Variable length	up to m	450														
	Width	mm	25 - 67		25 - 114			50 - 170		25 - 114			25 - 114				
Internal rewinder on peel-off device																	
Outside diameter	up to mm	142															
Core diameter	mm	40															
Winding		outside															
Printer sizes and weights																	
Width x Height x Depth	mm	200 x 288 x 460		252 x 288 x 460			312 x 288 x 460		252 x 288 x 460			252 x 288 x 460					
Weight	kg	9		10			14		10			10					
Label sensor indicating the position																	
Gap sensor	for	labels or punch marks and end of material, print marks on transparent materials															
Reflective sensor	reflex from below or top	for	labels and end of material, print marks on non-transparent materials														
Distance of sensor	to locating edge	left-aligned mm	5 - 26		5 - 60			5 - 60		-			-				
	from centre to locating edge	centered mm	-		-			-		0 - 55			0 - 55				
Material passage	up to mm	2															
Electronics																	
Processor 32 bit clock rate	MHz	800															
Main memory (RAM)	MB	256															
Data memory (IFFS)	MB	50															
Slot to connect a SD memory card (SDHC, SDXC)	up to GB	512															
Battery for time and date, real-time clock		■															
Data memory when power is switched off (e.g. serial numbering)		■															
Interfaces																	
RS232C	1,200 to 230,400 baud/8 bit	■															
USB 2.0 Hi-speed device to connect a PC		■															
Ethernet 10/100 BASE-T		LPD, IPv4, RawIP printing, DHCP, HTTP/HTTPS, FTP/FTPS, SMTP, SNMP, TIME, NTP, Zeroconf, SOAP web service, VNC															
1 x USB host on the operation panel	for	Service Key or USB memory stick															
1 x USB host on the operation panel	for	USB WLAN stick 2.4 GHz 802.11b/g/n															
2 x USB host on the back of the device	for	Service Key, USB memory stick, keyboard, barcode scanner, USB Bluetooth adapter, USB WLAN stick, external operation panel															
USB WLAN stick 2.4 GHz 802.11b/g/n		■ (included as an extra item in the scope of delivery)															
USB WLAN stick 2.4 GHz 802.11b/g/n + 5 GHz 802.11a/n/ac, Hotspot or Infrastructure Mode		□															
USB Bluetooth adapter		□															
Peripheral connection USB host, 24 VDC		■															
Digital I/O interface with 8 inputs and outputs	Peel-off device	■															
	Basic device	□															

¹⁾ The material specifications are standard values. Applications with small labels, thin, slim, thick and stiff materials as well as strongly adherent labels have to be tested.

²⁾ in cases of tearing off, cutting, rewinding

³⁾ The ribbon should at least correspond with the width of the liner material.

Technical data

■ standard □ option

Operating data		
Power supply	100 - 240 VAC, 50/60 Hz, PFC	
Power consumption	Standby < 10 W / typical 100 W	
Temperature / humidity	Operation	+5 - 40°C / 10 - 85 %, not condensing
	Stock	0 - 60°C / 20 - 85 %, not condensing
	Transport	-25 - 60°C / 20 - 85 %, not condensing
Approvals	CE, FCC Class A, ICES-3, cULus, CB, CoC Mexico, CCC, EAC, BIS, BSMI, KC-Mark, RCM	
Operation panel		
Colored LCD touch display	Screen diagonal	" 4,3
	Resolution Width x Height px	272 x 480
Setup options		
	Print Labels Ribbon Tear-off Peel-off Cut Apply Interfaces Error	Region: - Language - Country - Keyboard - Time zone Time Display: - Brightness - Power saving mode - Orientation Interpreter
Status bar		
	Data reception Record data stream Ribbon pre-warning SD memory card plugged USB memory stick plugged	Bluetooth WLAN Ethernet USB slave Time
Monitoring		
	Ribbon pre-warning End of ribbon Direction of ribbon winding End of material	Periphery error Print head voltage Print head temperature Print head open Pinch roller open (peel-off device, separator)
Test routines		
System diagnostics	on start-up, including print head detection	
Information display, test printout, analysis	Status printout	Test grid
	Fonts list	Label profile
	List of devices	List of events
	WLAN status	Monitor mode
Status reports	- Printout of device settings, e.g. print lengths and service hours - Device status request by software command - Display of, e.g., network errors, no links, barcode errors, periphery errors, etc.	
Fonts		
Font types internally provided	5 bitmap fonts: 12 x 12 dots 16 x 16 dots 16 x 32 dots OCR-A OCR-B	7 vector fonts: AR Heiti Medium GB-Mono CG Triumvirate Condensed Bold Garuda HanWangHeiLight Monospace 821 Swiss 721 Swiss 721 Bold
to be stored	TrueType fonts	
Character sets	Windows-1250 to -1257 DOS 437, 737, 775, 850, 852, 857, 862, 864, 866, 869 EBDIC 500 ISO 8859-1 to -10 and -13 to -16 WinOEM 720 UTF-8 MacRoman DEC MCS KOI8-R	
	Western European Eastern European Chinese simplified Chinese traditional Thai	Cyrillic Greek Latin Hebrew Arabic
Bitmap fonts	Widths and heights 1 - 3 mm Zoom factors 2 to 10 Orientations 0°, 90°, 180°, 270°	
Vector / TrueType fonts	Size in width and height 0,9 - 128 mm Variable zoom Orientation 360° in steps of 1°	
Font styles	bold, italic, underlined, outline, inverse - depending from the font types	
Character spacing	variable or monospace	

Graphics		
Graphic elements	Lines, arrows, rectangles, circles, ellipses - filled or filled with fading	
Graphic formats	PCX, IMG, BMP, TIF, MAC, GIF, PNG	
Barcodes		
Linear	Code 39, Code 93 Code 39 Full ASCII Code 128 A, B, C EAN 8, 13 EAN/UCC 128/GS1-128 EAN/UPC Appendix 2 EAN/UPC Appendix 5 FIM HIBC	Interleaved 2/5 Ident and routing code of Deutsche Post Codabar JAN 8, 13 MSI Plessey Postnet RSS 14 UPC A, E, E0
	2D and stacked	DataMatrix DataMatrix Rectangle Extension QR code Micro QR code GS1 QR code GS1 DataMatrix PDF 417 Micro PDF 417 UPS MaxiCode GS1 DataBar Aztec Codablock F RSS 14 truncated, limited, stacked, stacked omni-directional
All codes are variable in terms of height, modular width and ratio; orientations 0°, 90°, 180°, 270° check digit, plain text printout and start / stop code are options depending from the type of code		
Software		
Label software	cablabel S3 Lite cablabel S3 Viewer cablabel S3 Pro cablabel S3 Print	■ ■ □ □
Also running with	CODESOFT NiceLabel BarTender	
Stand-alone operation		■
Windows printer drivers WHQL certified	Windows Vista Windows 7 Windows 8 Windows 8.1 Windows 10	Server 2008 Server 2008 R2 Server 2012 Server 2012 R2 Server 2016 Server 2019
Apple Mac OS X printer drivers	from version 10.6	■
Linux printer drivers	from CUPS 1.2	■
Programming	JScript printer language abc Basic Compiler	■ ■
Integration	SAP Database Connector	■ ■
Administration	Printer control Configuration in Intranet and Internet Network Manager (in preparation)	■ ■ ■

cab uses free and Open Source Software in its products.
For information see www.cab.de/opensource

Label software cablabel S3

Designing, printing, administrating with cablabel S3

cablabel S3 opens up the full potential of cab devices.

First of all, the label must be designed. Only when it comes to printing it has to be decided whether the label shall be processed on a label printer, a print and apply or marking laser system.

cablabel S3 is of a modular design which makes it adaptable to requirements step by step. To support functions like native JScript programming, elements such as the JScript Viewer are embedded as plug-ins. The designer user interface and the JScript code are synchronized in real time. Special functions like the Database Connector or barcode testers can be integrated.

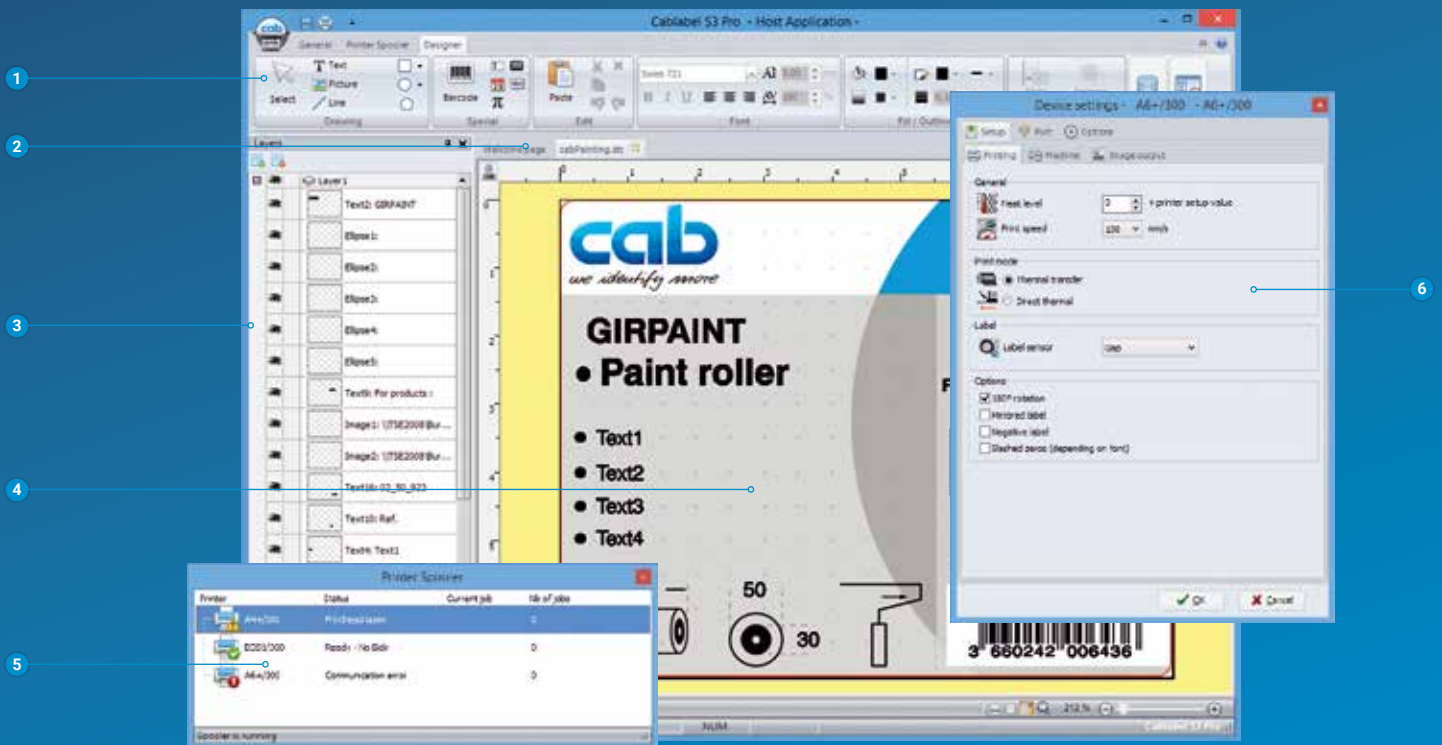

- 1 **Toolbar**
to create different label objects
- 2 **Tabs**
to quickly switch from one running label design to another
- 3 **Layers**
to administrate different label objects
- 4 **Designer**
simplifies the label design and displays the label WYSIWYG
- 5 **Printer spooler**
to monitor all print jobs and the state of the printer
- 6 **Drivers**
for setting and the communication with devices

Printing in stand-alone operation

This operating mode is the printer's ability to select and print labels even when it is not connected to a host system.

The label has to be designed with a software such as cablabel S3 or by direct programming with a text editor on a PC. Label formats, texts, graphics as well as database contents are stored on a memory card, a USB memory stick or in the internal IFFS memory.

Only variable data are sent to the printer via a keyboard, a barcode scanner, scales or other host systems and/or recalled by the Database Connector from the host and printed.



For further information see
www.cab.de/en/cablabel



Printer control and administration

Printer drivers

To control the printer with a software other than cablabel S3, cab provides drivers in 32 / 64 bit for operating systems starting from Windows Vista, Mac OS 10.6 and Linux with CUPS 1.2.

Windows¹⁾ drivers
 cab printer drivers are certified according to WHQL. They ensure optimum stability on the Windows operating system.

Mac OS X²⁾ drivers
 cab provides CUPS-based printer drivers for Mac OS X applications.

Linux drivers³⁾
 Linux drivers are CUPS-based.

Drivers are offered on the DVD delivered with the printer and for free download at www.cab.de/en/support

Printer programming

JScript
 To control the printer, cab has developed the embedded programming language JScript. See manual for free download at www.cab.de/en/programming

abc Basic Compiler
 In addition to JScript and as an integral part of the firmware, it allows advanced printer programming before data are sent to printout. For example, external printer languages can be replaced without interfering in the current print job. Also data from other systems such as a scale, a barcode scanner or PLC can be integrated.

Printer integration

Printer Vendor Program
 As a partner in SAP's⁴⁾ Printer Vendor Program, cab has developed a replace method to enable easy control of a cab printer via SAPScript from SAP R/3. Only variable data are sent to the printer by the host. Pictures and fonts that had priorly been stored in the local memory (IFFS, memory card, etc.) are merged.

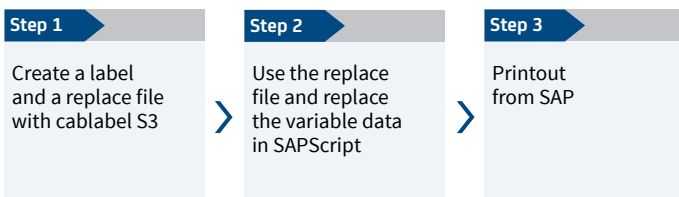

¹⁾ Windows is a registered trademark of Microsoft Corporation
²⁾ MAC OS X is a registered trademark of Apple Computer, Inc.
³⁾ Only for device series SQUIX (except of SQUIX MT), MACH 4S, EOS, Hermes+ and PX
⁴⁾ SAP and all corresponding logos are trademarks or registered trademarks of SAP SE

Printer administration

Configuration in Intranet and Internet
 The HTTP and FTP server integrated in the printer via standard programs like a web browser or FTP clients allows printer control and configuration, firmware updates and memory card administration. Via email or SNMP, the SNMP and SMTP client datagram sends status, warning and error messages to administrators and users. Time and date are synchronized by a time server.



Network Manager in preparation
 It is possible to simultaneously manage several printers within the network. Control, configuration, firmware updates, memory card administration, data synchronization and PIN administration are supported from one single location.

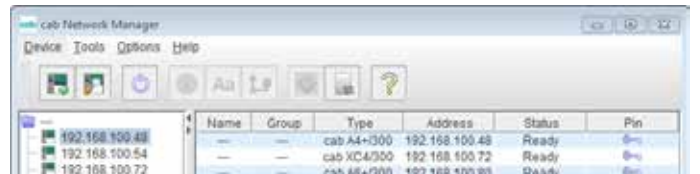

Database Connector
 Printers connected to a network may directly access data from a central ODBC or OLEDB-ready database and print it on a label. While printing, data can be rewritten to the database.











Overview of accessories



● Typical ○ Possible ■ Standard □ Option

Pos.	Printer add-ons	Basic device	Peel-off device	1.1	1.2	1.3	1.4	1.5
				SQUIX 2	SQUIX 4.3 SQUIX 4	SQUIX 6.3	SQUIX 4.3 M SQUIX 4 M	SQUIX 4.3 MT SQUIX 4 MT
2.1	External operation panel	●	●	□	□	□	□	□
	Connecting cable USB, lengths 1,8 m, 3 m, 5 m	●	●	□	□	□	□	□
2.2	Print rollers DR4-M25, -M50, -M80	●	●	-	-	-	□	□
	Print roller DRS	●	●	□	□	□	□	□
2.3	Antistatic brush	●	●	□	□	□	□	■
2.6	Adapter 100	●	●	□	□	□	□	□
2.7	SD memory card 8 GB	●	●	□	□	□	□	□
2.8	USB memory stick 8 GB	●	●	□	□	□	□	□
2.9	USB WLAN stick	●	●	□	□	□	□	□
2.10	USB Bluetooth adapter	●	●	□	□	□	□	□
2.11	Barcode tester CC100	●	●	□	□	□	□	-
Label peel-off								
2.12	Present sensor PS800	-	●	□	□	□	-	-
2.13	Present sensor PS900	-	●	□	□	□	□	-
2.14	Present sensor PS1000 MP	-	●	-	-	-	□	-
2.15	Extended peel-off plate DP410	-	●	□	□	□	□	-
2.16	Product sensor with reflector	-	●	□	□	□	□	-
Interfaces, switches								
3.1	Digital I/O interface	●	●	□	□	□	□	□
3.2	I/O interface connector, SUB-D 25 pin	●	●	□	□	□	□	□
3.3	Label selection - I/O box	●	●	□	□	□	□	□
3.4	Hand switch TR2	●	●	□	□	□	□	□
3.5	Foot switch	●	●	□	□	□	□	□
Connecting cable								
4.1	Connecting cable RS232 C, length 3 m	●	●	□	□	□	□	□
Label cutting, perforating, stacking								
5.1	Cutters CU200, CU400, CU600 with cutter tray	●	○	□	□	□	□	□
		●	○	-	□	-	□	-
5.2	Perforation cutters PCU400/2,5, PCU400/10	●	○	-	□	-	□	□
5.3	Stacker with cutter and base frame ST400 M	●	○	-	-	-	□	□
Label rewinding, unwinding								
6.1	Rewind guide plates RG200, RG400	-	●	□	□	-	□	-
6.3	External rewinders ER1/210, ER2/210 ¹⁾	●	○	-	□	□	○	-
6.5	External rewinders ER4/300, ER6/300	●	○	-	□	□	○	-
6.6	External unwinders EU4/300, EU6/300	●	○	-	□	□	□	□
6.7	Adapter kit for rewinders and unwinders	●	○	-	□	□	□	□
Applicators, demand modules								
7.1-7.5	Applicators S1000-220, -300, -400	-	●	□	□	□	□	-
7.6-7.8	Applicator S3200	-	●	□	□	-	□	-
7.9	Demand modules S5104, S5106	-	●	-	□	□	-	-
7.10	All-around labeler	-	●	□	□	-	□	-
Mounting equipment								
8.1	Mounting plate	-	●	□	□	-	-	-
8.2	Profiles 40, 80, 120 mm	-	●	□	□	-	-	-
8.3	Base plate 500 x 255 mm	-	●	□	□	-	-	-
8.4	Floor stand 1600	-	●	□	□	□	-	-
8.5	Printer holder	-	●	□	□	□	-	-
Special cover								
9.2	Hinged cover for the food industry	●	●	□	□	□	□	□
Protection chassis								
9.3	Stainless steel chassis for food applications	●	●	-	□	□	□	-
9.4	Dust protection chassis	●	●	-	□	□	□	-
	Protection chassis for cleanroom applications	●	●	-	□	□	□	-

¹⁾ from the A+ printer series, adapted to SQUIX; provided until the external rewinders ER20x are available

Accessories

2.1		External operation panel
		Connecting cable USB , length 1,8 m
		Connecting cable USB , length 3 m
		Connecting cable USB , length 5 m
2.2		Print roller DR4-M25 Material width up to 25 mm Synthetic rubber coating for accurate imprint
		Print roller DR4-M50 Material width up to 50 mm Synthetic rubber coating for accurate imprint
		Print roller DR4-M80 Material width up to 80 mm Synthetic rubber coating for accurate imprint
		Print roller DRS4 Material width up to 120 mm Silicone coating for an extra long service life at a higher imprint tolerance
2.3		Antistatic brush Particularly with plastic materials the electrostatic charge is discharged after printing.
2.6		Adapter 100 for label rolls with 100 mm core diameter and more than 180 mm outside diameter
2.7		SD memory card 8 GB
2.8		USB memory stick 8 GB
2.9		USB WLAN stick 2.4 GHz 802.11b/g/n + 5 GHz 802.11a/n/ac in infrastructure mode with rod antenna for extended reach
2.10		USB Bluetooth adapter
2.11		Barcode tester CC100 for linear and 2D barcodes The readability or content of a horizontally or vertically printed barcode is checked by a camera right after the printing. In case of a faulty code printing is stopped and the label removed. The tester can be used in tear-off mode, peel-off mode or with an external rewinder. For further information see the operator's manual.

Label peel-off		
2.12		Present sensor PS800 for a left-aligned material guide The sensor detects the label in peel-off position. After the label has been removed the next one is automatically printed. Label width from 16 mm Label height from 6 mm Distance to locating edge 7 mm
2.13		Present sensor PS900 for a left-aligned or centered material guide The moveable sensor is foremost used with very small labels or labels that are shaped according to user specifications. After the label has been removed the next one is automatically printed. Label width from 4 mm Label height from 6 mm Left-aligned: distance to locating edge 12-60 mm centered: position middle centered
2.14		Present sensor PS1000 MP for a centered material guide The sensor detects the label in peel-off position. After the label has been removed the next one is automatically printed. Label width from 4 mm Label height from 6 mm Position middle centered
2.15		Extended peel-off plate DP410 for strong-adhesive labels or labels with a thick carrier material that are hard to remove. Only in conjunction with printing on demand triggered via a display button or control signal. A present sensor cannot be used.
2.16		Product sensor with reflector Reflective light barrier to automatically detect a product on the conveyor belt
Interfaces, switches		
3.1		Digital I/O interface Labeling is started with a PLC, a sensor or a hand switch. At the same time, status and error messages are issued. Standard with peel-off devices, accessory to basic devices
3.2		I/O interface connector , SUB-D 25 pin with screw clamps to connect all control signals to the I/O interface
3.3		Label selection - I/O box Up to 16 different labels per box can be selected from the memory card by a master control, e.g. PLC. Two boxes can be connected. The I/O box allows simple PLC control processes with four inputs and outputs each via abc programming.
3.4		Hand switch TR2 to connect to the I/O interface
3.5		Foot switch to connect to the I/O interface
Connecting cable		
4.1		Connecting cable RS232 C 9/9 pin, length 3 m

Accessories

5.1



Label cutting, perforating, stacking

Cutter CU

Paper labels, self-adhesive labels, cardboard, textile or plastic materials as well as shrink tubes can be cut.

Cutter tray

to collect up to approx. 50 labels

Technical data			Cutter			
			CU200	CU400		CU600
To be used with			SQUIX 2	SQUIX 4.3 SQUIX 4	SQUIX 4.3 M SQUIX 4 M SQUIX 4.3 MT SQUIX 4 MT	SQUIX 6.3
Material	Width	up to mm	67	120	114	180
	Weight cardboard	gr/m ²	60-300			
	Thickness	mm	0.05-1.1			
Cutting length		from mm	5			
Gap height		up to mm	2.5			
Cuts/min, without material		up to	100			
Stop print job when			final cutter position has not been reached			
Cutter tray						
Label height		up to mm	-	100	-	-

5.2



Perforation cutter PCU400

Continuous materials such as textiles or shrink tubes are perforated before they are manually separated. In addition, the materials can also be cut.

Technical data			Perforation cutter	
			PCU400/2,5	PCU400/10
To be used with			SQUIX 4.3, SQUIX 4, SQUIX 4.3 M, SQUIX 4 M, SQUIX 4.3 MT, SQUIX 4 MT	
Perforating	Web distance	mm	2.5	10
	Web width	mm	0.5	
Material	Width	up to mm	85	
	Weight cardboard	gr/m ²	60-300	
	Thickness	mm	0.05-1.1	
Cutting length		from mm	5	
Gap height		up to mm	2.5	
Cuts/min, without material		up to	100	
Stop print job when			final cutter position has not been reached	

5.3



Stacker with cutter ST400 M

- 1 The printed materials are cut and stacked. If the maximum stack height is reached, printing is interrupted. Limitations may apply to stiff or curved materials. We recommend to have these materials tested at our premise.
- 2 With the base frame the devices can be placed anywhere on the table.

Technical data			Stacker with cutter	
			ST400 M	
To be used with			SQUIX 4.3 M, SQUIX 4 M SQUIX 4.3 MT, SQUIX 4 MT	
Material	Width	mm	20-100	
	Weight cardboard	gr/m ²	60-300	
	Thickness	mm	0.05-0.8	
Cutting length		mm	20-150	
Gap height		up to mm	1.2	
Cuts/min, without material		up to	100	
Stop print job when			Final cutter position has not been reached, paper jam, stacker cover open, stack height has been reached	
Stack height		up to mm	100	



Support table - label W x H

The support table and the protective cover are adapted to the label size. They have to be ordered separately.

Accessories

6.1



Label rewinding

with or without a cardboard core

Rewind guide plates RG for internal rewinding

Internal rewinding is possible with peel-off printers. The peel-off plate is replaced by a rewind guide plate.

Technical data		Rewind guide plate		
		RG200	RG400	
	To be used with	SQUIX 2 P	SQUIX 4.3 P SQUIX 4 P	SQUIX 4.3 MP SQUIX 4 MP
	Material width	up to mm	67	120
	Roll diameter	up to mm	142	
	Tightening axle for core diameter	mm	38.1-40	
	Winding		outside	

6.3



External rewinders ER1, ER2 to connect directly to the printer

The rewriter is screwed with the label printer. Label winding is either outside or inside. The electronic swing arm control ensures that the winding stays consistent and tight.

Technical data		External rewriter	
		ER1/210	ER2/210
To be used with		SQUIX 4.3, SQUIX 4 SQUIX 4.3 M, SQUIX 4 M	SQUIX 6.3
Material width	up to mm	120	180
Roll diameter	up to mm	205	
Tightening axle for core diameter	mm	76	
Winding		outside or inside	

6.5



External rewinders ER4, ER6 with built-in power supply

The rewriter may be attached to any external printer. Label winding is either outside or inside. The electronic swing arm control ensures that the winding stays consistent and tight.

Technical data		External rewriter	
		ER4/300	ER6/300
To be used with		SQUIX 4.3, SQUIX 4 SQUIX 4.3 M, SQUIX 4 M	SQUIX 6.3
Material width	up to mm	120	180
Roll diameter	up to mm	300	
Tightening axle for core diameter	mm	76	
Winding		outside or inside	

6.7 Adapter kit for

- ER4, ER6 with SQUIX
- ER4, ER6 and EU4, EU6 with SQUIX

6.6



Label unwinding

External unwinders EU

ensure consistent label feed with heavy rolls. Either outside or inside wound rolls can be processed.

Technical data		External unwinder		
		EU4/300		EU6/300
To be used with		SQUIX 4.3 SQUIX 4	SQUIX 4.3 M SQUIX 4 M SQUIX 4.3 MT SQUIX 4 MT	SQUIX 6.3
Material width	up to mm	120	114	180
Roll diameter	up to mm	300		
Core diameter	mm	38.1		
	with adapter mm	76		
Winding		outside or inside		

6.7 Adapter kit for

- EU4, EU6 with SQUIX
- ER4, ER6 and EU4, EU6 with SQUIX

Applicator S1000



Labeling in real time

The applicator S1000 fixed to a SQUIX provides a cost-effective solution for peel-off printers - in semi-automatic operation or when vertically assembled in production lines. A stroke cylinder applies the label on the product.

- 1 Long service life**
Low wear because of a ball-bearing linear guidance
- 2 Variable product heights**
The stroke cylinder enables labeling at different heights. It is available in various stroke lengths.
- 3 Compressed air pressure regulation unit**
Micro filters prevent from contamination. The regulation unit enables a permanent high labeling quality.
- 4 High process reliability**
Supporting air, suction air and the stroke speed are all adjustable. If sensitive products and packagings are processed, the suction force can be reduced to less than 10N (1 kg). The vacuum holes are purged after every labeling process to avoid contamination.
- 5 Label sizes**
Label widths 25 to 176 mm and heights 25 to 200 mm can be applied.
- 6 Supporting air to blow the labels onto the pad**
- 7 Pad**
The labels are given to the pad and held there by vacuum. Pad and label are moved by a stroke cylinder to the product.

Pre-dispense button

to check the labeling process. Pushing the button once means that the label is printed and taken over by the applicator. Pushing the button again starts the labeling process.

Technical data	Applicator			
	S1000-220	S1000-300	S1000-400	
To be used with	SQUIX 2, SQUIX 4.3, SQUIX 4 SQUIX 4.3 M, SQUIX 4 M, SQUIX 6.3			
Cylinder stroke	mm	220	300	400
Tamp stroke below device	mm	64	144	244
Compressed air	bar	4.5		
Cycle time approx. ¹⁾		25 labels/min		

¹⁾ Calculated with 100 mm stroke below device, label height 100 mm, print speed 100 mm/s

Accessories

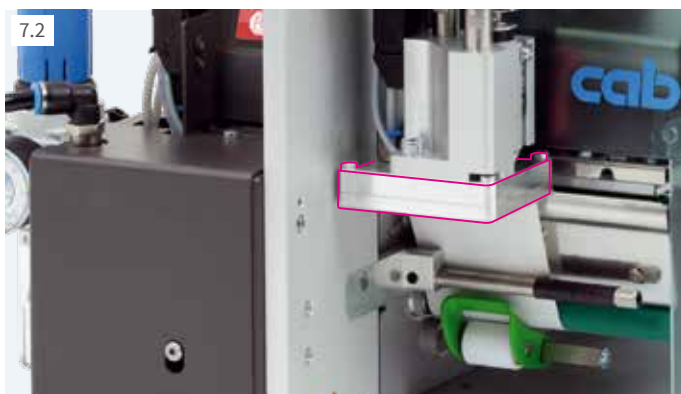

Universal pads

The rasterized vacuum holes are covered by a foil and pierced according to the label size.

Technical data	Universal pad			
	A1021	SQUIX 4.3 SQUIX 4	A1021 SQUIX 4	
To be used with	SQUIX 2	SQUIX 4.3 SQUIX 4	SQUIX 4.3 SQUIX 4	
Label width	mm	25-63	25-70	25-90
Label height	mm	25-60		25-90
Product surface		flat		
Product height		variable		
Product during labeling		not in motion		

Applicator S1000 accessories

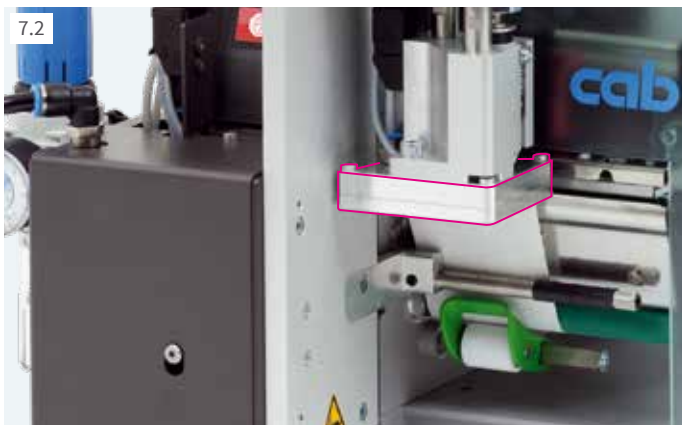

Tamp pads

are manufactured according to the label size.

Technical data		Tamp pad		
		A1021		
To be used with		SQUIX 2	SQUIX 4.3 SQUIX 4	SQUIX 6.3
Label width	mm	25-63	25-116	50-176
Label height	mm	25-200		
Product surface		flat		
Product height		variable		
Product during labeling		not in motion		

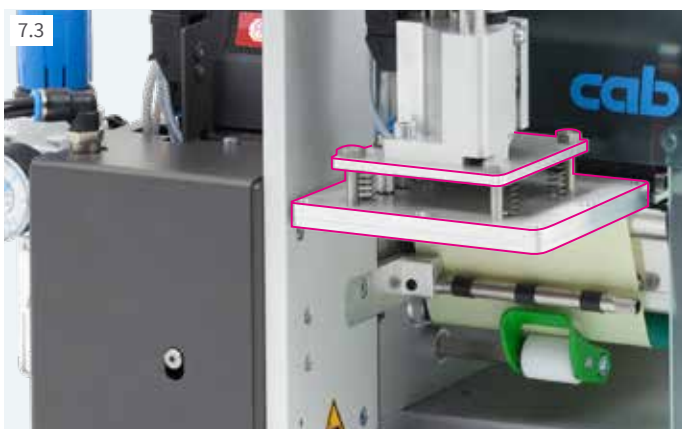

Universal pads spring-mounted

The spring deflection allows labeling even on curved surfaces. The rasterized vacuum holes are covered by a foil and pierced according to the label size.

Tamp pads spring-mounted

The spring deflection allows labeling even on curved surfaces; manufactured according to the label size

Technical data		Universal pad		Tamp pad	
		A1321	A1321	A1321	
To be used with		SQUIX 4.3, 4	SQUIX 4.3, 4	SQUIX 4.3, 4	SQUIX 6.3
Label width	mm	25-116	25-116	25-116	50-176
Label height	mm	25-102	25-152	25-200	
Product surface		flat			
Product height		variable			
Product during labeling		not in motion			

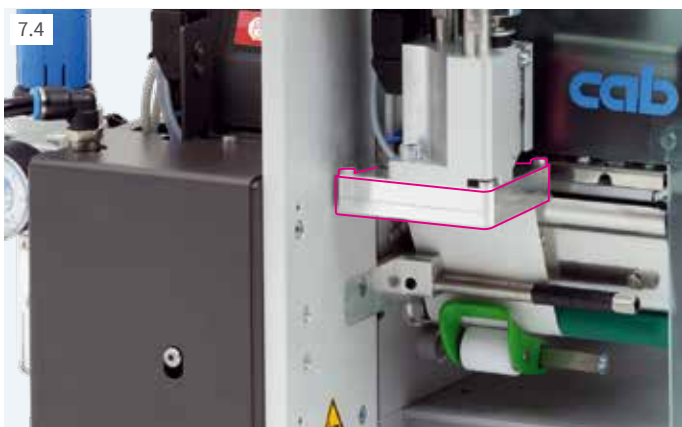

Blow pads

Labels may be blown on pressure-sensitive products. For this, the blow pad moves to a fixed height. The position of the product that has to be labeled is approx. 10 mm below.

Technical data		Blow pad		
		A2021		
To be used with		SQUIX 2	SQUIX 4.3, 4	SQUIX 6.3
Label width	mm	25-63	25-116	on request
Label height	mm	25-100		
Product surface		flat		
Product height		fixed		
Product during labeling		in motion or not in motion		

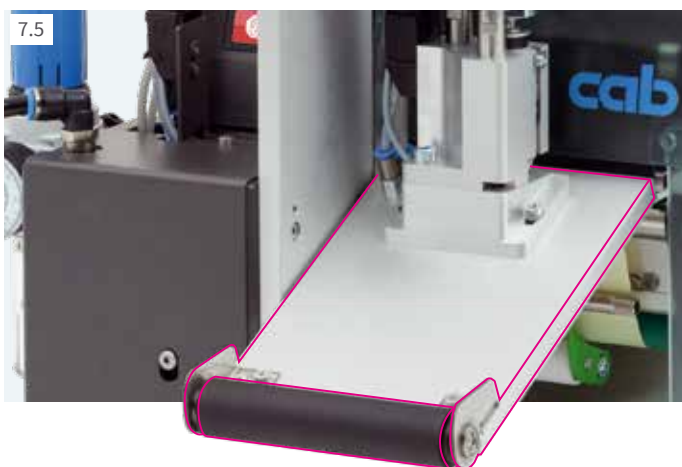

Roll-on pads

The label is moved right below the roll during the printing. The pad moves onto the product. The label is taken over by the product and rolled on.

Technical data		Roll-on pad	
		A1411	
To be used with		SQUIX 4.3, 4	SQUIX 6.3
Label width	mm	25-116	50-176
Label height	mm	80-200	
Product surface		flat	
Product height		variable	
Product during labeling		in motion	

Applicator S3200



Labeling in real time

An applicator S3200 fixed to a SQUIX provides a cost-effective solution for peel-off printers - in semi-automatic operation or when vertically assembled in production lines. With the S3200 printed labels are automatically applied on the product. The labels are placed with a rotary cylinder 45° to 95° to the horizontal and applied on the product with a short stroke cylinder. All information on the service life, predisense, compressed air regulation, process reliability and supporting air correspond with the applicator S1000 (see page 18).

	Applicator
Technical data	S3200
To be used with	SQUIX 2, SQUIX 4.3, SQUIX 4, SQUIX 4.3 M, SQUIX 4 M
Rotary cylinder	45°-95°
Stroke cylinder up to mm	30
Immersion depth up to mm pad F	5
Compressed air bar	4.5
Cycle time approx. ¹⁾	20 labels/min

¹⁾ Calculated with label height 40 mm, print speed 100 mm/s

Tamp or blow pads

are manufactured according to the label size.

	Tamp pad		Blow pad	
Technical data	A3200-1100		A3200-2100	
To be used with	SQUIX 2	SQUIX 4.3, 4	SQUIX 2	SQUIX 4.3, 4
Label width mm	4-63	10-116	10-63	10-116
Label height mm	6-80		10-80	
Product surface	flat			
Product during labeling	not in motion		in motion or not in motion	

Demand modules



Demand modules S5104, S5106

to label products in motion on a conveyor belt. A product sensor detects the labeling position. The peel-off process is started and at the same time the next label is printed. The transport speed has to be synchronized with the print speed. A reflective sensor monitors the positioning.

	Demand module	
Technical data	S5104	S5106
To be used with	SQUIX 4.3, SQUIX 4	SQUIX 6.3
Label width mm	25-116	50-176
Label height mm	25-210	
Distance from print line to peel-off plate mm	336-518	
Product surface	flat	
Product height	fixed	
Product during labeling	in motion, speed synchronized with the printer	
Cycle time approx. ¹⁾	60 labels/min	

¹⁾ Calculated with label height 100 mm, print speed 100 mm/s

All-around labeler



All-around labeler

With the module cylindrical objects can be labeled throughout the entire 360° circumference. The product is laid onto the rolls and the labeling process is started with a hand or foot switch.

Technical data	Tamp pad	
	A1021	M1021
To be used with	SQUIX 2	SQUIX 4.3, SQUIX 4
Label width	mm 25-63	25-116
Label height	mm	25-140
Product diameter	mm	12-40
Product surface	cylindric	
Product during labeling	in rotary motion	

Mounting equipment for the SQUIX label printers

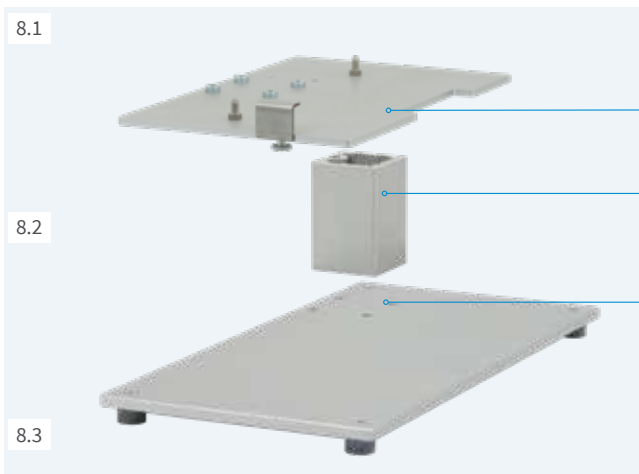

Mounting foot

to fix the print and apply system and the product holder

- 1 **Mounting plate**
The print and apply system is assembled on the mounting plate.
- 2 **Profile**
Aluminum square profile, standard lengths 40, 80, 120 mm; other lengths are possible on request
- 3 **Base plate**
to fix the product holder
Standard size 500 x 255 mm



Floor stand

It enables fast and flexible printer use in any production line. The labeling position is easily adjustable according to the height and width of the product. Four guide rollers provide mobility of the carriage. The floor stand is aligned with adjustable feet at the place of application.

Technical data	Floor stand	
	1600	
Total height	mm	1,600
Labeling height	up to mm	1,400
Offset to label centre	mm	230-500
Carriage Width x Height x Depth	mm	600 x 140 x 860



Printer holder

The label printer is fixed on the mounting plate and quick-locked.

Label printers with special covers or protection chassis

1.8



Printers with a conductive ESD surface

Available for all printer types

To protect from electrostatic charge, all parts of the casing are manufactured according to DIN EN 61340-5-1:2016.

Surface resistance according to DIN IEC 60093 $\leq 10^4$ ohm; charge is reduced from 1,000 V to 100 V in less than two seconds

Hinged upper cover available as an accessory

1.9



Printers with a detectable hinged cover for food applications

Available for all printer types

Magnetic cover so that splintered parts can be detected by metal detectors or x-ray inspection systems

Blue surface to distinguish from food products

If requested, the entire casing can be manufactured detectable.

The material complies with the food regulations such as EU no. 10/2011 and FDA CFR 21 177.2600.

9.3



Stainless steel chassis for food applications

Available for printer types SQUIX 4 and SQUIX 6

Labels are removed through the front opening.

To replace the materials, the front flap is opened and the printer is pulled out on telescopic rails. The flap is closed for steam jet cleaning.

Protection class IP69K according to EN 60529

9.4



Dust protection chassis

Available for printer types SQUIX 4 and SQUIX 6

Labels are removed through the front opening.

The fan and the filter provide overpressure and prevent from dust entering the chassis.

Protection class IP52 according to EN 60529

Protection chassis with extraction socket for cleanroom applications

Available for printer types SQUIX 4 and SQUIX 6

Maintenance



Label sensor

It can be unlocked with finger pressure and pulled out for cleaning.



Print head

Easy exchange in few simple steps. Adjustments or setups are basically not necessary.



Print roller

It can be easily unlocked with a screw for cleaning or replacement.

Assembly tool

ONE tool is provided with the printer to replace all components or to mount periphery.

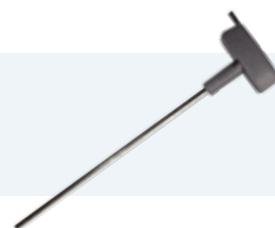

Services

Well-trained cab service engineers worldwide support in the maintenance and repair of the devices.

Send your printer to a cab service center or a cab service partner selected by us. Your device will be checked and repaired within few workdays. If requested, a loan device will be offered.

You prefer maintenance and repair on-site in your company? Then make an appointment with our Services Department: Phone **+49 721 6626 300**, Email: service.de@cab.de

Training

Enhance your know-how on cab devices with regard to an effective use, service and repair.

In Karlsruhe we offer trainings on the handling of the devices, label design, software, printer drivers, programming, database access as well as on how to integrate in networks or superior ERP systems. We gladly send you detailed information on all our current training offers on request.

Individually we offer trainings according to your specific demands - in Karlsruhe or on-site in your company.



Delivery program label printers







Pos.	Part no.	Printers with a left-aligned material guide	Part no.	Print heads	dpi	Part no.	Wear parts
1.1		5977030 Label printer SQUIX 2/300	5977384.001	Print head 2	300	5954102.001 5954978.001	Print roller DR2 Print roller DRS2
		5977031 Label printer SQUIX 2/600	5977385.001	Print head 2	600		
		5977032 Label printer SQUIX 2/300P	5977384.001	Print head 2	300	5954102.001 5954978.001 5954104.001	Print roller DR2 Print roller DRS2 Rewind assist roller RR2
		5977033 Label printer SQUIX 2/600P	5977385.001	Print head 2	600		
1.2		5977014 Label printer SQUIX 4.3/200	5977382.001	Print head 4.3	200	5954180.001 5954985.001	Print roller DR4 Print roller DRS4
		5977015 Label printer SQUIX 4.3/300	5977383.001	Print head 4.3	300		
		5977001 Label printer SQUIX 4/300	5977444.001	Print head 4	300		
		5977002 Label printer SQUIX 4/600	5977380.001	Print head 4	600		
		5977016 Label printer SQUIX 4.3/200P	5977382.001	Print head 4.3	200	5954180.001 5954985.001 5954183.001	Print roller DR4 Print roller DRS4 Rewind assist roller RR4
		5977017 Label printer SQUIX 4.3/300P	5977383.001	Print head 4.3	300		
		5977004 Label printer SQUIX 4/300P	5977444.001	Print head 4	300		
		5977005 Label printer SQUIX 4/600P	5977380.001	Print head 4	600		
1.3		5977034 Label printer SQUIX 6.3/200	5977386.001	Print head 6.3	200	5954245.001 5954979.001	Print roller DR6 Print roller DRS6
		5977035 Label printer SQUIX 6.3/300	5977387.001	Print head 6.3	300		
		5977036 Label printer SQUIX 6.3/200P	5977386.001	Print head 6.3	200	5954245.001 5954979.001 5954246.001	Print roller DR6 Print roller DRS6 Rewind assist roller RR6
		5977037 Label printer SQUIX 6.3/300P	5977387.001	Print head 6.3	300		
Pos.	Part no.	Printers with a centered material guide	Part no.	Print heads	dpi	Part no.	Wear parts
1.4		5977018 Label printer SQUIX 4.3/200M	5977382.001	Print head 4.3	200	5954180.001 5954985.001 5953700.001 5953701.001 5953702.001	Print roller DR4 Print roller DRS4 Print roller DR4-M25 Print roller DR4-M50 Print roller DR4-M80
		5977019 Label printer SQUIX 4.3/300M	5977383.001	Print head 4.3	300		
		5977010 Label printer SQUIX 4/300M	5977444.001	Print head 4	300		
		5977011 Label printer SQUIX 4/600M	5977380.001	Print head 4	600		
		5977022 Label printer SQUIX 4.3/200MP	5977382.001	Print head 4.3	200	5954180.001 5954985.001 5953700.001 5953701.001 5953702.001 5954183.001	Print roller DR4 Print roller DRS4 Print roller DR4-M25 Print roller DR4-M50 Print roller DR4-M80 Rewind assist roller RR4
		5977023 Label printer SQUIX 4.3/300MP	5977383.001	Print head 4.3	300		
		5977007 Label printer SQUIX 4/300MP	5977444.001	Print head 4	300		
		5977008 Label printer SQUIX 4/600MP	5977380.001	Print head 4	600		
1.5		5977024 Label printer SQUIX 4.3/300MT	5977383.001	Print head 4.3	300	5954180.001 5954985.001 5953700.001 5953701.001 5953702.001	Print roller DR4 Print roller DRS4 Print roller DR4-M25 Print roller DR4-M50 Print roller DR4-M80
		5977012 Label printer SQUIX 4/300MT	5977444.001	Print head 4	300		
		5977025 Label printer SQUIX 4/600MT	5977380.001	Print head 4	600		

Pos.	Part no.	Special printers
1.8	5977xxx.124	Printers with a conductive ESD surface
		Label printer SQUIX x/xxx-ESD "x" - choose device from Pos. 1.1-1.5
1.9	5977xxx.122	Printers with a hinged cover for food applications
		Label printer SQUIX x/xxx-FOOD "x" - choose device from Pos. 1.1-1.5

x - user specific part no. following request

Scope of delivery:
<p>Label printer Power cable Type E+F, length 1.8 m Connecting cable USB, length 1.8 m USB WLAN stick 2.4 GHz 802.11b/g/n Operator's manual DE/EN</p>
<p>DVD:</p> <p>Operator's manual in 30 languages Configuration manual DE/EN/FR Service manual DE/EN Spare parts list DE/EN Programming manual EN WHQL certified Windows printer drivers for <ul style="list-style-type: none"> Windows Vista Server 2008 Windows 7 Server 2008 R2 Windows 8 Server 2012 Windows 8.1 Server 2012 R2 Windows 10 Server 2016 Server 2019 </p> <p>Apple Mac OS X printer drivers DE/EN/FR Linux printer drivers DE/EN/FR Label software cablabel S3 Lite cablabel S3 Viewer Database Connector</p>







Delivery program accessories

Pos.	Part no.	
2.1		6010186 External operation panel
		5907718 Connecting cable USB, length 1,8 m
		5907730 Connecting cable USB, length 3 m
	5907750 Connecting cable USB, length 5 m	
2.3		5977797 Antistatic brush 2" 5977339 Antistatic brush 4" / 6"
2.6		5959622 Adapter 100
2.7		5977370 SD memory card 8 GB
2.8		5977730 USB memory stick 8 GB
2.9		5977731 USB WLAN stick with rod antenna 2.4 GHz 802.11b/g/n + 5 GHz a/n/ac
2.10		5977732 USB Bluetooth adapter
2.11		5978911.597 Barcode tester CC100 for linear and 2D barcodes
Pos.	Part no.	Label peel-off
2.12		5977585 Present sensor PS800
2.13		5984482 Present sensor PS 2/900
		5977538 Present sensor PS 4/900
2.14		5977735 Present sensor PS1000 MP
2.15		5977798 Extended peel-off plate DP210
		5978908 Extended peel-off plate DP410
		5977799 Extended peel-off plate DP610
2.16		5978909 Product sensor with reflector
Pos.	Part no.	Interfaces, switches
3.1		5977767 Digital I/O interface
3.2		5917651 I/O interface connector SUB-D 25 pin
3.3		5948205 Label selection - I/O box
3.4		5955710 Hand switch TR2
3.5		5955711 Foot switch





Pos.	Part no.	Connecting cable
4.1		5550818 Connecting cable RS232 C 9/9 pin, length 3 m
Pos.	Part no.	Label cutting, perforating, stacking
5.1		5979032 Cutter CU200
		5978900 Cutter CU400
		5979033 Cutter CU600
5.2		5978901 Perforation cutter PCU400/2,5
		5978920 Perforation cutter PCU400/10
5.3		5978902 Stacker with cutter and base frame ST400 M
		
Pos.	Part no.	Label rewinding, unwinding
6.1		5979031 Rewind guide plate RG200
		5978903 Rewind guide plate RG400
6.3		5948102.597 External rewinder ER1/210
		5943251.597 External rewinder ER2/210
6.5		5946090 External rewinder ER4/300
		5946420 External rewinder ER6/300
6.6		5946091 External unwinder EU4/300
		5946421 External unwinder EU6/300
6.7		5978943 Adapter kit for ER4, ER6 and EU4, EU6

x - user specific part no. following request

Delivery program accessories

Pos.		Part no.	Applicators, demand modules
7.1		5976086 5976087 5976088	Applicator S1000-220 Applicator S1000-300 Applicator S1000-400
7.2		5949072	Universal pad A1021 70x60
		5949075	Universal pad A1021 90x90
		59xxxxx	Tamp pad A1021 WxH
7.3		5949076	Universal pad A1321 116x102
		5949077	Universal pad A1321 116x152
		59xxxxx	Tamp pad A1321 WxH
7.4		59xxxxx	Blow pad A2021 WxH
7.5		59xxxxx	Roll-on pad A1411 WxH
7.6		5976085	Applicator S3200
7.7		59xxxxx	Tamp pad A3200-1100 WxH
7.8		59xxxxx	Blow pad A3200-2100 WxH
7.9		5976083 5979035	Demand module S5104 Demand module S5106
7.10		5976084	All-around labeler

x - user specific part no. following request

Pos.		Part no.	Mounting equipment
8.1		5979036 5978910 5978923	Mounting plate SQUIX 2 Mounting plate SQUIX 4 Mounting plate SQUIX 6
8.2		5958365 5965929 5971136	Profile 40 Profile 80 Profile 120 special lengths on request
8.3		5961203	Base plate 500x255
8.4		5947400	Floor stand 1600
8.5		5979037 5978922 5979038	Printer holder SQUIX 2 Printer holder SQUIX 4 Printer holder SQUIX 6
Pos.		Part no.	Special covers
9.2		5977773.001 5977764.001 5977774.001	Hinged cover SQUIX 2-FOOD Hinged cover SQUIX 4-FOOD Hinged cover SQUIX 6-FOOD
Pos.		Part no.	Protection chassis
9.3		5979071 5979305	Stainless steel chassis SQUIX 4 Stainless steel chassis SQUIX 6
9.4		5979080 5979300	Dust protection chassis SQUIX 4 220 V Dust protection chassis SQUIX 6 220 V
		5979080.126 5979300.126	Protection chassis cleanroom SQUIX 4 Protection chassis cleanroom SQUIX 6
Pos.		Part no.	Label software
11.7		Freeware	cablabel S3 Lite (Download at cab.de/en)
		5588001 5588100 5588101 5588150 5588151 5588152	cablabel S3 Pro 1 WS cablabel S3 Pro 5 WS cablabel S3 Pro 10 WS cablabel S3 Pro 1 additional licence cablabel S3 Pro 4 additional licences cablabel S3 Pro 9 additional licences
11.10		5588002 5588105 5588106 5588155 5588156 5588157	cablabel S3 Print 1 WS cablabel S3 Print 5 WS cablabel S3 Print 10 WS cablabel S3 Print 1 additional licence cablabel S3 Print 4 additional licences cablabel S3 Print 9 additional licences
		in preparation	cablabel S3 Print Server
11.10		9009950	Programming manual EN, printed copy

cab product overview

Label printers MACH1, MACH2
in the lower price segment



Label printers MACH 4S
where little space is available



Label printers EOS2
Desktop device for label rolls up to diameter 152 mm



Label printers EOS5
Desktop device for label rolls up to diameter 203 mm



Label printers SQUIX 2
Industrial device for print widths up to 57 mm



Label printers SQUIX 4
Industrial device for print widths up to 108 mm



Label printers SQUIX 6.3
Industrial device for print widths up to 168 mm



Label printers A8+
Industrial device for print widths up to 216 mm



Label printers XD4T
for double-sided printing



Label printers XC
for two-color printing



Print and apply systems HERMES Q
for automation



Print and apply systems Hermes C
for two-color printing and applying

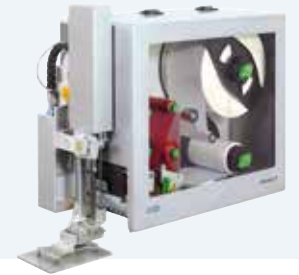

Print modules PX
to be integrated in labeling machines



Labels
made from more than 400 materials



Ribbons
in wax, resin and resin/wax qualities



Label software cablabel S3
Design, print, control



Label dispensers HS, VS
for horizontal or vertical dispense



Labeling heads IXOR
to be integrated in labeling machines



Marking lasers XENO 4
in 19" housings



Laser marking systems
in desktop housings



Germany
cab Produkttechnik GmbH & Co KG
Karlsruhe
Phone +49 721 6626 0
www.cab.de

France
cab Technologies S.à.r.l.
Niedermodern
Phone +33 388 722501
www.cab.de/fr

USA
cab Technology, Inc.
Chelmsford, MA
Phone +1 978 250 8321
www.cab.de/us

Mexico
cab Technology, Inc.
Juárez
Phone +52 656 682 4301
www.cab.de/es

Taiwan
cab Technology Co., Ltd.
Taipei
Phone +886 (02) 8227 3966
www.cab.de/tw

China
cab (Shanghai) Trading Co., Ltd.
Shanghai
Phone +86 (021) 6236 3161
www.cab.de/cn

China
cab (Shanghai) Trading Co., Ltd.
Guangzhou
Phone +86 (020) 2831 7358
www.cab.de/cn

South Africa
cab Technology (Pty) Ltd.
Randburg
Phone +27 11 886 3580
www.cab.de/za

cab // 820 distribution partners in more than 80 countries

cab
we identify more