



DS2400A Laser Barcode Reader Quick Reference Guide



Figure A

- | | |
|--------------------------|----------------------------------|
| ① Power On / Data TX LED | ⑤ Warning and Device Class Label |
| ② External Trigger LED | ⑥ Laser Beam Output Window |
| ③ Good Read LED | ⑦ Accessory Mounting Holes |
| ④ Laser On LED | ⑧ Mounting Holes |

For further details on product installation, see the complete Reference Manual.

DS2400A can be configured through the WinHost Windows-based software program available on the installation CD-ROM.

For configuration it is necessary to create a cable connecting the scanner to the PC as indicated in the "How To Build A Simple Interface Test Cable" section of this guide, otherwise you can use the C-Box 100.

POWER SUPPLY

- This product is intended to be installed by Qualified Personnel only.
- **All Models:**
This accessory device is intended to be supplied by a UL Listed or CSA Certified Power Unit with «Class 2» or LPS power source which supplies power directly to the scanner via the 25-pin connector.

The scanner is classified as a Class 2 laser product according to EN 60825-1 regulations and as a Class II laser product according to CDRH regulations.

Disconnect the power supply when opening the device during maintenance or installation to avoid exposure to hazardous laser light.

There is a safety device which allows the laser to be switched on only if the motor is rotating above the threshold for its correct scanning speed.

The motor and laser beam can be switched off through a software command (see also the WinHost Help On Line).

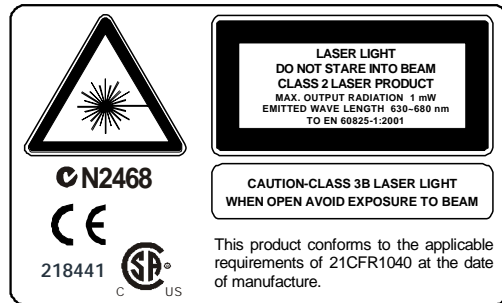

Warning and Device Class Labels

The laser diode used in this device is classified as a class 3B laser product according to EN 60825-1 regulations and as a Class IIIb laser product according to CDRH regulations. As it is not possible to apply a classification label on the laser diode used in this device, the following label is reproduced below.

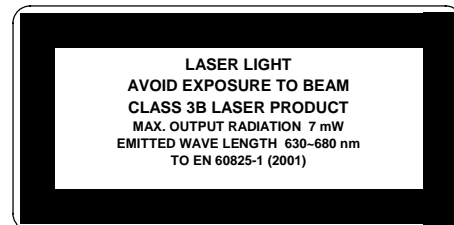

Laser Diode Class Label

Any violation of the optic parts in particular can cause radiation up to the maximum level of the laser diode (7 mW at 630 to 680 nm).

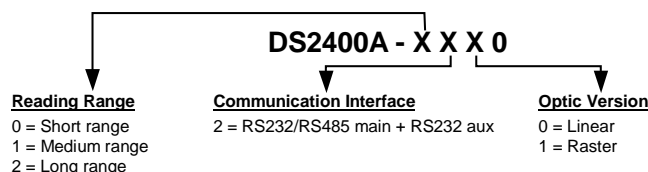
Model Description:

Reading Performance:

Version	Reading Distance	Max Code Resolution mm (mils)	Speed scans/s
0XX0	75 mm (3 in) - 340 mm (13.4 in) on 0.35 mm (14 mils) codes	0.20 (8)	600 to 1000
1XX0	100 mm (3.9 in) - 440 mm (17.3 in) on 0.50 mm (20 mils) codes	0.25 (10)	600 to 1000
2XX0	190 mm (7.5 in) - 600 mm (23.6 in) on 0.50 mm (20 mils) codes	0.35 (14)	600 to 1000

Technical Features:

ELECTRICAL FEATURES		SOFTWARE FEATURES	
Power Supply	10 –30 Vdc	Readable Codes * EAN/UPC (including Add-on 2 and Add-on 5) * Code 39 * 2/5 Interleaved * Code 128 * EAN 128 * Codabar * Code 93 ISBT 128 Pharmacode * = ACB readable	
Power Consumption	5 W maximum		
Main Serial Interface	Programmable: RS232; RS485 Full-Duplex/Half-Duplex;		
Auxiliary Interface	RS232		
Baudrates	150 to 115200		
Inputs			
External Trigger	(optocoupled NPN or PNP)		
Voltage max.	30 Vdc		
Current Consumption max.	25 mA		
Outputs) OUT1, OUT2	(optocoupled)		
V_{CE} max.	40 Vdc	Headers and Terminators	Up to four header and four terminator characters
Collector Current max.	40 mA continuous; 130 mA pulsed	Operating Modes	On-Line, Automatic, Serial-On-Line, Test
V_{CE} Saturation	1V at 10 mA max.	Configuration Modes	Through menus using: WinHost utility Host Mode (commands from one of the serial ports)
Power Dissipation max.	90 mW at 40 °C (Ambient temp.)	Code Selection	Up to six different codes during one reading phase
OPTICAL FEATURES		Decoding Safety	Can enable multiple good reads of the same code
Light Source	semiconductor laser diode	Special Functions	ACB (Advanced Code Builder) Motor Off
Wavelength	In the range 630 to 680 nm	Parameter Storage	Non-volatile internal EEPROM
Safety Class	Class 2 - EN 60825-1; CDRH	ENVIRONMENTAL FEATURES	
USER INTERFACE		Operating Temperature	0° to +40 °C (+32° to +104 °F)
LED Indicators	Laser ON, Good Read, External Trigger, Data TX / Power ON	Storage Temperature	-20° to +70 °C (-4° to +158 °F)
PHYSICAL FEATURES		Humidity max	90% non condensing
Dimensions	68x83.6x34 mm (2.7x3.29x1.3 in)	Vibration Resistance	IEC 68-2-6 test FC 1.5 mm; 10 to 55 Hz; 2 hours on each axis
Weight	330 g. (11.64 oz)	Shock Resistance	IEC 68-2-27 test EA 30 G; 11 ms; 3 shocks on each axis
		Protection Class	IP65

Accessories:

Name	Description	Part Number
GFC-2100	90° Reading Device	93A201000
GFC-2000	105° Reading Device	93A201080
INT-30 (for C-Box 100)	20 mA Current Loop Interface Board	93A151022
C-BOX 100/200	Connection Box	93ACC1510, 93ACC1520
C-BOX 300/310	Connection Box Profibus	93A301000, 93A301030
C-BOX 400/410	Connection Box DeviceNet	93A301010, 93A301040
MEP-542/543	Photocell Kit NPN/PNP	93ACC1727, 93ACC1728

Electrical Connections:

DS2400A is equipped with a cable terminated by a 25-pin female D-sub connector for connection to the power supply, communication interface and input/output signals. You can bring system cables directly to the 25-pin connector or you can connect the scanner directly to one of the various C-Box models and bring system wiring to it (see the relative C-Box Installation Manual).



CAUTION Do not connect GND and SGND to different (external) ground references. GND and SGND are internally connected through filtering circuitry which can be permanently damaged if subjected to voltage drops over 0.8 Vdc.

The details of the connector pins are indicated in the following table:

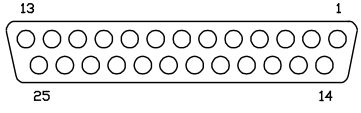
25-pin D-sub female connector pinout			
Pin	Name	Function	
13	VS	Power supply input voltage +	 <p style="text-align: center;">25-pin female connector</p>
25	GND	Power supply input voltage -	
1	CHASSIS	Chassis Ground	
9	VS	External Trigger supply voltage +	
18	EXT TRIG+	External Trigger +	
19	EXT TRIG-	External Trigger -	
8	OUT1 +	Output 1 +	
11	OUT2 +	Output 2 +	
12, 22	OUT REF	Output reference	
20	RXAUX	Auxiliary RS232	
21	TXAUX	Auxiliary RS232	
23	CTSAUX	Auxiliary handshake RS232	
24	RTSAUX	Auxiliary handshake RS232	
6, 10, 14, 15, 16, 17	NC	Not Connected	
Pin	RS232	RS485 Full-Duplex	RS485 Half-Duplex
2	TX232	TX485+	RTX485+
3	RX232	RX485+	
4	RTS232	TX485-	RTX485-
5	CTS232	RX485-	
7	SGND	SGND	SGND

Mechanical Installation:

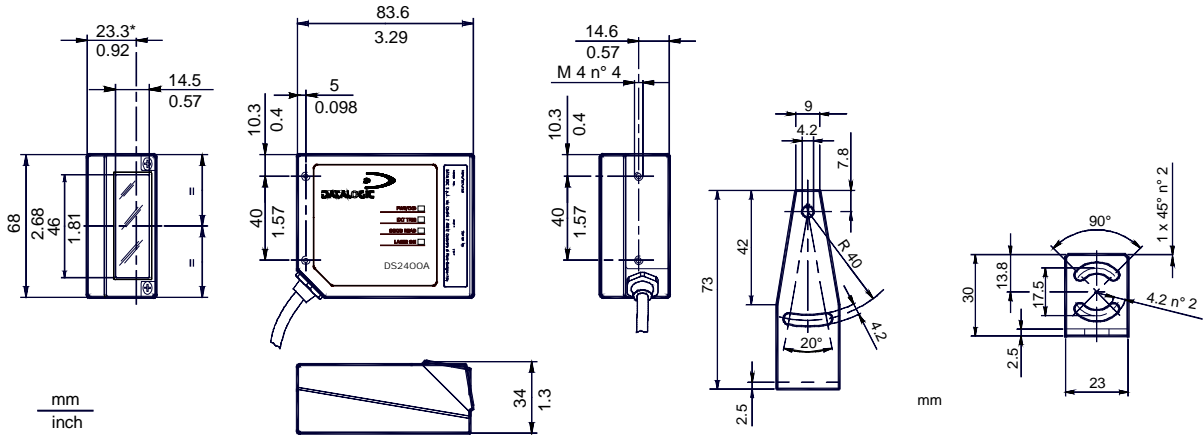

* The quote refers to the scan line

Input/Output Connections:

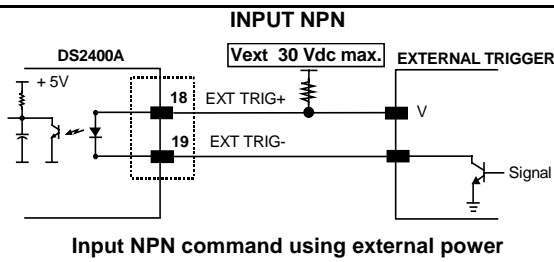

Input NPN command using external power

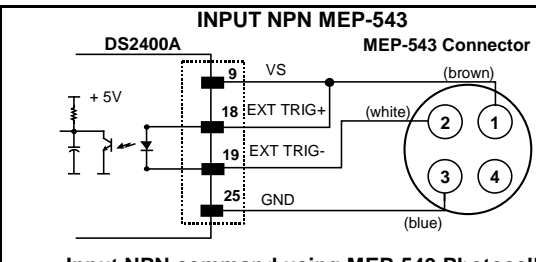

Input NPN command using MEP-543 Photocell

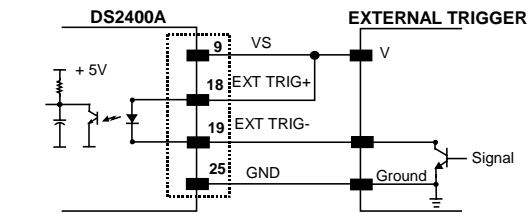

Input NPN command using DS2400A power

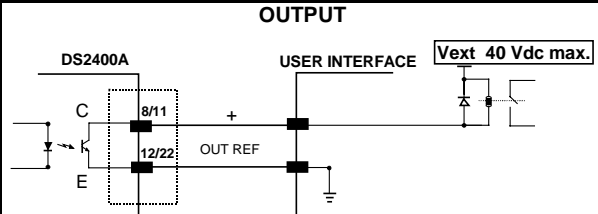

Output open collector connections

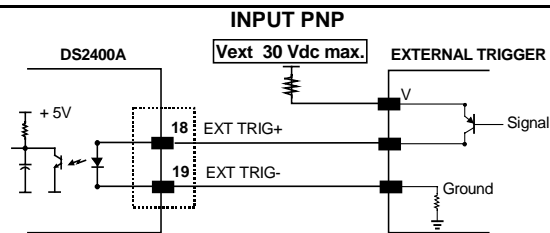

Input PNP command using external power

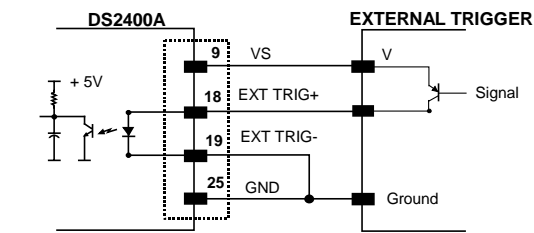

Input PNP command using DS2400A power

V_{CE} max = 40 Vdc
I max = 40 mA continuous

Connectivity:

RS232 Main Interface Connections

RS232 Point-to-point layout

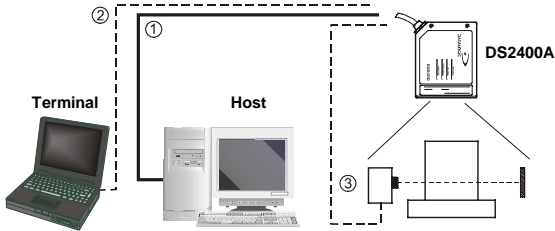

- ① Main Serial Interface (RS232)
- ② Auxiliary Serial Interface (Local Echo) (RS232)
- ③ External Trigger (for On-Line Mode)

Pass-through layout

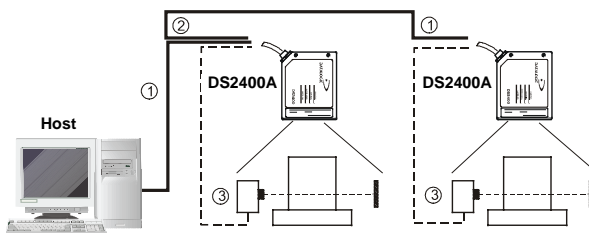

- ① Main Serial Interface (RS232)
- ② Auxiliary Serial Interface (RS232)
- ③ External Trigger (for On-Line Mode)

RS232 Master/slave layout

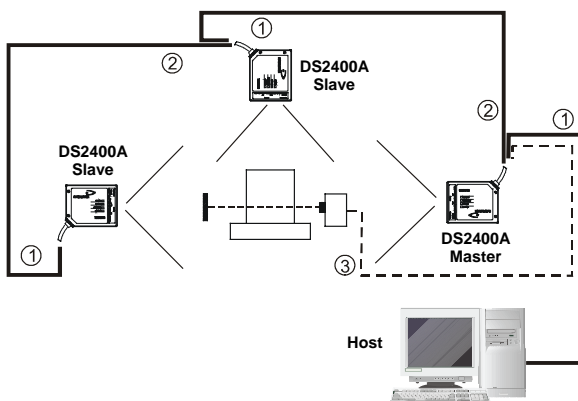

- ① Main Serial Interface (Slaves RS232 only)
- ② Auxiliary Serial Interface (RS232)
- ③ External Trigger (for On-Line Mode)

RS485 Main Interface Connections

RS485 Point-to-point layout

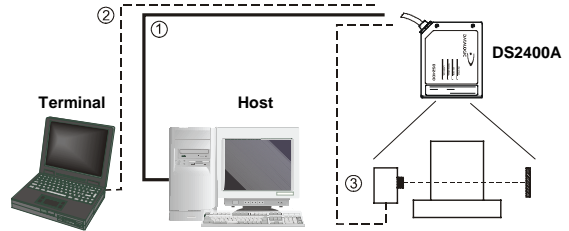

- ① Main Serial Interface (RS485 Full Duplex)
- ② Auxiliary Serial Interface (Local Echo) (RS232)
- ③ External Trigger (for On-Line Mode)

Multiplexer layout

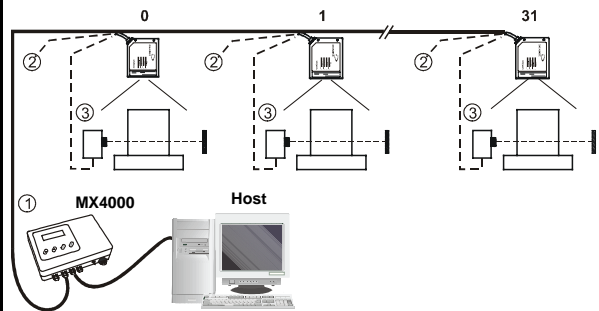

- ① Main Serial Interface (RS485 Half-Duplex)
- ② Auxiliary Serial Interface (Local Echo) (RS232)
- ③ External Trigger (for On-Line Mode)

RS485 Master/slave layout

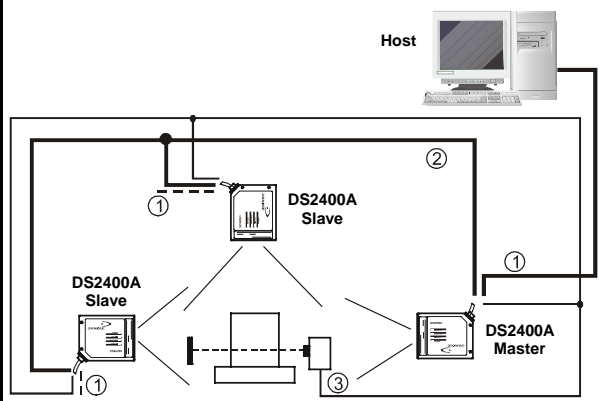

- ① Auxiliary Serial Interface (RS232)
- ② Main Serial Interface (RS485 Half-Duplex)
- ③ External Trigger

Reading Diagrams:

DS2400A-0200 (Short Reading Range)

CONDITIONS

- Optic Version = Linear
- Code = Interleaved 2/5 or Code 39
- PCS = 0.90
- Pitch angle = 0°
- Skew angle = 10°
- Tilt angle = 0°
- * Code Resolution = High
- * Code Reading Condition = Standard
- * Scanning Speed = Speed_3 (800 scans/s)

* Parameters selectable in WinHost.

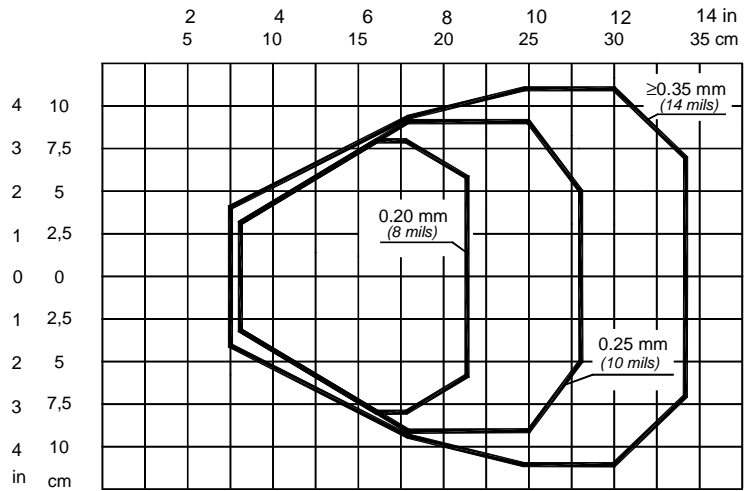

DS2400A-1200 (Medium Reading Range)

CONDITIONS

- Optic Version = Linear
- Code = Interleaved 2/5 or Code 39
- PCS = 0.90
- Pitch angle = 0°
- Skew angle = 10°
- Tilt angle = 0°
- * Code Resolution:
 - High – for 0.25 mm (10 mils) codes
 - Std – for 0.35 mm (14 mils) codes and greater
- * Code Reading Condition = Standard
- * Scanning Speed = Speed_3 (800 scans/s)

* Parameters selectable in WinHost.

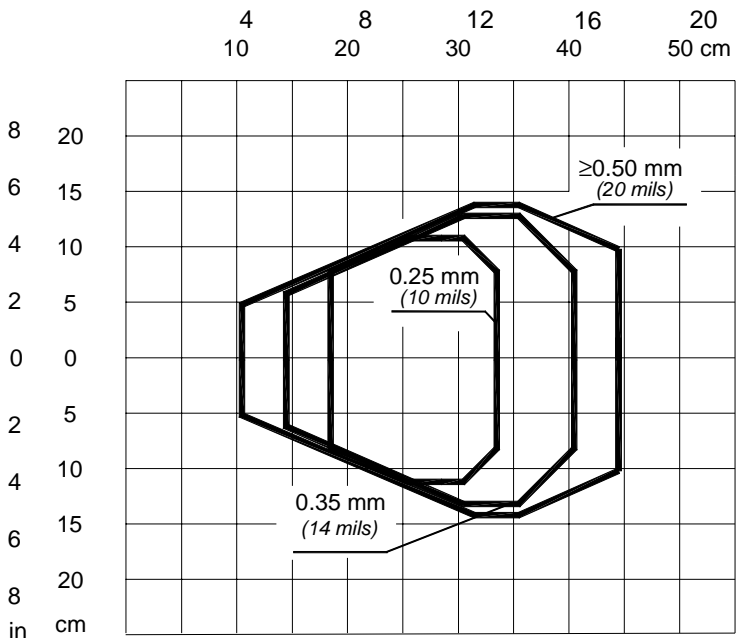

DS2400A-2200 (Long Reading Range)

4	8	12	16	20	24	28 in
10	20	30	40	50	60	70 cm

CONDITIONS

- Optic Version = Linear
- Code = Interleaved 2/5 or Code 39
- PCS = 0.90
- Pitch angle = 0°
- Skew angle = 10°
- Tilt angle = 0°
- * Code Resolution:
 - High – for 0.35 mm (14 mils) codes
 - Std – for 0.50 mm (20 mils) codes and greater
- * Code Reading Condition = Standard
- * Scanning Speed = Speed_3 (800 scans/s)

* Parameters selectable in WinHost.

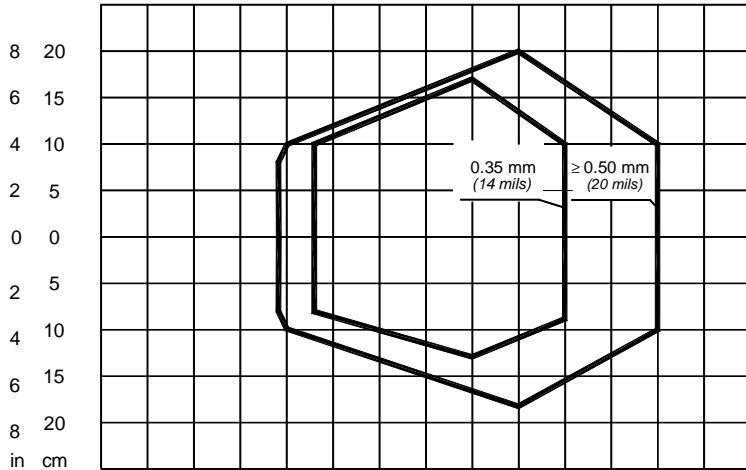

User Interface:

The following table contains the pinout for standard RS232 PC Host interface. For other user interface types please refer to their own manual.

RS232 PC-side connections			
<p>9-pin male connector</p>		<p>25-pin male connector</p>	
Pin	Name	Pin	Name
2	RX	3	RX
3	TX	2	TX
5	GND	7	GND
7	RTS	4	RTS
8	CTS	5	CTS

How To Build A Simple Interface Test Cable:

The following wiring diagram shows a simple test cable including power, external (push-button) trigger and PC RS232 COM port connections.

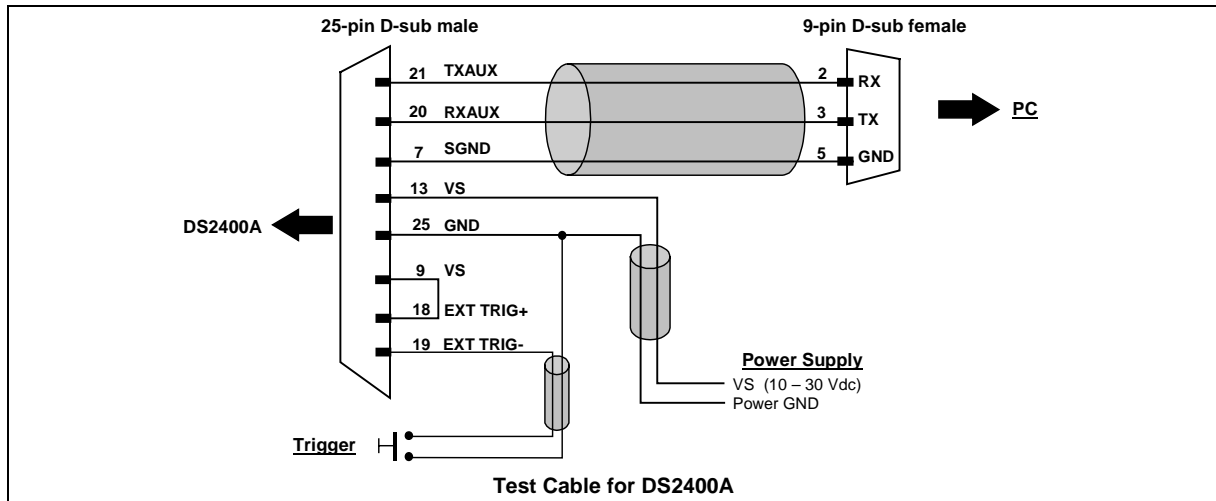



dichiara che
declares that the
déclare que le
bescheinigt, daß das Gerät
declare que el

DS2400A-XXXX Laser Scanner e tutti i suoi modelli
and all its models
et tous ses modèles
und seine modelle
y todos sus modelos

sono conformi alle Direttive del Consiglio Europeo sottoelencate:
are in conformity with the requirements of the European Council Directives listed below:
sont conformes aux spécifications des Directives de l'Union Européenne ci-dessous:
der nachstehend angeführten Direktiven des Europäischen Rats:
cumple con los requisitos de las Directivas del Consejo Europeo, según la lista siguiente:

89/336/EEC EMC Directive e **92/31/EEC, 93/68/EEC** emendamenti successivi
and further amendments
et ses successifs amendements
und späteren Abänderungen
y sucesivas enmiendas

Basate sulle legislazioni degli Stati membri in relazione alla compatibilità elettromagnetica ed alla sicurezza dei prodotti.
On the approximation of the laws of Member States relating to electromagnetic compatibility and product safety.
Basée sur la législation des Etats membres relative à la compatibilité électromagnétique et à la sécurité des produits.
Über die Annäherung der Gesetze der Mitgliedsstaaten in bezug auf elektromagnetische Verträglichkeit und Produktsicherheit entsprechen.
Basado en la aproximación de las leyes de los Países Miembros respecto a la compatibilidad electromagnética y las Medidas de seguridad relativas al producto.

Questa dichiarazione è basata sulla conformità dei prodotti alle norme seguenti:
This declaration is based upon compliance of the products to the following standards:
Cette déclaration repose sur la conformité des produits aux normes suivantes:
Diese Erklärung basiert darauf, daß das Produkt den folgenden Normen entspricht:
Esta declaración se basa en el cumplimiento de los productos con las siguientes normas:

EN 55022, August 1994: LIMITS AND METHODS OF MEASUREMENTS OF RADIO DISTURBANCE CHARACTERISTICS OF INFORMATION TECHNOLOGY EQUIPMENT (ITE)

EN 61000-6-2, April 1999: ELECTROMAGNETIC COMPATIBILITY (EMC).
PART 6-2: GENERIC STANDARDS - IMMUNITY FOR INDUSTRIAL ENVIRONMENTS

Lippo di Calderara, 24/02/2004

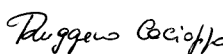
Ruggero Cacioppo
Quality Assurance Supervisor