



# User Manual

# **Network Interface**

---

**Rev. 1.05**

**SLP-TX400 / TX400E**  
**SLP-TX403 / TX403E**  
**SLP-TX420 / TX420E**  
**SLP-TX423 / TX423E**  
**SLP-TX220 / TX220E**  
**SLP-TX223 / TX223E**  
**SLP-DX420 / DX420E**  
**SLP-DX423 / DX423E**  
**SLP-DX220 / DX220E**  
**SLP-DX223 / DX223E**  
**SLP-DL410 / DL410E**  
**SLP-DL413 / DL413E**

## ■ Table of Contents

<b>1. Specifications.....</b>	<b>3</b>
<b>2. How to Connect.....</b>	<b>4</b>
2-1 Initial Wireless LAN Connection(Windows 2000).....	5
2-2 Initial Wireless LAN Connection(Windows XP).....	5
2-3 Initial Wireless LAN Connection(Windows VISTA, Windows 7, 8, 10) .....	10
<b>3. Configuration .....</b>	<b>16</b>
3-1 Configuration Tool.....	18
3-2 Web Browser .....	25
3-3 FTP.....	28
3-4 Telnet.....	30
<b>4. SMTP.....</b>	<b>31</b>
<b>5. Ethernet / WLAN Test by using Windows Test Page.....</b>	<b>34</b>
<b>6. Factory Reset .....</b>	<b>40</b>
<b>7. Troubleshooting.....</b>	<b>43</b>

## 1. Specifications

### (1) WLAN USB Adapter

BIXOLON printers require WLAN USB adapter to use the wireless LAN function.

WLAN USB Adapter for BIXOLON printers should be available from BIXOLON.

USB Adapter from market not BIXOLON is not guaranteed to be working properly with BIXOLON printers.

### (2) Ethernet / WLAN Protocol

Layer	Protocol
Network Layers	ARP, IP, ICMP
Transport Layers	TCP, UDP
Application Layers	DHCP, DNS Raw Print SMTP(notify printer status) HTTP, HTTPS(setting) FTP(settings) TELNET(settings)

### (3) Ethernet Security

- HTTPS(SSL2.0, SSL3.0, TLS1.0)

### (4) WLAN Security

- WEP64/128
- WPA/WPA2(TKIP/AES-CCMP) PSK
- EAP(PEAP, FAST, LEAP, TTLS)
- HTTPS(SSL2.0, SSL3.0, TLS1.0)

## 2. How to Connect

Both Ethernet and WLAN can be configured through the printer's Ethernet interface. Likewise, both Ethernet and WLAN can also be configured through the printer's WLAN interface. When you want to change the Ethernet or WLAN of the printer, the network settings of the host(PC, PDA, etc) and Ethernet or WLAN of the printer must be properly configured so that communication can be established.

### (1) Connecting Printer

#### 1) LAN

Connect the LAN cable to the printer

A direct cable or cross cable can be connected to the Hub or Host for use.

#### 2) WLAN

Connect to the AP(Access Point) configured in Infrastructure mode in order to connect to the LAN/Wireless network.

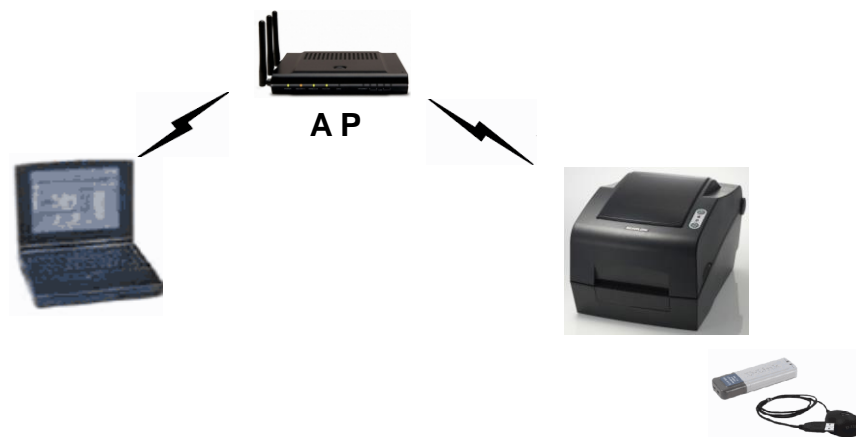

Infrastructure Mode

In order to configure the network between wireless terminals, connect to the terminal in Ad-hoc Mode.



Ad-hoc Mode

## 2-1 Initial Wireless LAN Connection(Windows 2000)

Windows 2000 does not support wireless network setting.

When you use Windows 2000, you need to set the utility option as below after installing utility program related to the wireless lan driver that you use.

- Network mode: Ad-hoc
- SSID: BIXOLON\_adhoc
- IP address: 192.168.1.2
- Subnet Mask: 255.255.255.0
- Authentication(Encryption): Open(None)

## 2-2 Initial Wireless LAN Connection(Windows XP)

When wireless utility program is installed, you have to set the wireless control values via the program, otherwise you have to terminate the program in order to do proper setting after following the steps 'Control Panel>>Administrative tools>>Services>>Wireless Zero Configuration>>Start'.



1) Right click on the  icon, and select Properties.

2) Select and right click on the Wireless Network Connection, and then select Properties.

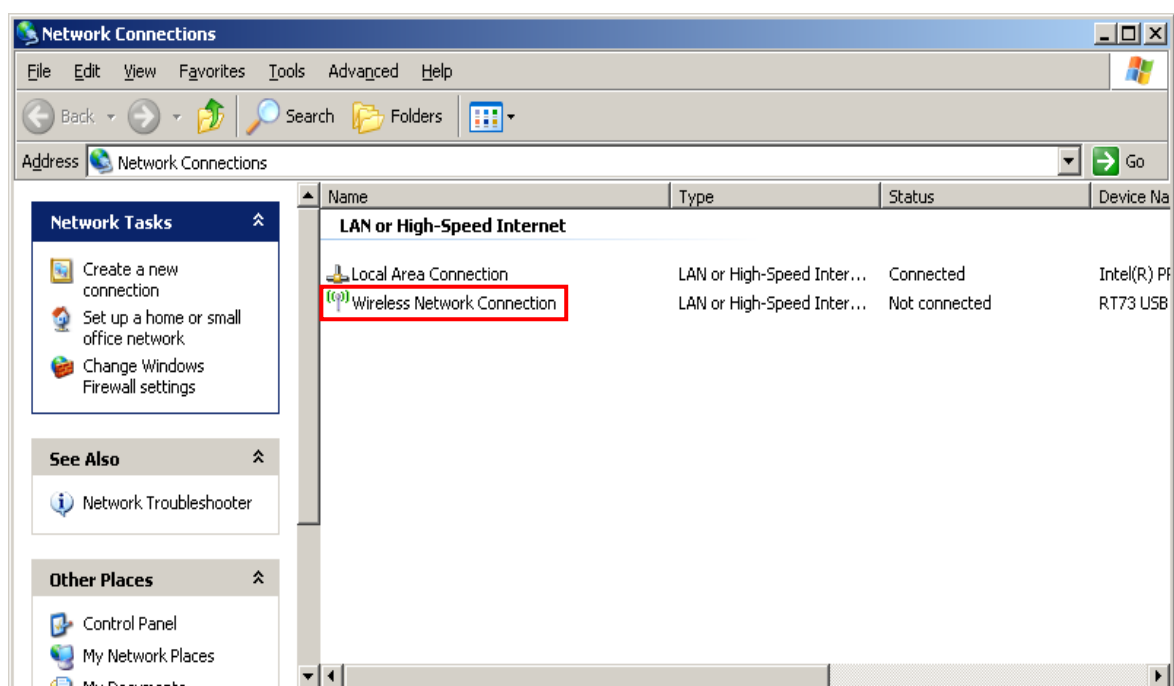

## Network Interface

3) Select Internet Protocol(TCP/IP), and then click Properties.

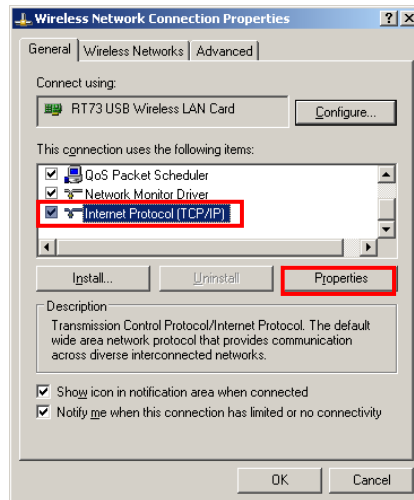

4) Set the IP settings as shown below, and then click OK.

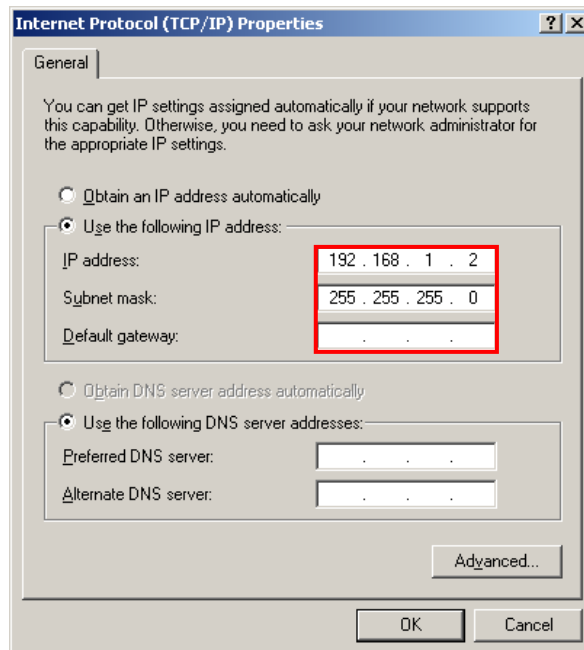

## Network Interface

- 5) Select the Wireless LAN tab, and then select “Use Windows to configure my wireless network settings.”

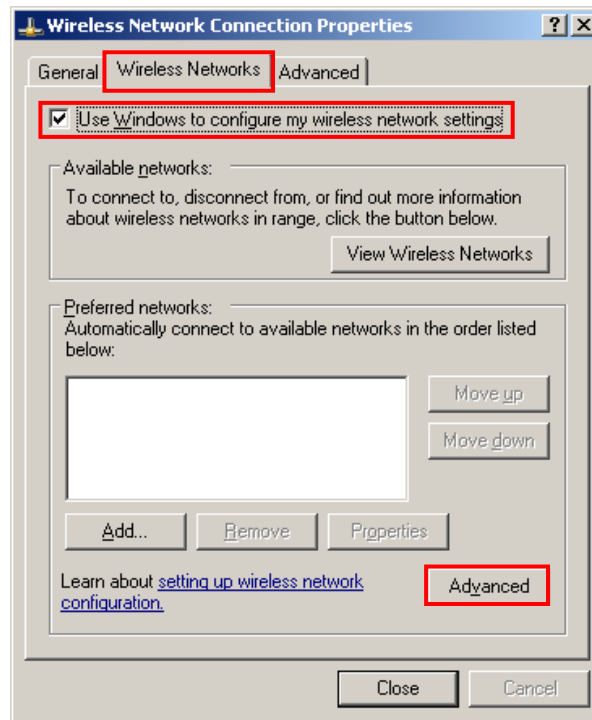

Click the [Advanced] button.

- 6) Select “Computer-to-computer(ad hoc) network only.”

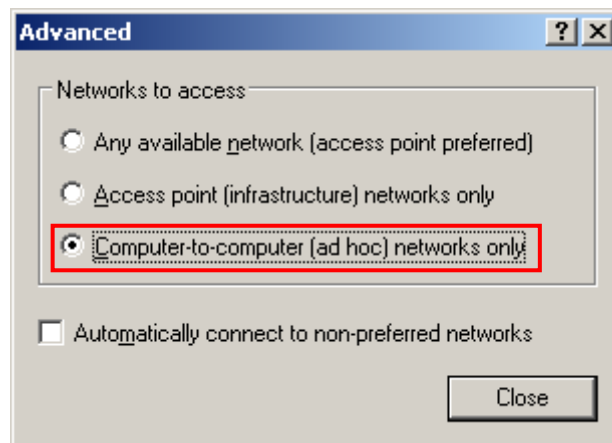

7) Click the [Add] button.

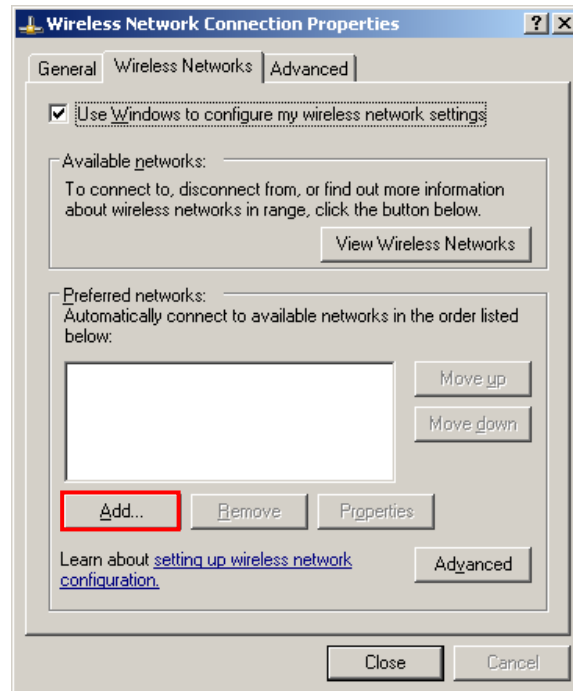

8) Enter "BIXOLON\_adhoc" as the Network name(SSID).  
Network Authentication: Select [Open]  
Data Encryption: Select [Disabled]

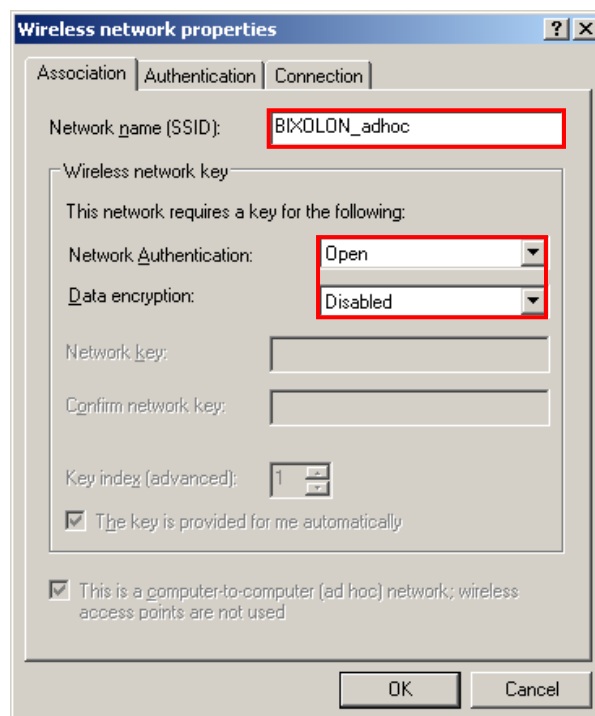

Click the [OK] button.



## Network Interface

9) Click the “Connect” tab and check “Connect when this network is in range.”

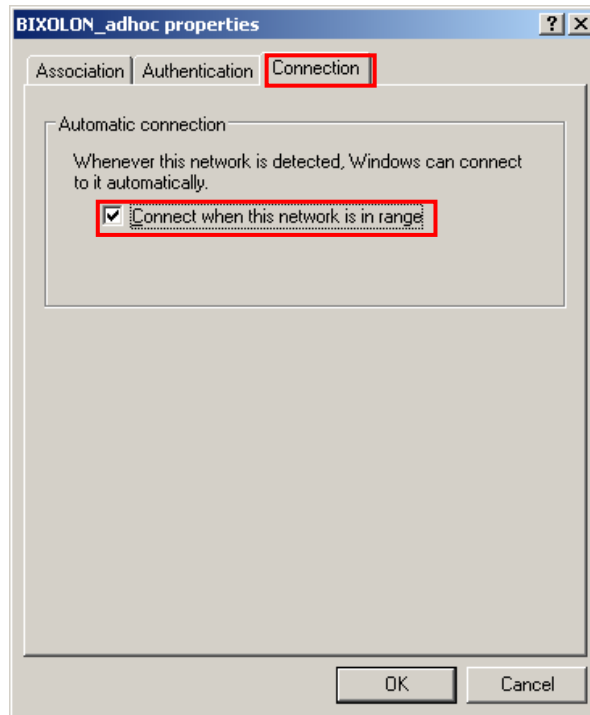

10) Check whether the settings are updated as shown below, and then click [Close]

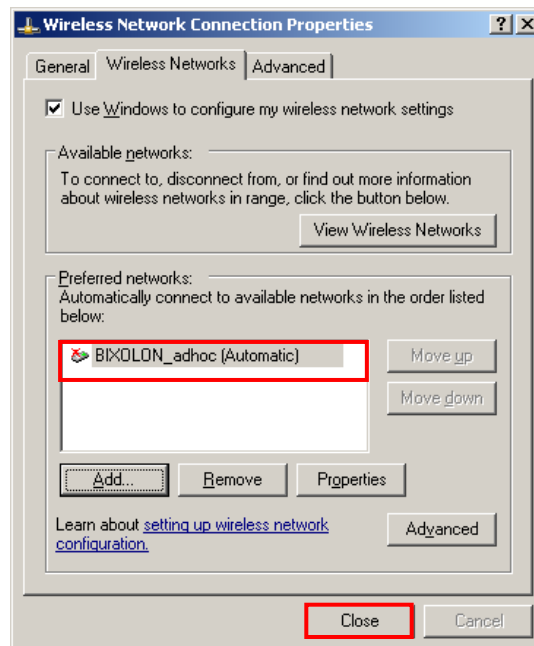

When the printer is set to the default value(Adhoc mode, SSID: BIXOLON\_adhoc), it will automatically connect.

### 2-3 Initial Wireless LAN Connection(Windows VISTA, Windows 7, 8, 10)

When wireless utility program is installed, you have to set the wireless control values via the program, otherwise you have to terminate the program in order to do proper setting after following the steps 'Control Panel>>Administrative tools>>Services>>Wireless Zero Configuration>>Start'.

1) Click the “Start>>Control Panel”.

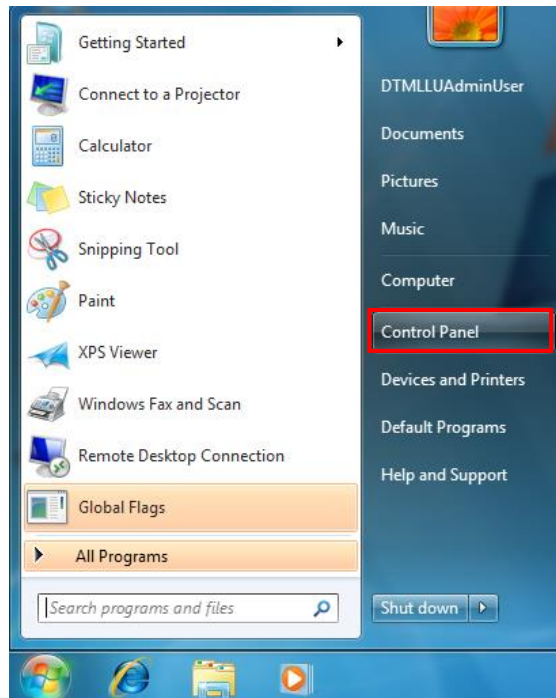

2) Click the “View network status and tasks”.

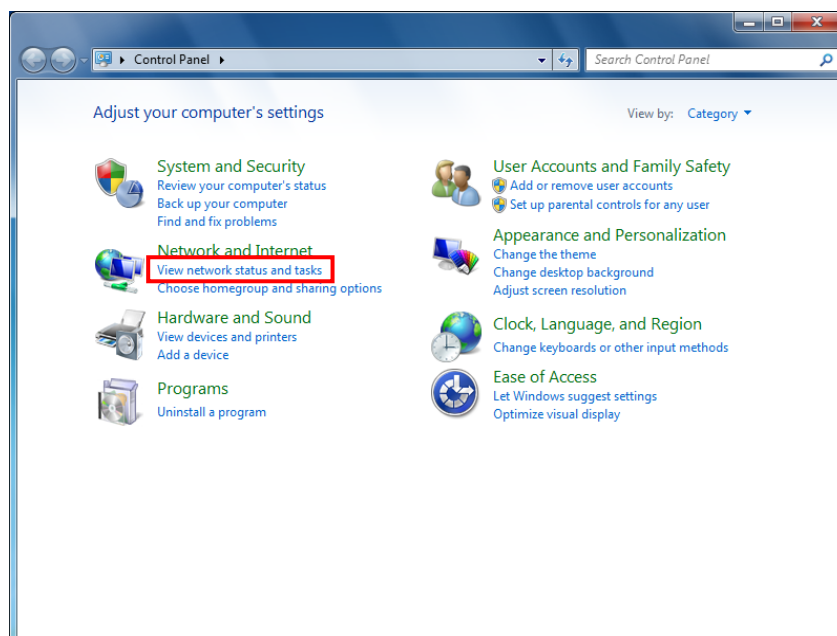

3) Click the “Change adapter settings”.

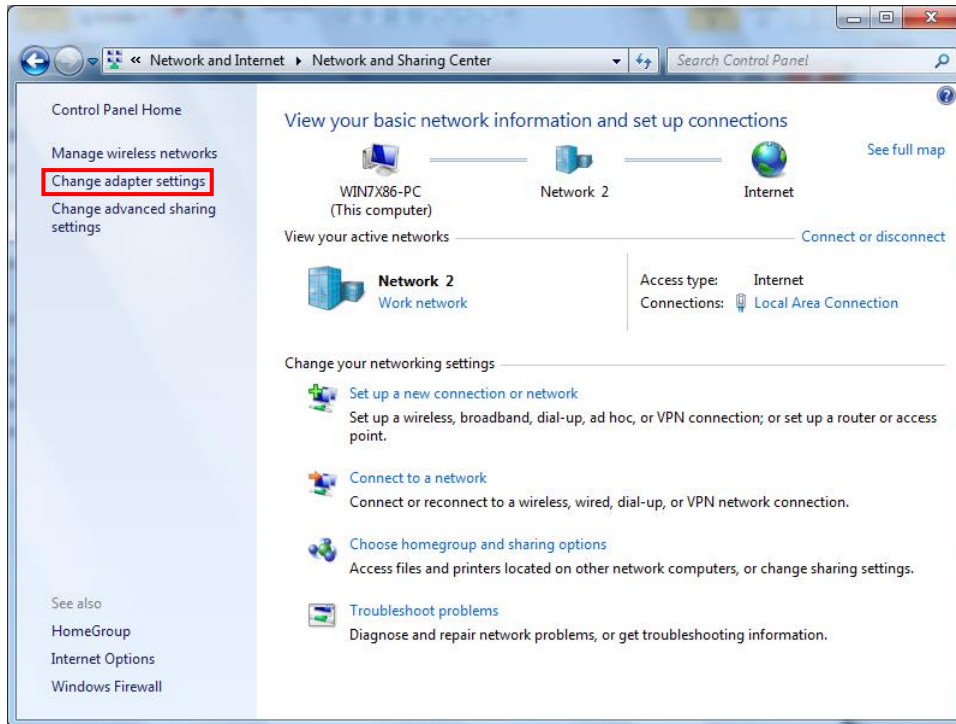

Click the “wireless network adaptor’s Properties”.

4) Select Internet Protocol Version 4(TCP/IPv4), and then click Properties.

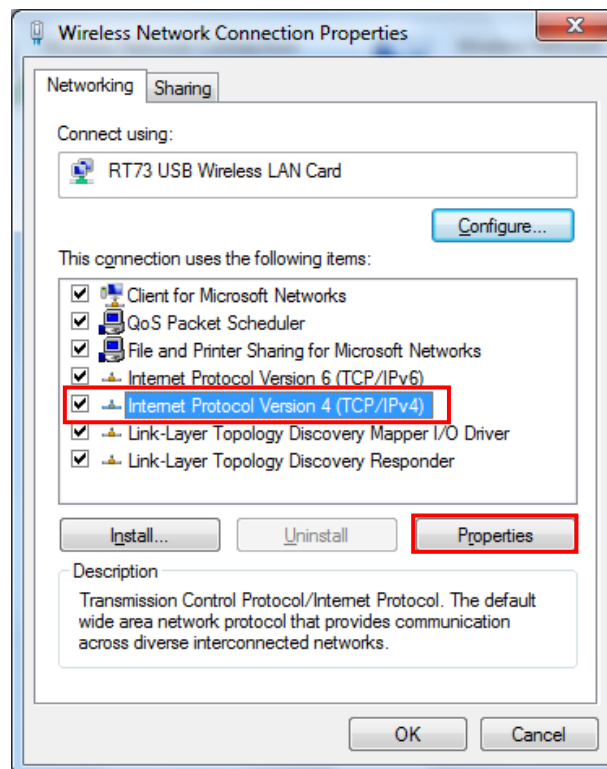

5) Set the IP settings as shown below, and then click OK.

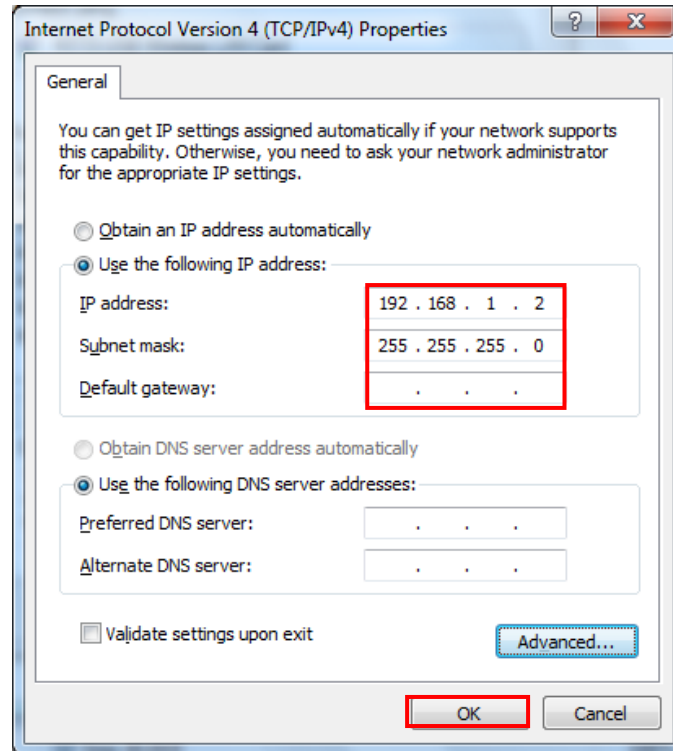

6) Click the “Manage wireless networks”.

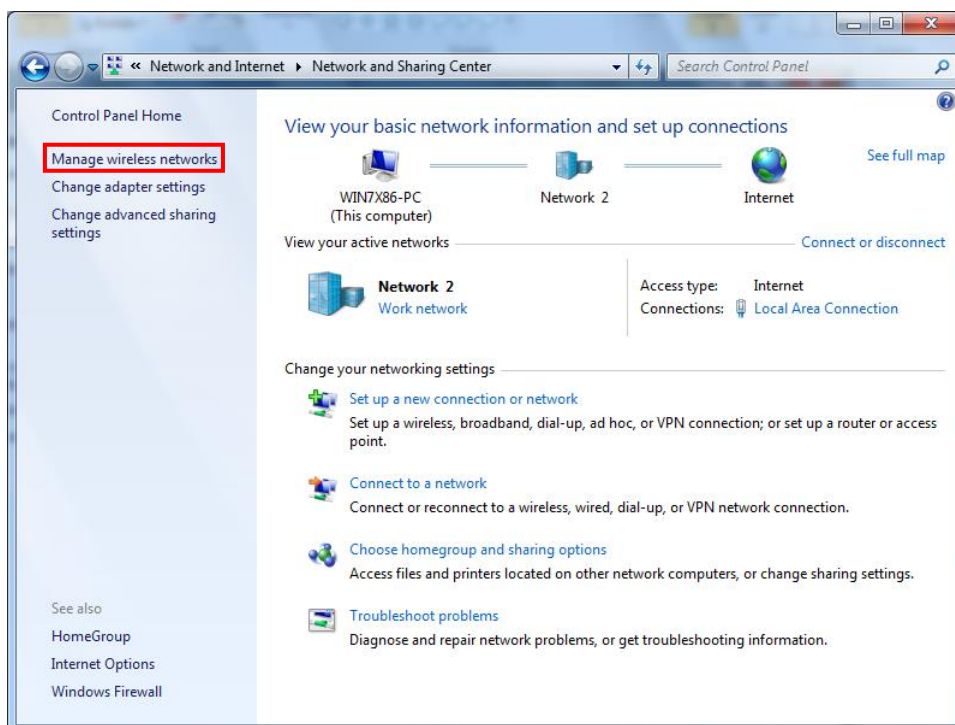

7) Click the “Add”.

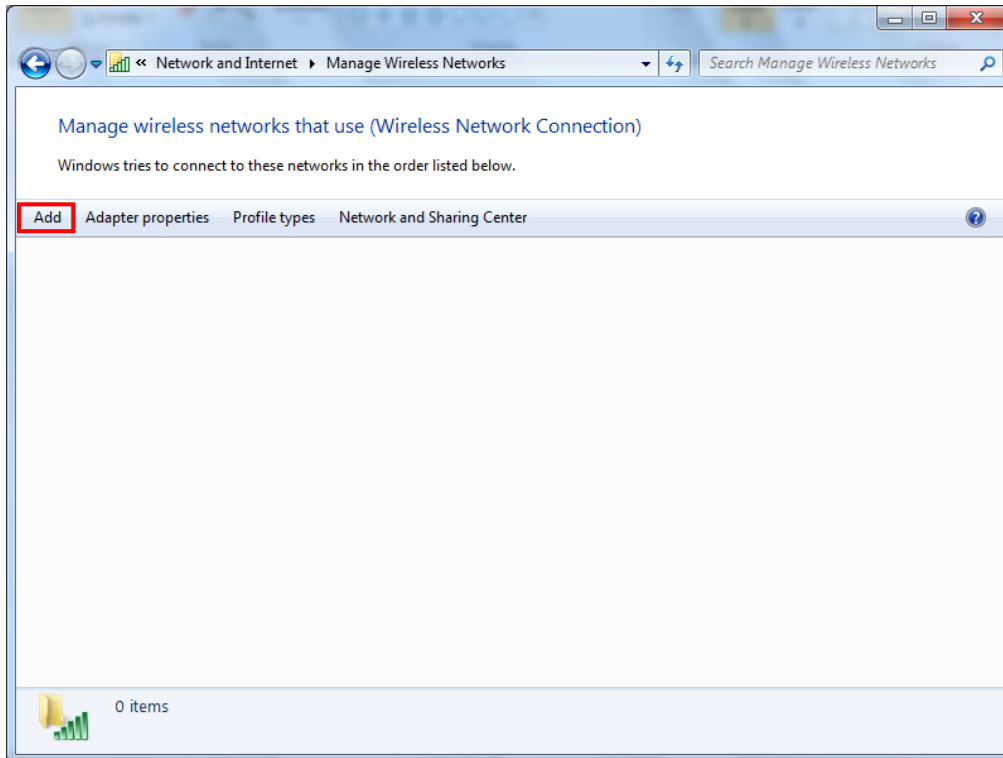

8) Click the “Create an ad hoc network”.

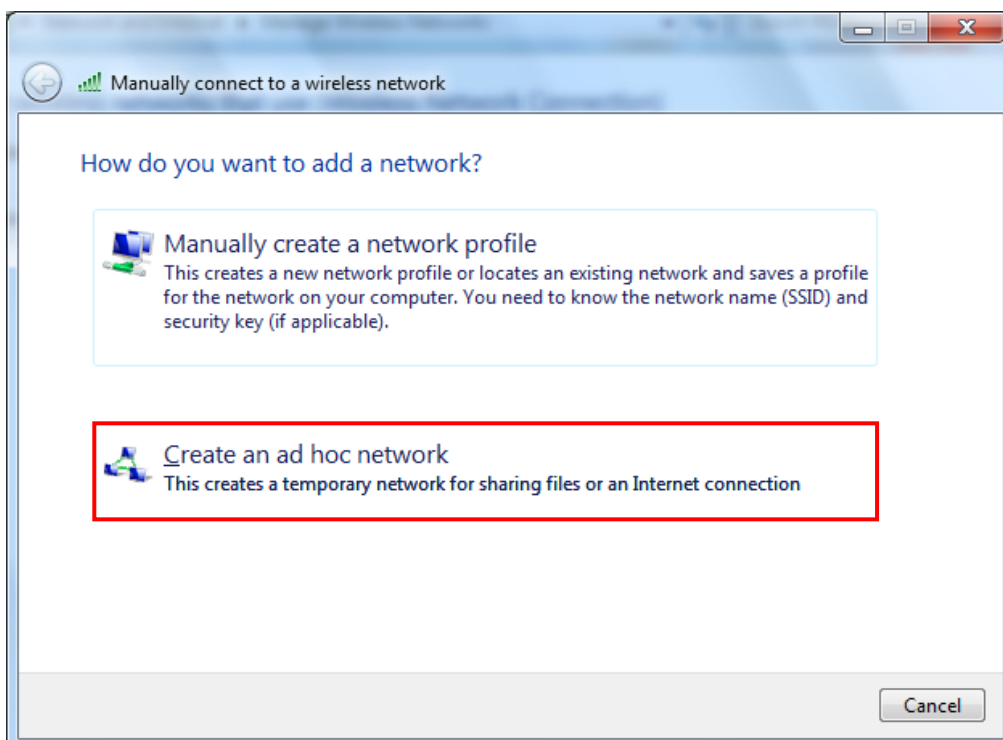

9) Click the “Next”.

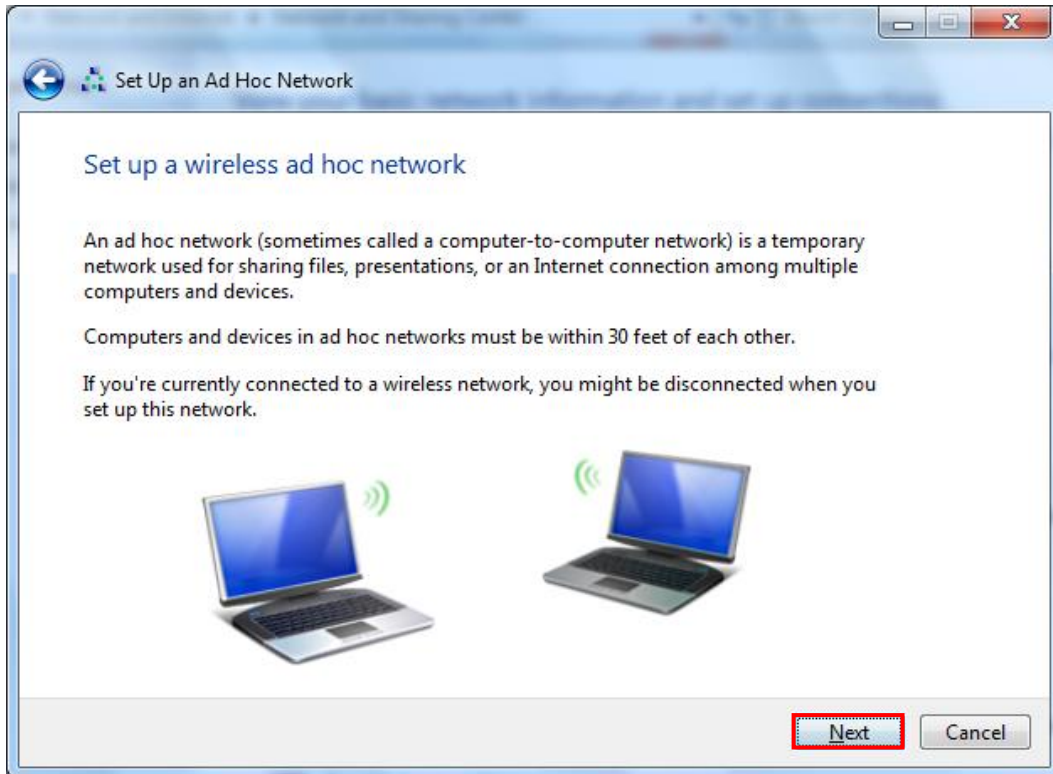

10) 'Network name' = BIXOLON\_adhoc,  
'Security type' = Open,  
'Save this network' check, and then click the “Next”.

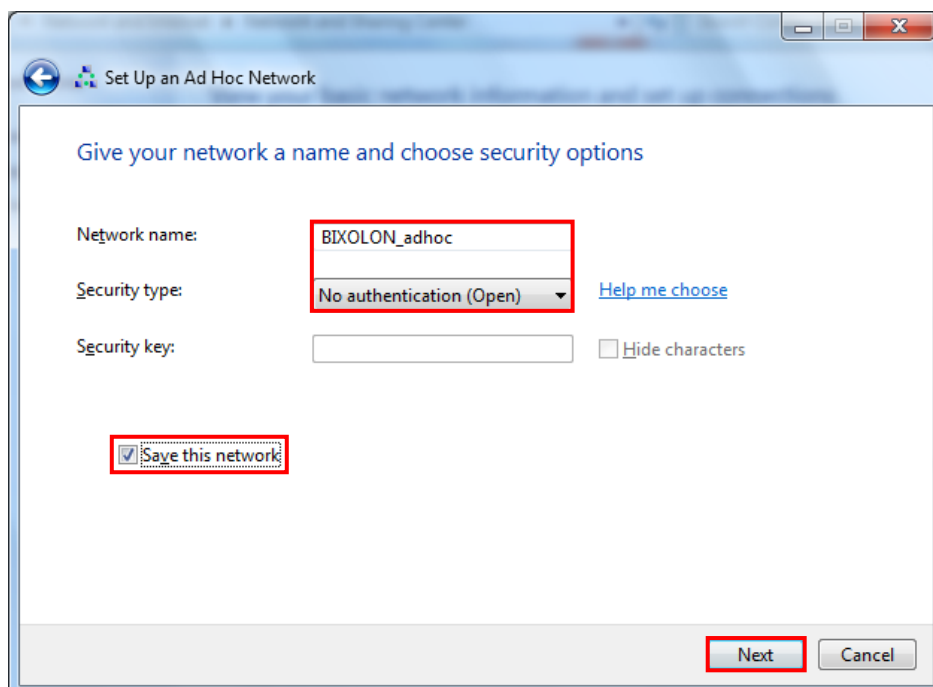

11) Click the “Close”.

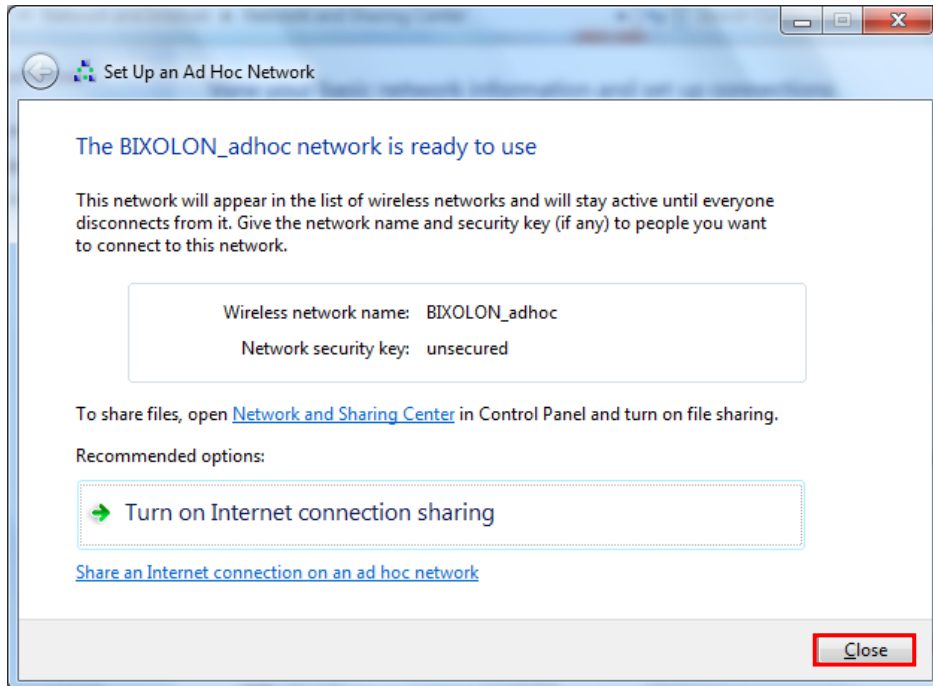

12) After completing configuration, Bixelon\_adhoc network will be created.

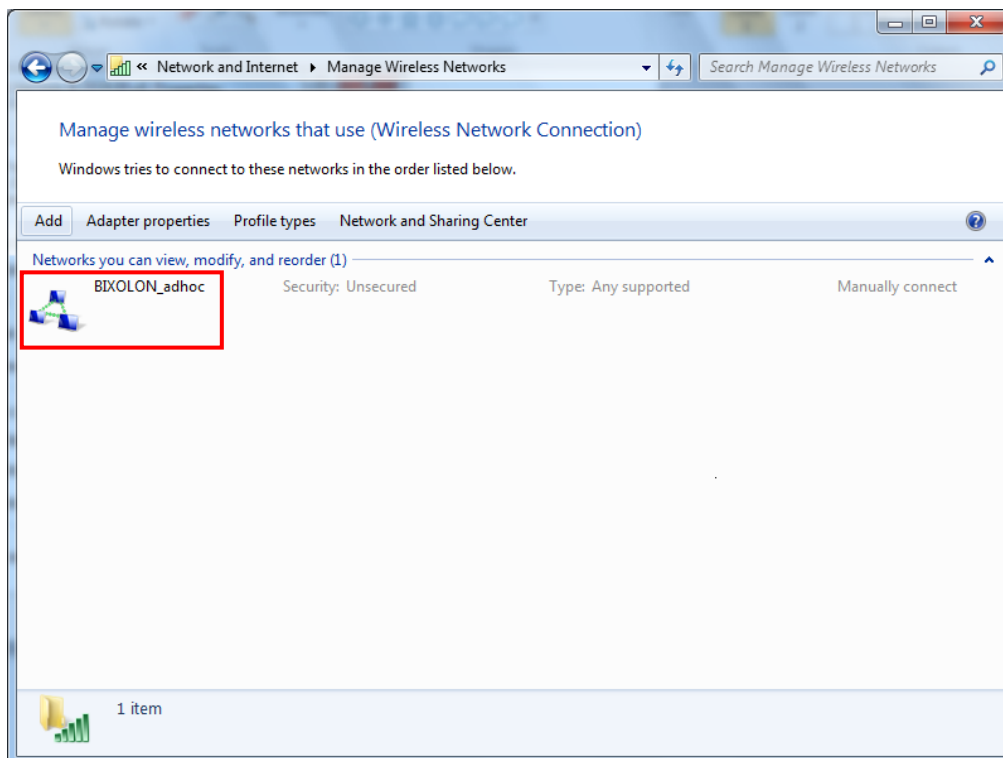

When the printer is set to the default value(Adhoc mode, SSID: BIXOLON\_adhoc), it will automatically connect.

**3. Configuration**

## LAN Setting Values

Classification	Item	Remarks	Input Range
Home		LAN setting status display	
System	Printer Name	Printer name	0~32 letters
	Printer Port	TCP Raw port that the printer can use	0~32767 integers (except 21, 23, 25, 80, 443, 3318)
	User Name	ID to use for ftp, telnet, web-server log-in	1~32 letters
	User Password	Password to use for ftp, telnet, web-server log-in	1~32 letters
	Confirm Password	Confirm Password	1~32 letters
Protocol	WebServer SSL	Set whether to use HTTPS or not Http cannot be used when using Https	Enable/Disable
	TELNET	Set whether to use Telnet	Enable/Disable
	FTP	Set whether to use FTP	Enable/Disable
	SMTP	Set whether to use SMTP	Enable/Disable
Network	Inactivity Time	TCP connection hold time	0~3600 integer(Sec)
	IP Assignment Method	IP assignment method	DHCP/Manual
	IP Address	Printer IP	IP Address
	Subnet Mask	Subnet mask	IP Address
	Gateway	Default Gateway	IP Address
	DNS	Domain name server IP	IP Address



## Network Interface

### WLAN Setting Values

Classification	Item	Remarks	Input Range
Home		WLAN setting status display	
System	Printer Name	Printer Name	0~32 letters
	Printer Port	TCP Raw port that the printer can use	0~32767 integers (except 21,23,25,80,443, 3318)
	User Name	ID to use for ftp, telnet, web-server log-in	1~32 letters
	User Password	Password to use for ftp, telnet, web-server log-in	1~32 letters
	Confirm Password	Confirm Password	1~32 letters
Protocol	WebServer SSL	Set whether to use HTTPS Http cannot be used when using Https	Enable/Disable
	TELNET	Set whether to use Telnet	Enable/Disable
	FTP	Set whether to use FTP	Enable/Disable
	SMTP	Set whether to use SMTP	Enable/Disable
Network	Network Mode	Wireless LAN operating mode	Infrastructure/Adhoc
	Adhoc Channel	Channel when creating Adhoc network	1~14
	SSID	ID of the AP to connect	1~32 letters
	Inactivity Time	TCP connection hold time	0~3600 integer
	IP Assignment Method	IP Assignment Method	DHCP/Manual
	IP Address	Printer IP	IP Address
	Subnet Mask	Subnet mask	IP Address
	Gateway	Default Gateway	IP Address
Authentication	DNS	Domain name server IP	IP Address
	Authentication	Wireless LAN authentication method	open, shared, wpa1/2-psk, wpa1/2
	Cryptograph	Wireless LAN encryption method	none, WEP64/128,TKIP, AES
	EAP Mode	Authentication method	none, PEAP, TLS, LEAP, FAST
	WEP Key	Key for WEP encryption method	WEP64(5 Ascii, 10 Hex) WEP128(13 Ascii, 26 Hex)
	PSK Key	Key for PSK encryption method	1~64 letters
	Authentication ID	ID for EAP Authentication	1~32 letters
Authentication PW	Password for EAP Authentication	1~32 letters	
Wizard		Setting wizard for each step	

## 3-1 Configuration Tool

Install Net Configuration Setup\_[version] and execute it from the CD.  
(Start>>BIXOLON>>Net Configuration)

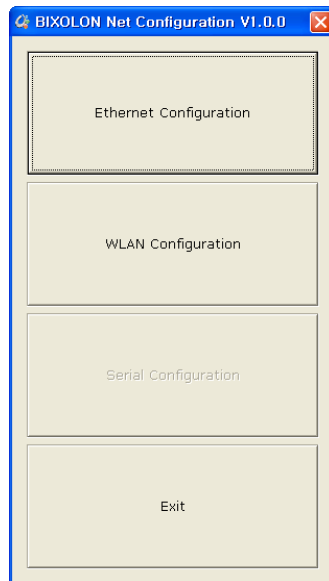

Click the Ethernet Configuration button when the printer is connected to the Ethernet, or click the WLAN button when the printer is connected through WLAN.

### LAN Configuration

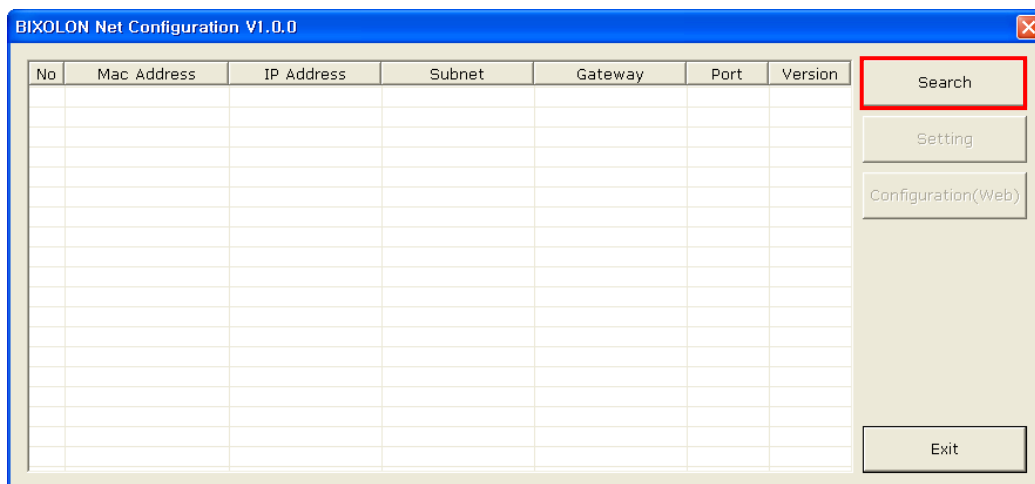

## Network Interface

When you press the Search button, the printer connected to the network will be shown in the list. The following warning message may pop up if the firewall is installed.



Select [Unblock], and then retry the Search operation.

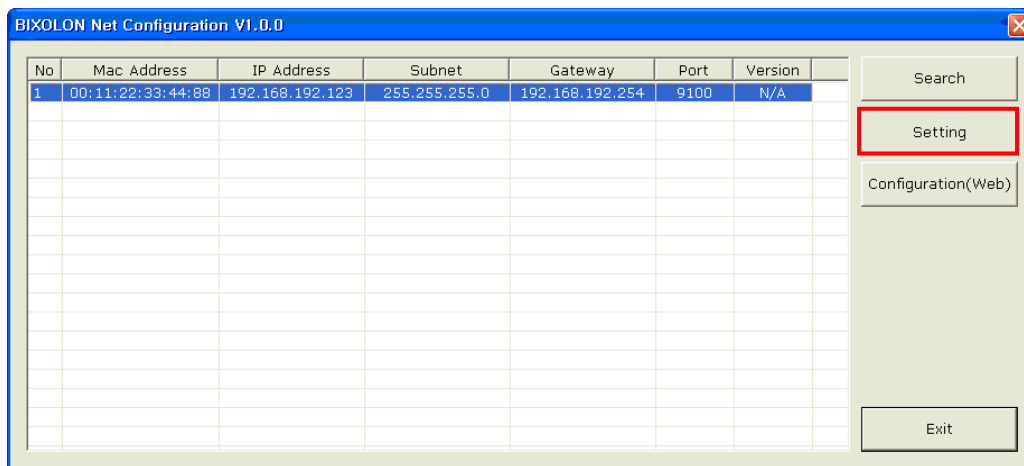

Select the printer from the list and press the [Setting] button, and then the following window for setting Ethernet settings will pop up.

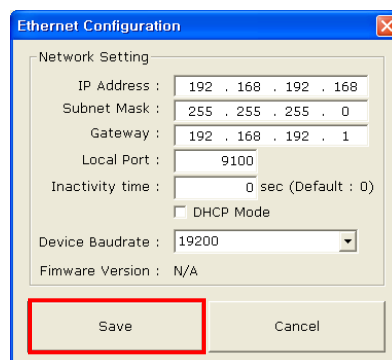



# Network Interface

When you log in, you will see the web browser for changing the Ethernet and WLAN settings as shown below.

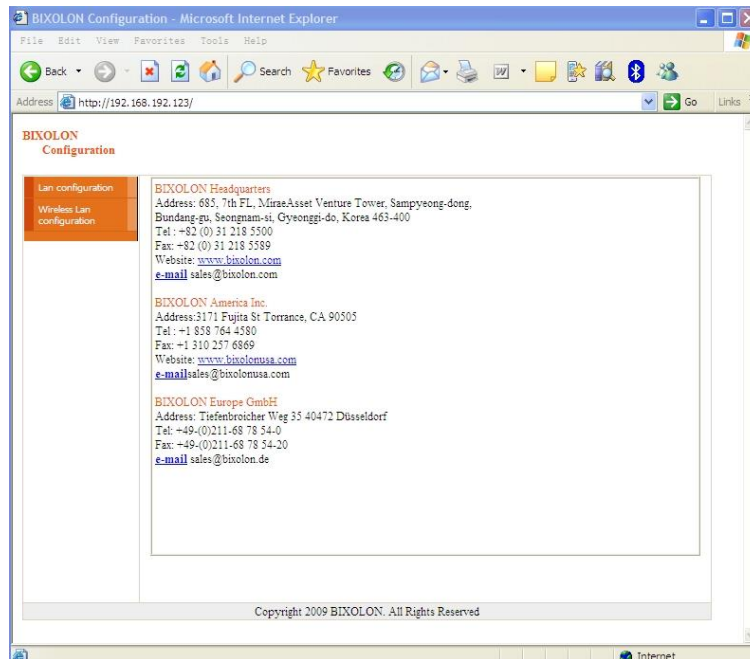

## WLAN Configuration

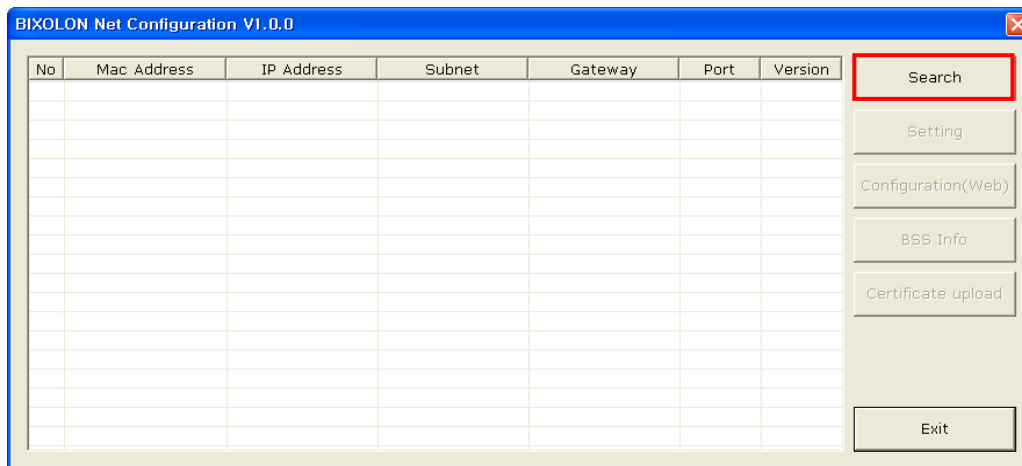

When you press the Search button, the printer connected to the network will be shown in the list.

# Network Interface

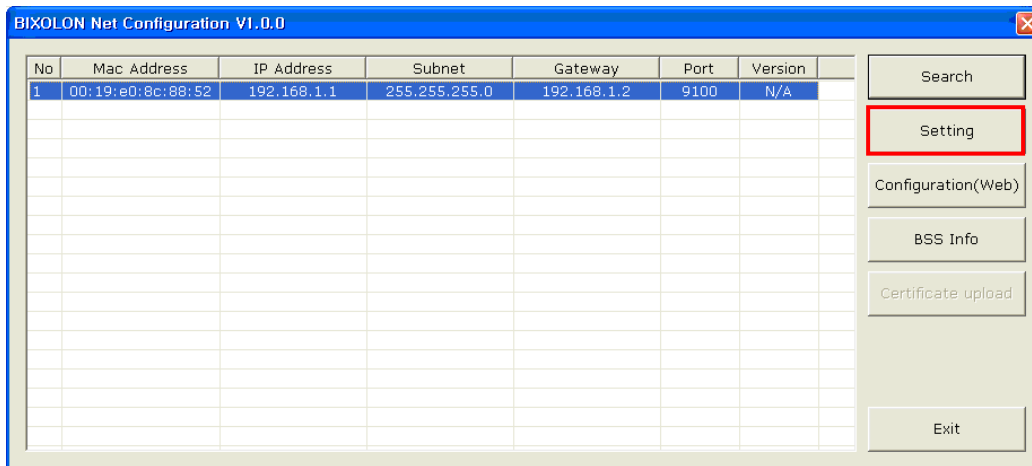

Select the printer from the list and press the [Setting] button, and then the following window for changing the WLAN settings will pop up.

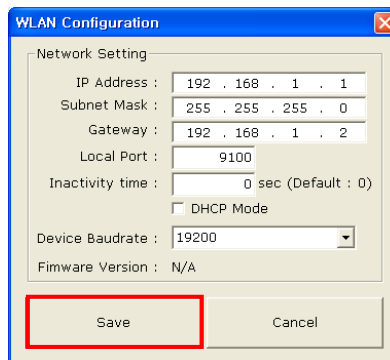

Enter the proper IP Address, Subnet Mask, and Gateway of the currently used network, and then click the [Save] button to save the settings.  
(Device Baudrate setting, which is used for other models, is not necessary for Printer.)

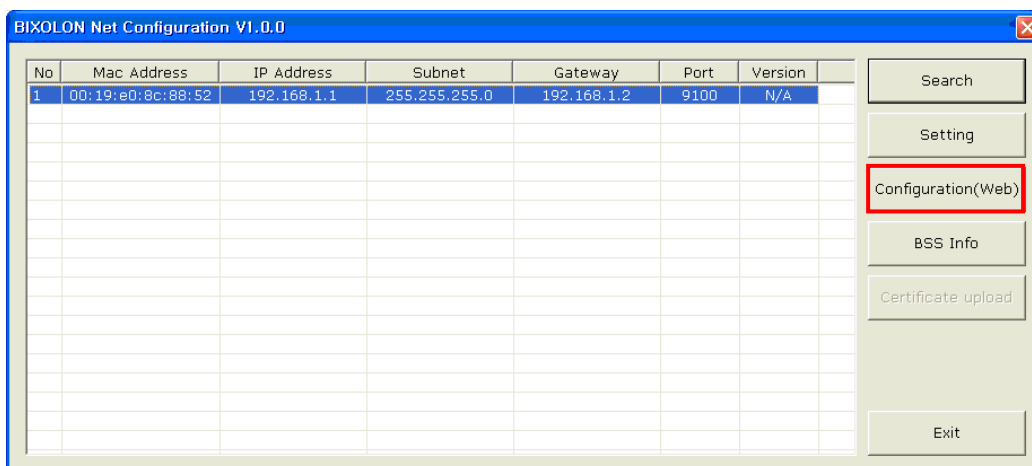

## Network Interface

Select the printer from the list and press the [Configuration(web)] button, and then the Login window will pop up. Enter the ID and Password set in the printer, and click OK.  
(Default settings are ID: “admin”, Password: “password”)



When you log in, you will see the web browser for changing the Ethernet and WLAN settings as shown below.

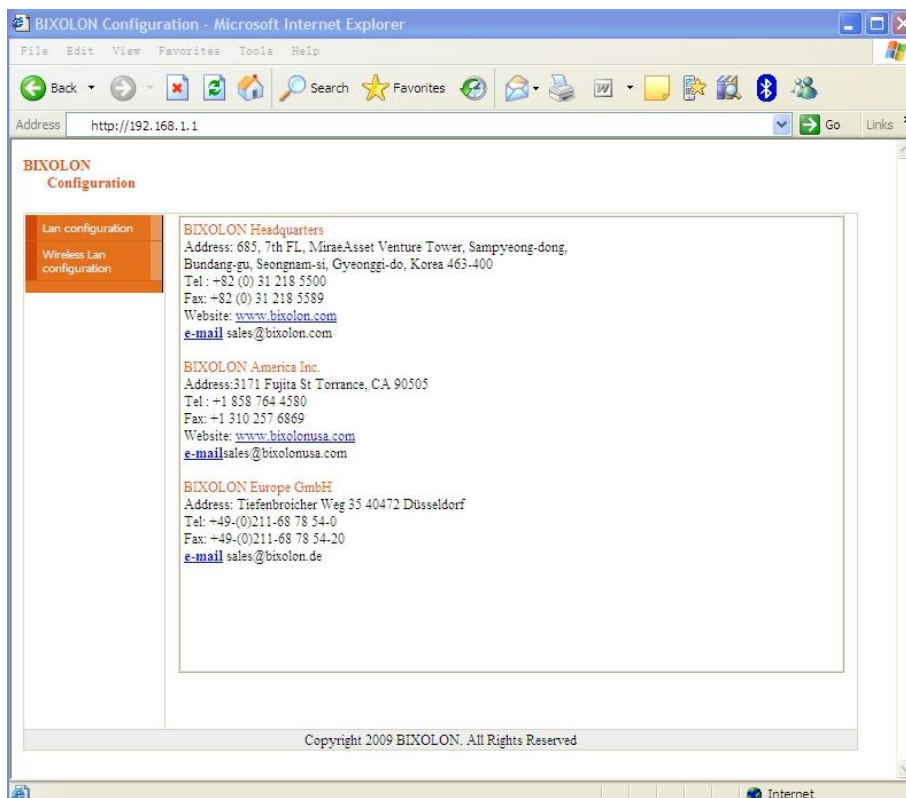





## 3-2 Web Browser

Printer supports the security enhanced https protocol as well as http. When SSL of the web server of Printer is enabled, you must enter the address with “https” instead of “http” in the address bar to connect to the web-server.

(Automatic connection will be made when connecting with the configuration tool.)

When SSL of the web-server is enabled,

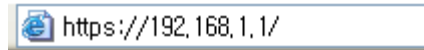

\* A security warning window will pop when you try to connect with https.

Accept the certificate provided by the printer in the warning window and continue.

When SSL of the web-server is disabled,

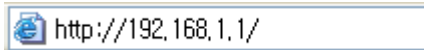

Enter the IP address of the printer in the address bar, and the following login window will pop up. Enter the ID and Password set for the printer, and then click [OK]

(Default setting values are ID: “admin”, Password: “password”.)



# Network Interface

When the ID and Password match the ones registered in the printer, the following window will be opened.

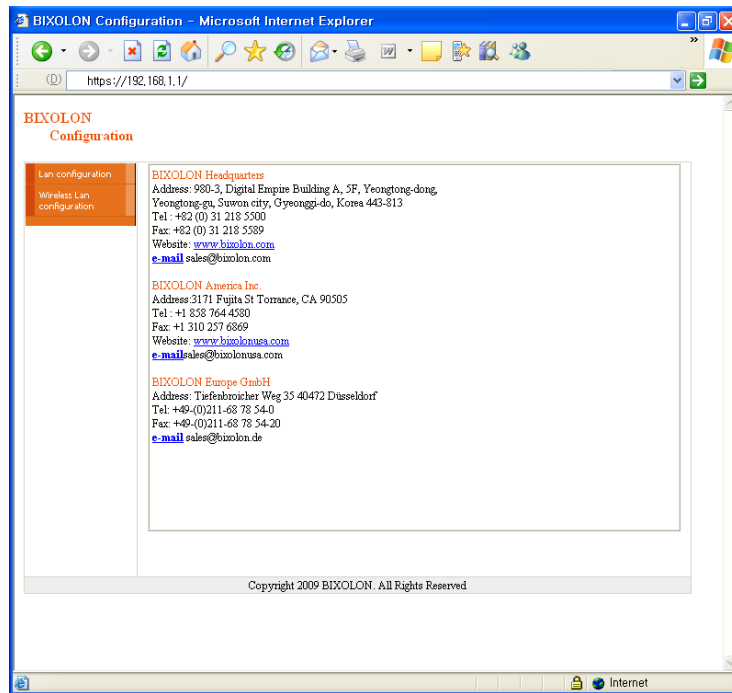

Both LAN and WLAN can be configured from this window.

## LAN Configuration Selection

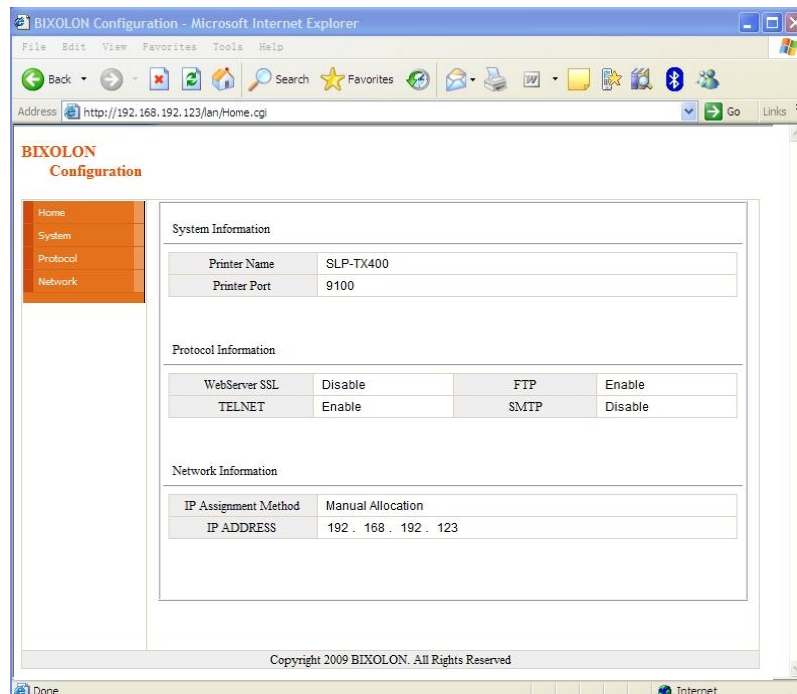

Settings related to Home, System, Protocol, and Network(LAN) can be configured in this window.

## Wireless LAN selection

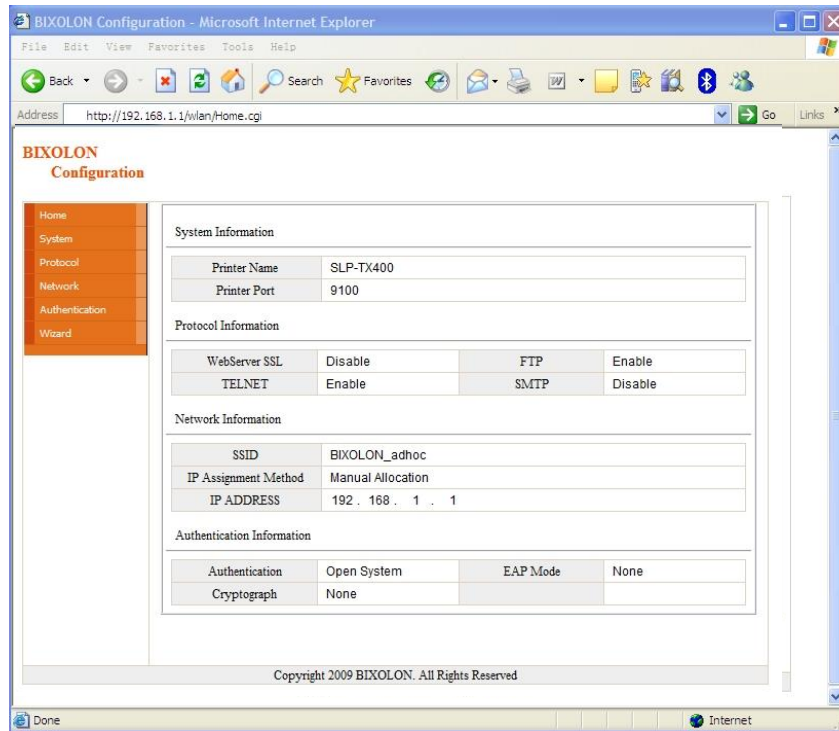

Home, System, Protocol, Network(WLAN), and Authentication can be configured from this window, and the wizard mode is also provided for easier step by step configuration.

### 3-3 FTP

The configuration files will be downloaded and uploaded to and from the current path. In the following case, the current path is “C:\Documents and Settings”.

Enter “ftp Printer IP”, and enter the ID and Password set for the printer.

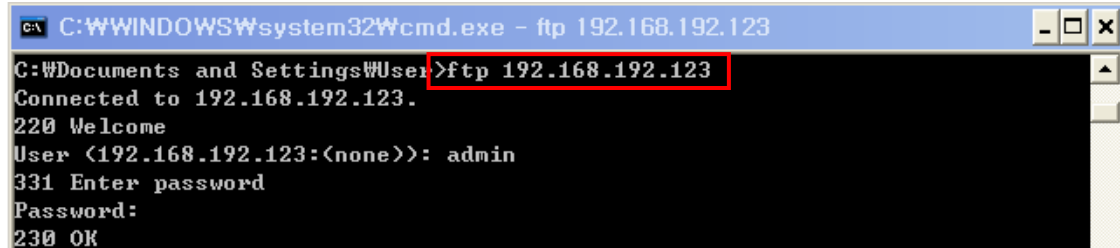

```
C:\WINDOWS\system32\cmd.exe - ftp 192.168.192.123
C:\Documents and Settings\User>ftp 192.168.192.123
Connected to 192.168.192.123.
220 Welcome
User (192.168.192.123:(none)): admin
331 Enter password
Password:
230 OK
```

Enter the “ls” command to check the file name to download.

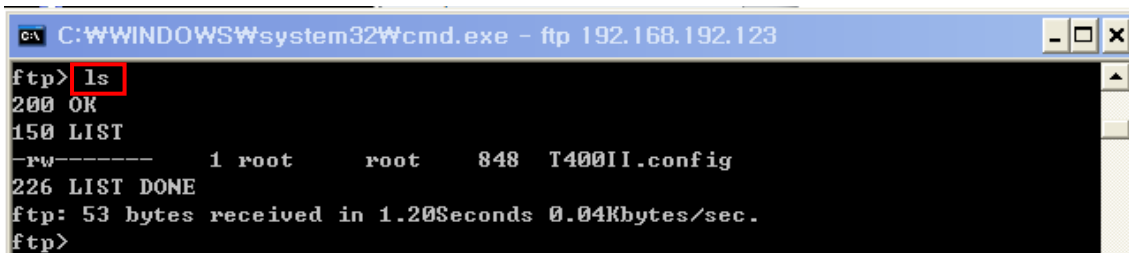

```
ftp> ls
200 OK
150 LIST
-rw----- 1 root root 848 T400II.config
226 LIST DONE
ftp: 53 bytes received in 1.20Seconds 0.04Kbytes/sec.
ftp>
```

Enter “get TX400.config” to download the configuration file.

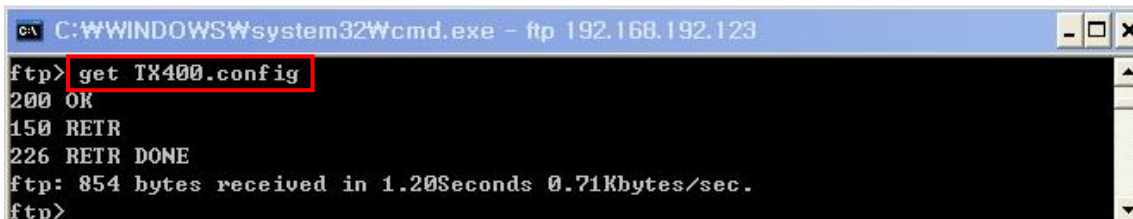

```
ftp> get TX400.config
200 OK
150 RETR
226 RETR DONE
ftp: 854 bytes received in 1.20Seconds 0.71Kbytes/sec.
ftp>
```

You can see that the “TX400.config” file is created in the corresponding directory.

Enter “put TX400.config” command if you want to upload the configuration file in the corresponding directory for the printer.

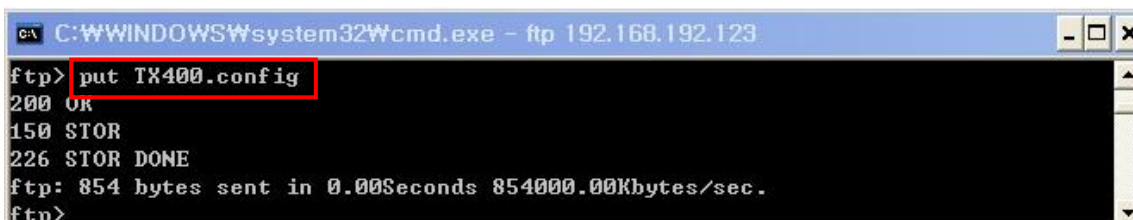

```
ftp> put TX400.config
200 OK
150 STOR
226 STOR DONE
ftp: 854 bytes sent in 0.00Seconds 854000.00Kbytes/sec.
ftp>
```

## Network Interface

The contents of the TX400.config file are as follows.

A screenshot of a Notepad window titled "TX400 - Notepad". The window contains the following configuration text:

```
System
  Printer Name : SLP-TX400
  User ID : admin
  Password : password
  Port : 9100
Protocol
  FTP Enable : 1
  Telnet Enable : 1
  HTTPS Enable : 0
  SMTP Enable : 0
  SMTP Port : 25
  SMTP User :
  SMTP Password :
  SMTP Server :
  SMTP From :
  SMTP To :
  SMTP Interval(Sec) : 3
DNS
  DNS : 168.126.63.1
Inactivity time
  InactivityTime : 0
Ethernet
  LAN DHCP Mode : 0
  LAN IP Address : 192.168.192.123
  LAN Subnet Mask : 255.255.255.0
  LAN Gateway : 192.168.192.254
WLAN
  WLAN Mode : infra
  WLAN Adhoc Channel : 6
  WLAN Authentication : open
  WLAN Cryptograph : none
  WLAN EAP Mode : none
  WLAN EAP ID :
  WLAN EAP Password :
  WLAN ESSID : BIXOLON_adhoc
  WLAN WEP Key : 12345
  WLAN PSK Key : mobile123
  WLAN DHCP Mode : 0
  WLAN IP Address : 192.168.1.1
  WLAN Subnet Mask : 255.255.255.0
  WLAN Gateway : 192.168.0.1
```

\* The format of the configuration file is "Configuration item: Setting value".  
Uploading a file that doesn't have the format shown above will not change the setting values.

## 3-4 Telnet

Enter "telnet Printer IP".

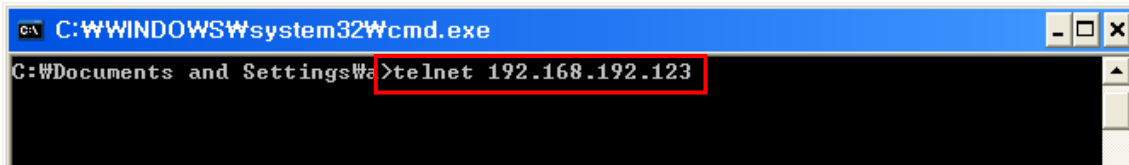

```
C:\WINDOWS\system32\cmd.exe
C:\Documents and Settings\Wa>telnet 192.168.192.123
```

Enter the ID and Password set for the printer.

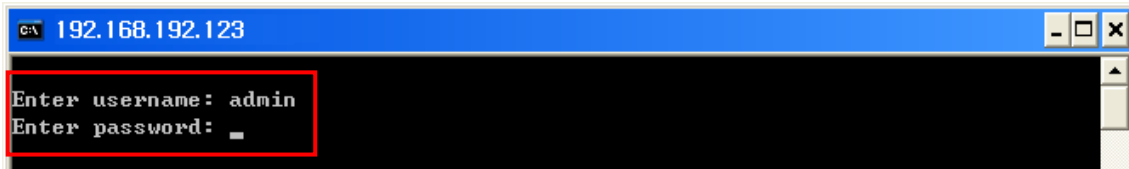

```
C:\ 192.168.192.123
Enter username: admin
Enter password: _
```

The screen related to the network configuration will then be displayed. You can select the menu to configure and edit the settings.

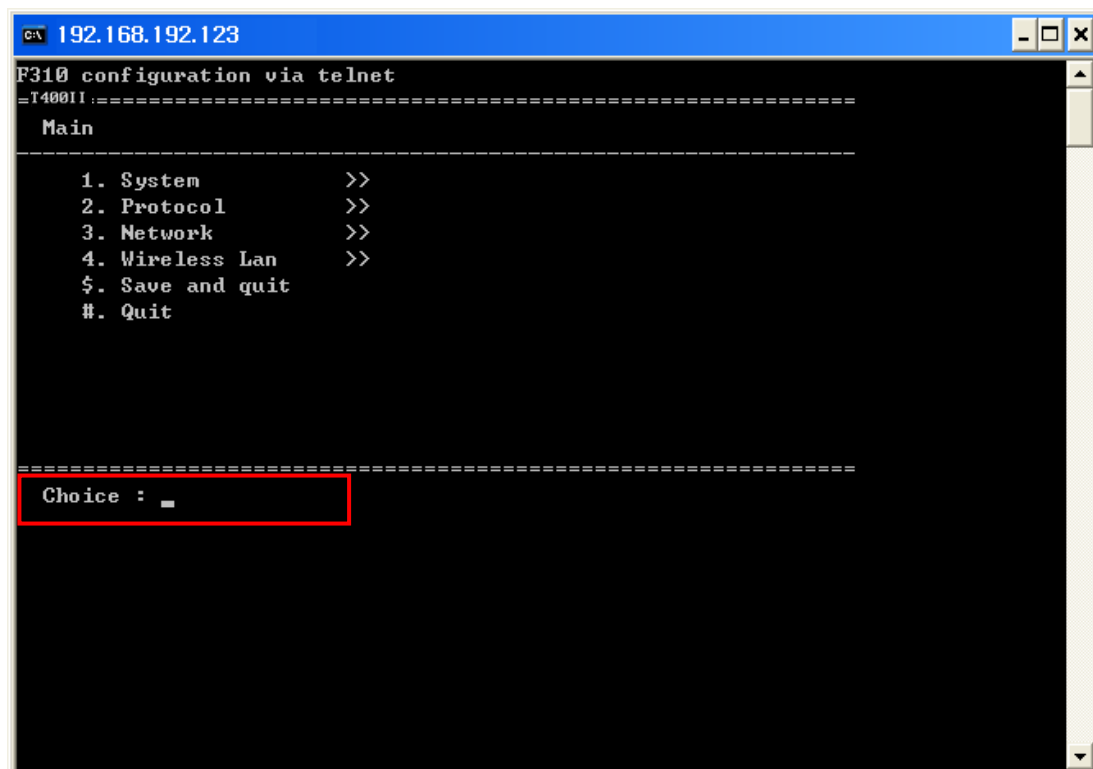

```
C:\ 192.168.192.123
F310 configuration via telnet
=T40011:=====
Main
-----
1. System          >>
2. Protocol        >>
3. Network         >>
4. Wireless Lan    >>
$. Save and quit
#. Quit

=====
Choice : _
```

## 4. SMTP

The changes of the status of the printer are monitored, and a notification e-mail is sent to the registered administrators.

SMTP must be enabled to use the SMTP function.

You can use the web browser, telnet, or ftp to enable the SMTP.

(Refer to Configuration)

Using Web Browser

Connect to the printer web-server.(Enter the IP address of the printer in the address bar.)

Select LAN or WLAN configuration, and then select the Protocol tab.

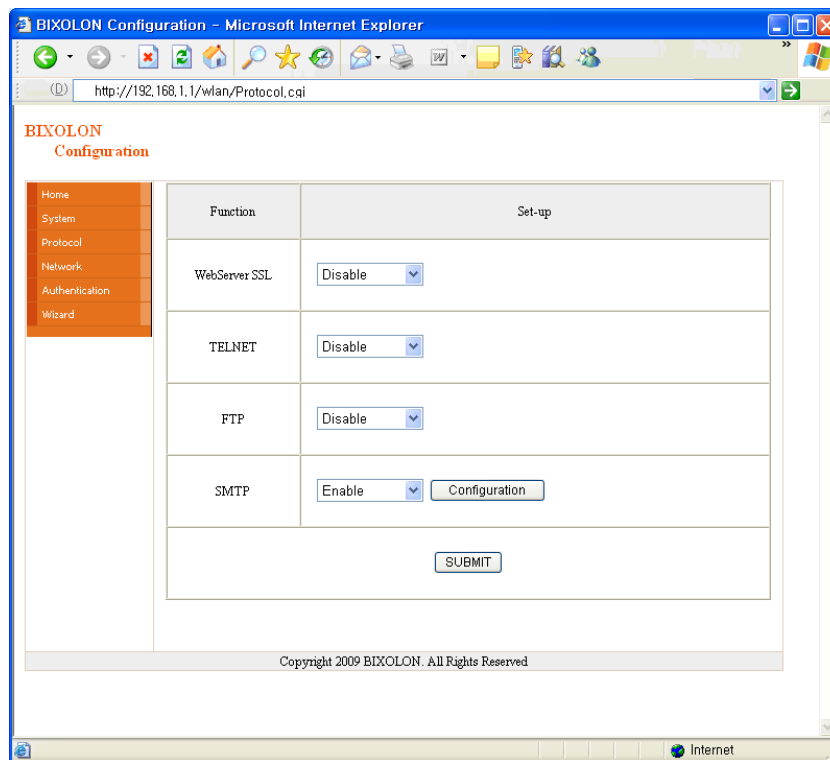

## Network Interface

Click the Configuration button to display the following window.

SMTP	Set-up
SMTP User ID	<input type="text" value="userid@mail_server"/>
SMTP Password	<input type="password" value="....."/>
SMTP Server Name	<input type="text" value="mail_server"/>
SMTP Port Number	<input type="text" value="25"/>
From Address	<input type="text" value="userid@mail_server"/>
To Address	<input type="text" value="dministor@mail_server"/>
Check Interval(Sec)	<input type="text" value="3"/>
Paper Empty	<input type="button" value="OFF"/> ▾
Cover Open	<input type="button" value="OFF"/> ▾
Cutter Error	<input type="button" value="OFF"/> ▾
Ribbon	<input type="button" value="OFF"/> ▾
Calibration Error	<input type="button" value="OFF"/> ▾
TPH Over Heat	<input type="button" value="OFF"/> ▾
Paper Jam	<input type="button" value="OFF"/> ▾

Copyright 2009 BIXOLON. All Rights Reserved



## Network Interface

Check the SMTP setting values

SMTP User ID	Check the ID registered to the mail server
SMTP Password	Enter the password for the corresponding User ID
SMTP Server Name	Enter the mail server(Example: Domain or mail server IP) * Check DNS settings when entering domain
SMTP Port Number	Enter SMTP port Default value of the SMTP Port is 25
From Address	Enter the e-mail address to be shown at the mail receiver
To Address	Enter the e-mail address to receive
Check Interval	Enter the period to check the printer status Entered value will be effective in second unit
Paper Empty	ON – E-mail is sent out when there is no paper OFF – Paper empty status is not checked
Cover Open	ON – E-mail is sent out when the printer cover is open OFF – Printer cover status is not checked
Cutter Error	ON – E-mail is sent out when there is error in the auto cutter OFF – Auto cutter error is not checked
Near End	ON – E-mail is sent out when the printer is almost out of paper OFF – Paper remaining status is not checked
Ribbon	ON – E-mail is sent out when there is no ribbon OFF – Paper empty status is not checked
Calibration Error	ON – E-mail is sent out when calibration is failed OFF – Doesn't check auto paper setting errors
TPH Over Heat	ON – Check TPH when overheated OFF – Doesn't check TPH overheat
Paper Jam	ON – E-mail is sent out when paper is jammed OFF – Doesn't check paper jam

### 5. Ethernet / WLAN Test by using Windows Test Page

You can use the Windows printer driver as shown below when there is no test program. Operating systems that allow you to use the Windows printer driver are Windows 2000, XP, 2003 Server, VISTA, 2008 Server, 7, 8, 10.

1) Install the Windows printer driver.

**[Note]**

- The Windows driver is included in the CD, and you can download the latest version from our home page.

([www.bixelon.com](http://www.bixelon.com))

2) Click the “Start” button, and then select “Printers and Faxes.”

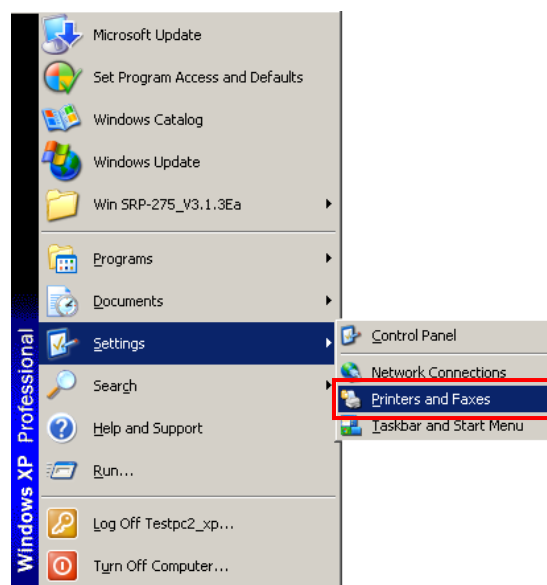

3) Select and right click on the corresponding model, and then select “Properties.”

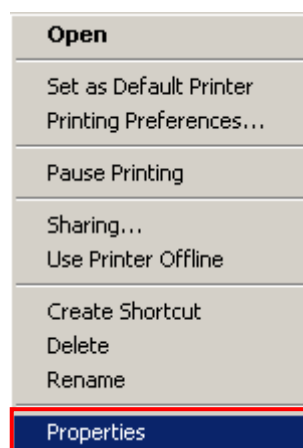

4) Select the “Ports” tab from the “Properties” window.

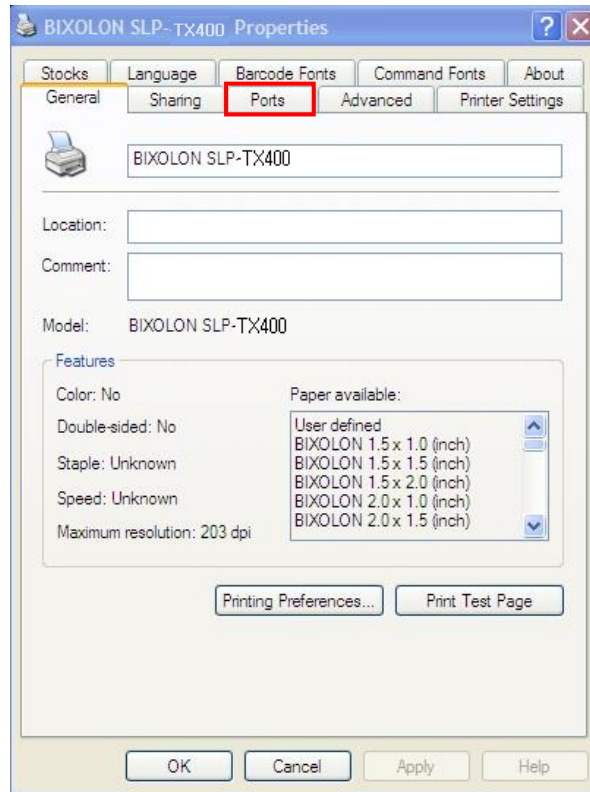

5) Click “Add Port...”

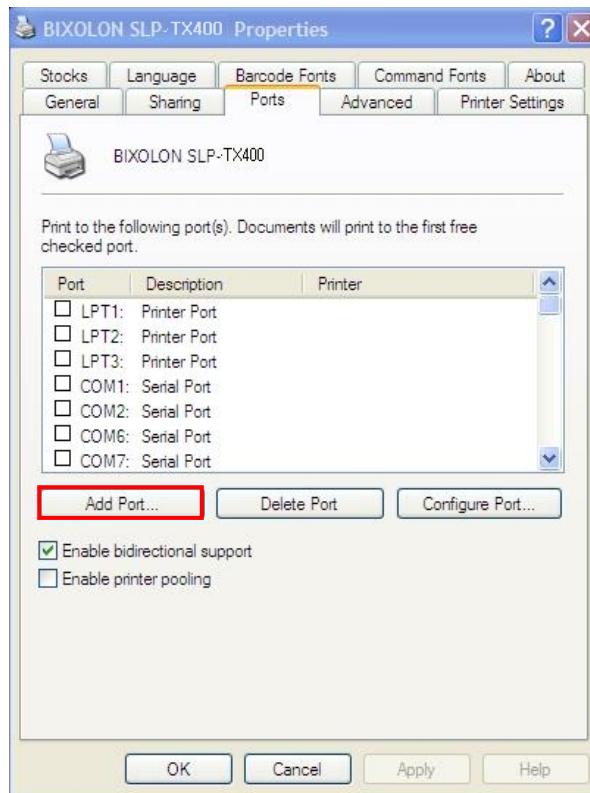

## Network Interface

6) Select “Standard TCP/IP Port” and click “New Port...”

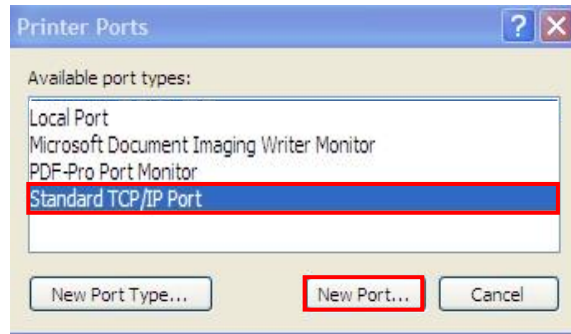

7) Click the [Next] button in the “Add Standard TCP/IP Printer Port Wizard” window.

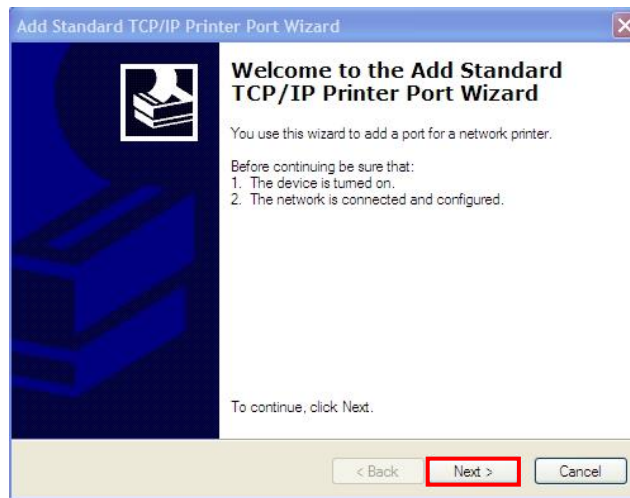

8) Enter the IP address assigned to the printer in the “Printer Name or IP Address” field in the “Add Port” pop up window, and then click the [Next] button.

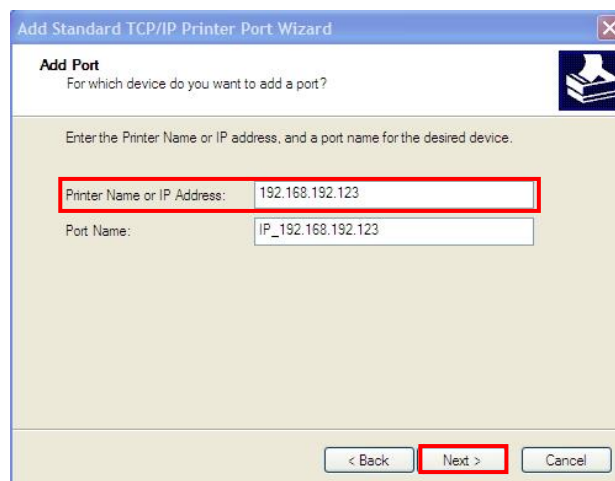

### **[Note]**

- Enter the same IP address entered during the installation of the interface card. Only enter the “Printer name or IP address.”

## Network Interface

9) Click the [Next] button in the “Additional Port Information Required” window.

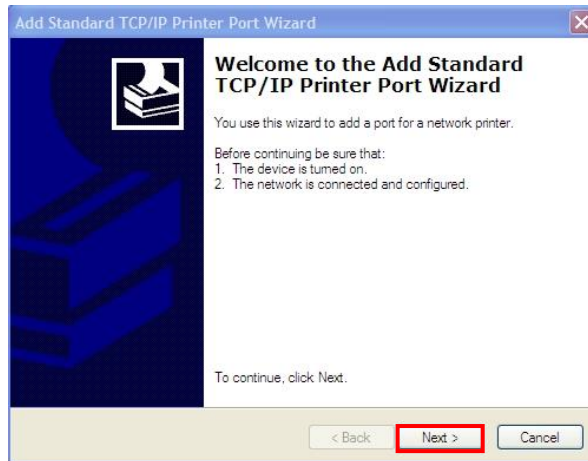

### **[Note]**

- Click the [Next] button to proceed without any changes.

10) Click the [Finish] button at the “Completing the Add Standard TCP/IP Printer Port Wizard” window.

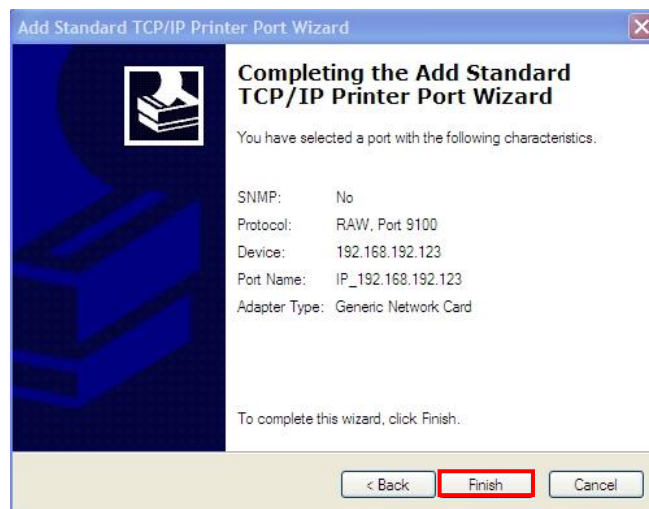

11) Click the “Cancel” button in the Printer Port window, closing the window.

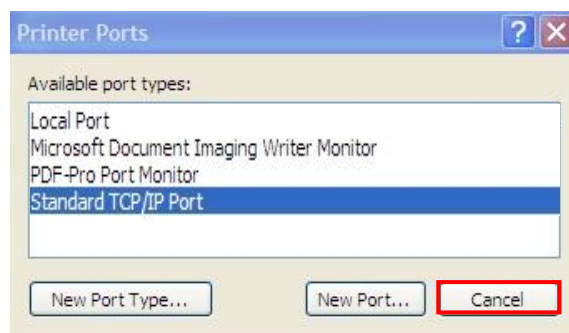

## Network Interface

12) Click the “Configure Port...” button in the “Properties” window.

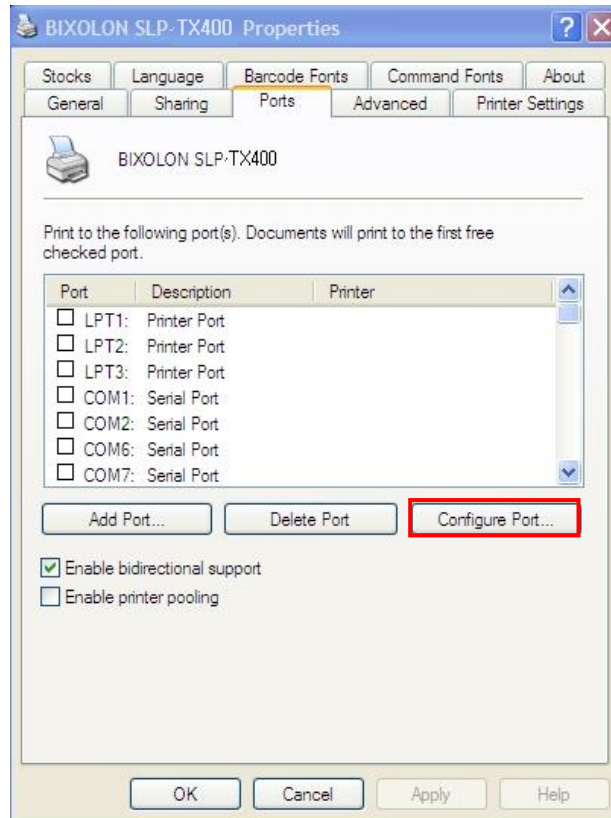

13) Enter the same number as the local port number set during the installation of the interface card in the “Port Number” field in the Raw Settings.

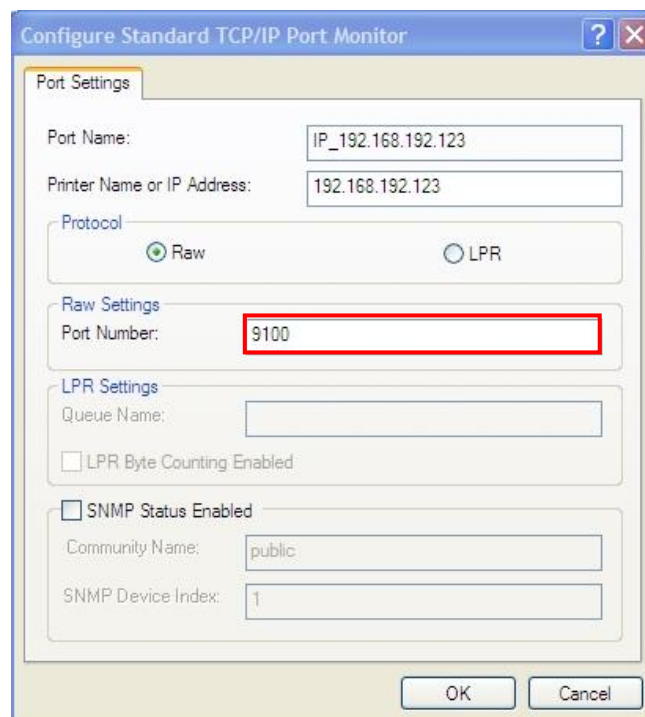

### **[Note]**

- Do not change any other items except the RAW Settings.

## Network Interface

- 14) Click [OK] when you finish entering the required values, and then click the [Apply] button.

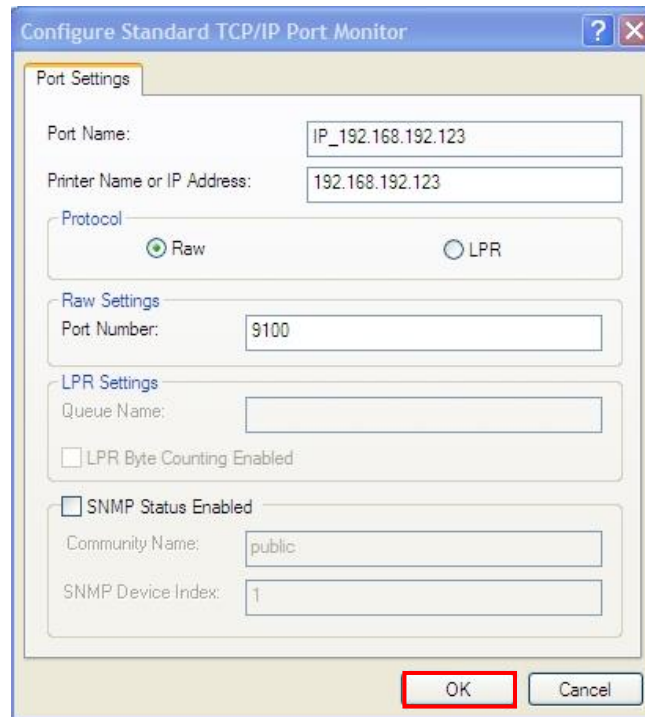

- 15) Select the "General" tab in the Properties window, and then select the "Print Test Page" to check the printing status.

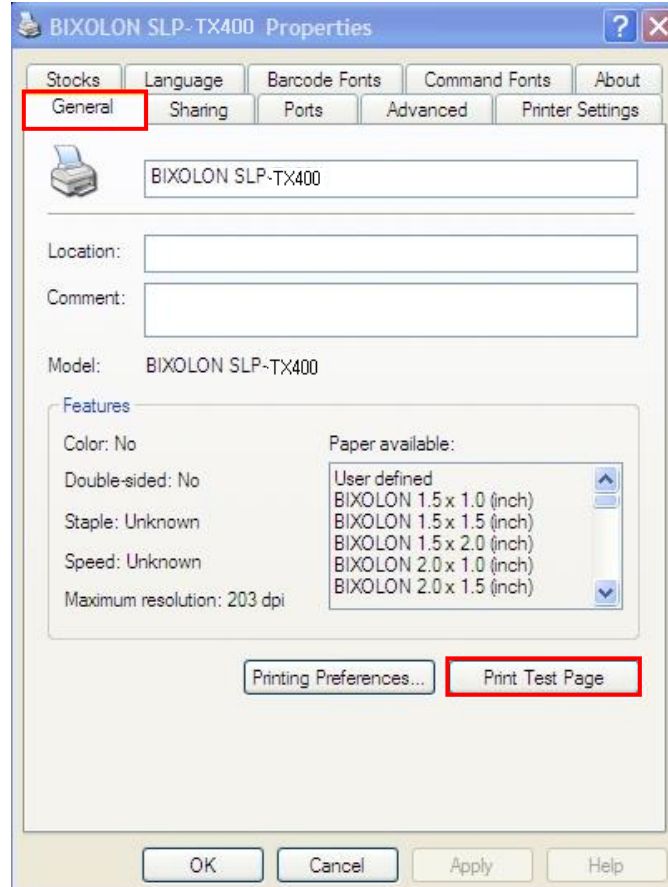

### 6. Factory Reset

This function changes the Ethernet and WLAN settings of the printer to the initial factory settings.

- SSID of WLAN will be reset as Default(BIXOLON\_adhoc)

#### **Method(There are 2ways to make the printer WLAN reset)**

1) In order to carry out the factory reset, turn off the printer, and then turn on the printer while pressing the reset button as shown in the following picture.  
(Please wait for about 10 to 15 seconds while holding down the reset button)

2) Send the network factory.bin file to the printer via Unified Label Utility.

\* Network Self Test

- Push the below reset button to check the Ethernet, WLAN information.

[TX40x]

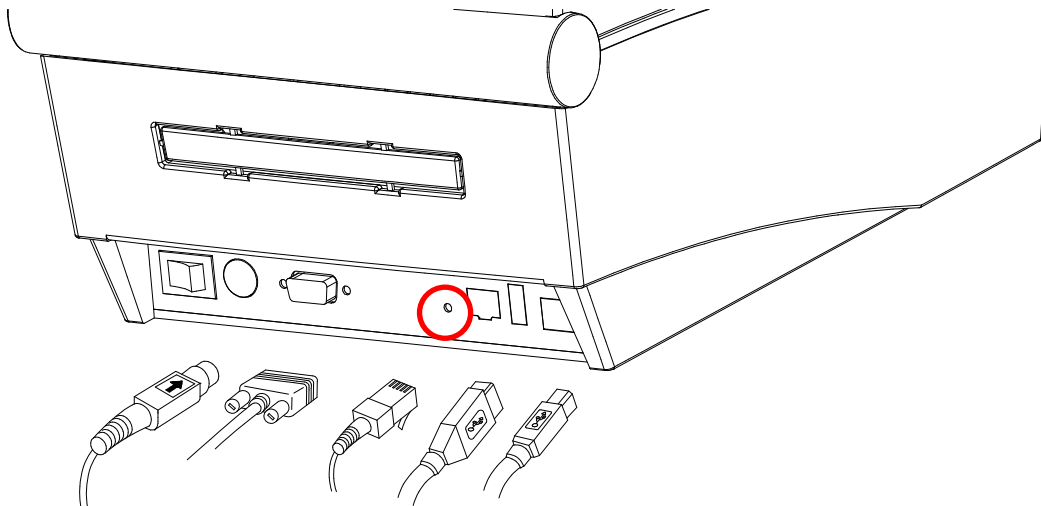

[TX42x/DX42x]

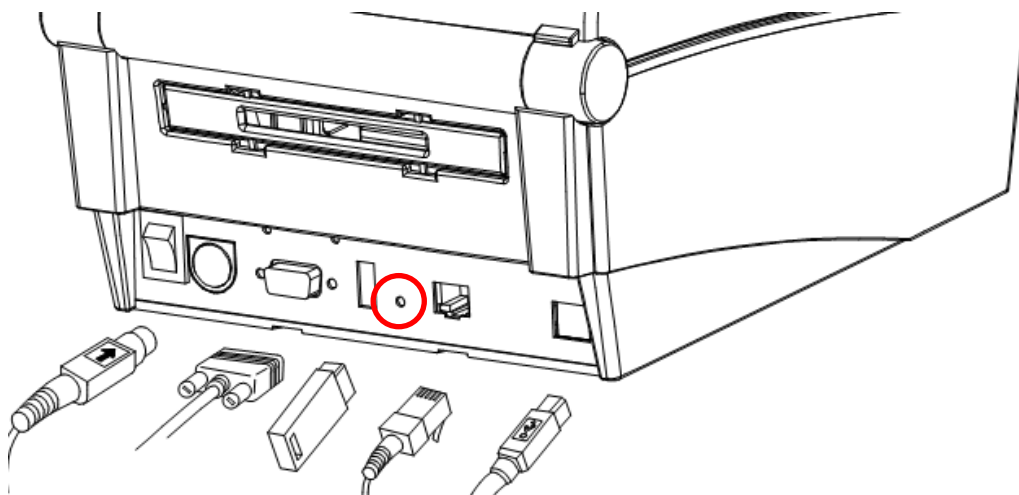



# Network Interface

[DX22x/TX22x]

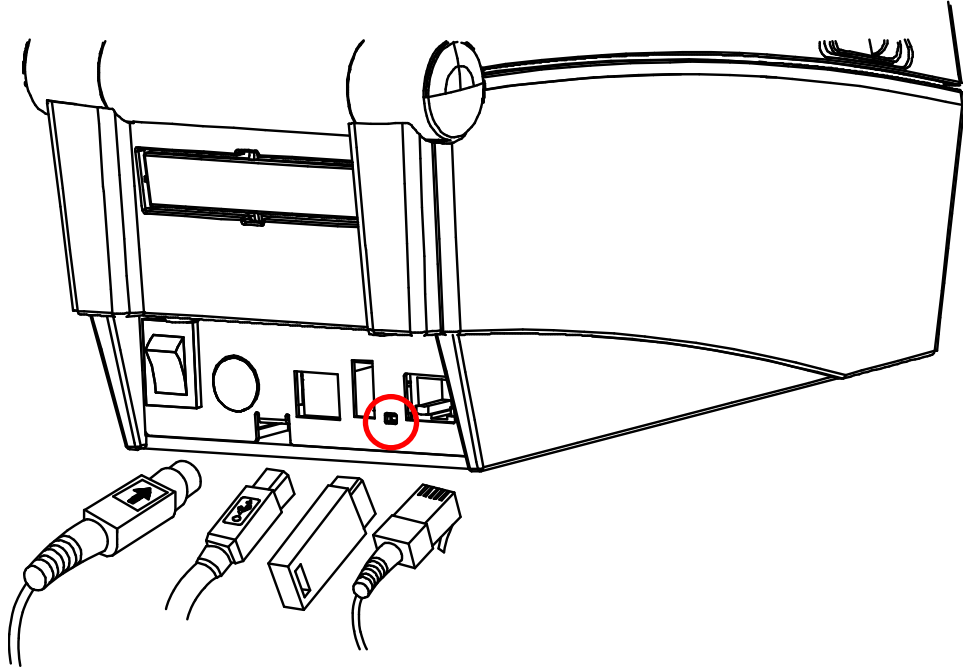

[DL41x]

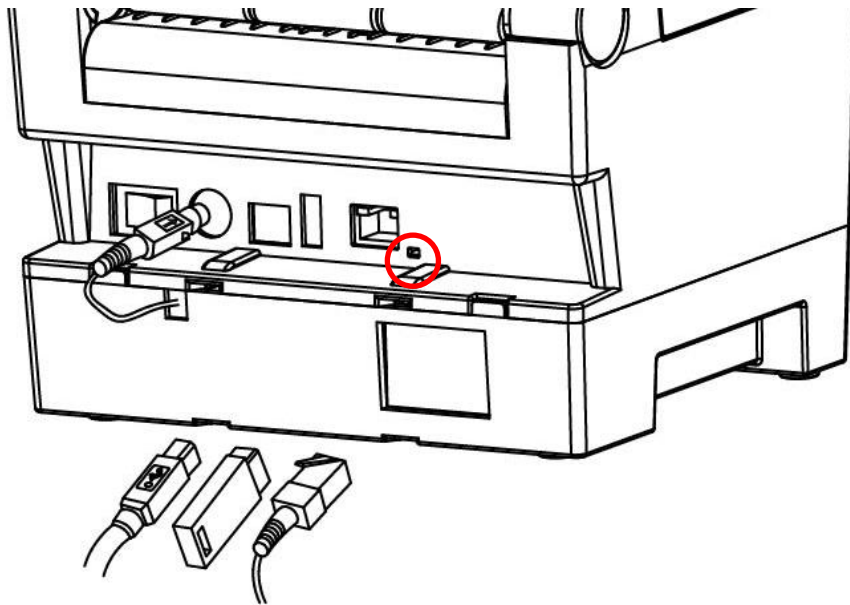

## Network Interface

### Factory Reset Values

Printer Name	Printer Name	SLP-TX400/TX403 SLP-TX420/TX423 SLP-TX220/TX223 SLP-DX420/DX423 SLP-DX220/DX223 SLP-DL410/DL413	
	Printer Port Number	9100	
	User ID	admin	
	User Password	password	
Protocol	FTP	Disabled	
	TELNET	Disabled	
	HTTPS	Disabled	
	SMTP		Disabled
			SMTP Server Name: ""
			SMTP Port Number: 25
			From Address: ""
			To Address: ""
			Check Interval(Sec): 10
			Paper Empty: OFF
	Cover Open: OFF		
	Cutter Error: OFF		
	Near End: OFF		
Authentication	Open System	None	
	Shared key	None	
LAN	IP Assignment Method	DHCP	
WLAN	Network Mode	Ad-hoc, channel 6	
	SSID	BIXOLON_adhoc	
	IP Assignment Method	manual	
	IP, Subnet, Gateway	IP: 192.168.1.1 Subnet: 255.255.255.0 Gateway: 192.168.1.2	

### 7. Troubleshooting

When printing doesn't work

Check network setting

When using Ethernet

- IP Address  
Check whether the IP Address band of the printer and the AP(or wireless terminals) are the same. The first three digits of the four digit value in the IP Address must be the same.
- Subnet Mask  
Check whether the subnet mask of the printer matches with the one in AP(or wireless terminal).
- Port  
Check whether the port configured in the printer and the host(PC, PDA) are the same.

When using WLAN

Check the wireless network setting of the AP and the printer.

(Refer to Configuration for checking/changing the printer settings)

- SSID  
Check whether the SSID of the printer matches with the one in AP(or wireless terminal)
- 802.11 mode  
Check whether AP supports 802.11b or 802.11g.  
BIXOLON printer supports 802.11b/g, and 802.11a is not supported.
- Network Mode  
Check the network mode of the printer.  
Network mode must be set to "Infrastructure" to connect to AP and "Ad-hoc" to connect between wireless terminals.
- IP Address  
Check the band of the IP Address.  
Check whether the band of the printer and the AP(or wireless terminals) are the same.  
The first three digits of the four digit value of the IP address must be the same.
- Subnet Mask  
Check whether the subnet mask of the printer matches the one in AP(or wireless terminal).

## Network Interface

- Port  
Check whether the port configured in the printer and the host(PC, PDA) are the same.
- Authentication/Encryption  
Check the authentication/encryption setting status.  
Check whether the settings of the printer and the AP(wireless terminals) are the same.

### PING Check

#### Checking IP collision

- When entering IP address manually without using DHCP, you must check whether the corresponding IP address is used by other equipment. The printer may not work normally when there is a collision in the IP address.
- When the printer is turned off, carry out the Ping Test to the printer IP.

### Ping TEST

- Turn off the printer.
- Select "Run" from the Windows Start menu, and then enter "cmd".
- Enter "ARP -d" and delete ARP table.
- Enter "ping {printer IP}".
- ARP -d, ping {IP address}

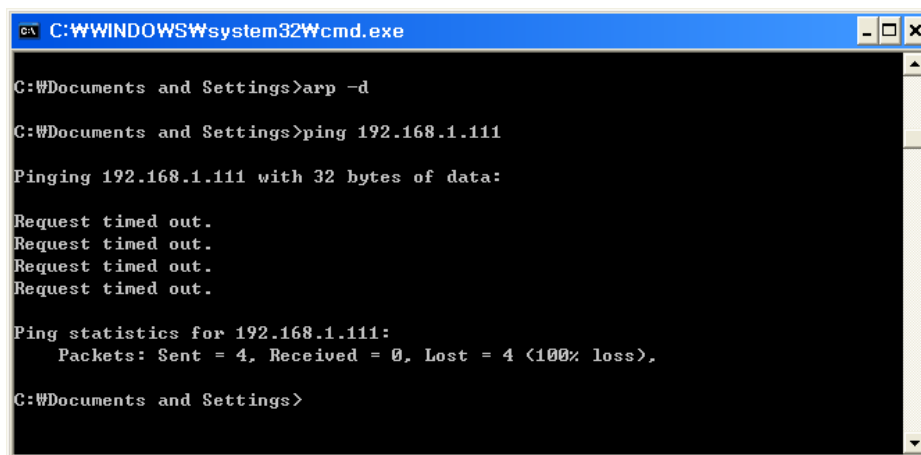

```
C:\WINDOWS\system32\cmd.exe
C:\Documents and Settings>arp -d
C:\Documents and Settings>ping 192.168.1.111
Pinging 192.168.1.111 with 32 bytes of data:
Request timed out.
Request timed out.
Request timed out.
Request timed out.
Ping statistics for 192.168.1.111:
    Packets: Sent = 4, Received = 0, Lost = 4 (100% loss),
C:\Documents and Settings>
```

When you see "Request timed out." as shown below, it means that there is no collision. The corresponding IP can be used.

## Network Interface

On the other hand, if there is a reply as shown below, then the corresponding IP is used by another network terminal and it cannot be used for the printer IP.

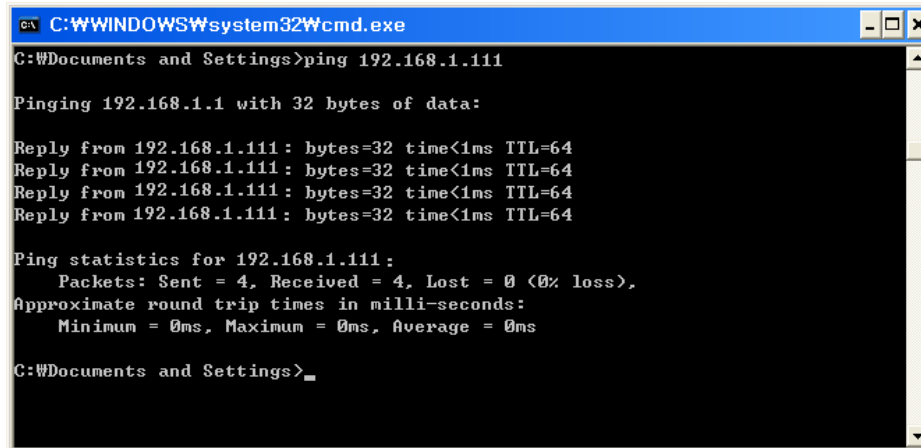

```
C:\WINDOWS\system32\cmd.exe
C:\Documents and Settings>ping 192.168.1.111

Pinging 192.168.1.1 with 32 bytes of data:

Reply from 192.168.1.111: bytes=32 time<1ms TTL=64
Reply from 192.168.1.111: bytes=32 time<1ms TTL=64
Reply from 192.168.1.111: bytes=32 time<1ms TTL=64
Reply from 192.168.1.111: bytes=32 time<1ms TTL=64

Ping statistics for 192.168.1.111:
    Packets: Sent = 4, Received = 4, Lost = 0 (0% loss),
    Approximate round trip times in milli-seconds:
        Minimum = 0ms, Maximum = 0ms, Average = 0ms

C:\Documents and Settings>
```

### Check Cable

#### When using Ethernet

- In order to check whether the problem is due to the LAN cable, connect the cable connected to the printer to other terminals or the PC to confirm whether its operation is normal.

#### When using WLAN

- It is recommended to use the USB extended cable provided by BIXOLON.
- Connect the USB extended cable and WLAN dongle to other terminals or the PC and confirm whether recognition operation is normal.
- Check whether WLAN USB adaptor uses the Ralink RT73 chipset. WLAN USB adaptors that use chipsets other than RT73 of Ralink won't work when it is connected to Printer.