

MULTI-FUNCTION SENSORS



- *Sensitivity adjustment and Stability LED*
- *Free voltage power supply and relay output*
- *10-30 Vdc power supply with NPN and PNP outputs*
- *Versions with 5 timing functions*

S2 SERIES

The photoelectric sensors of the **S2** series are enclosed in sturdy plastic housings, developed to guarantee the complete protection of the control panel and connection terminals.

The free voltage versions present a relay output, while the 10-30 Vdc versions have a double NPN and PNP output, both available with 1 or 2 m proximity, 5 m polarised retroreflex, 3 m polarised retroreflex and 10 or 50 m through beam optic functions.

The red output LED and the green stability LED are visible through the IP66 hermetically-sealed cover, that also protects the terminal block and commands, such as the sensitivity adjustment trimmer and dark/light operating mode selector. The versions with output timing present a trimmer to regulate the time up to 16 s. and a selector to set 5 different functions.

TECHNICAL DATA

Power supply:	10 ... 30 Vdc, reverse polarity protection 15 ... 264 Vac/Vdc
Consumption:	30 mA max. (d.c. vers.) 3 VA max. (a.c. vers.)
Light emission:	infrared LED 880 nm red LED 660 nm (B vers.)
Diffuse proximity operating distance:	1 ... 90 cm (C90 vers.) 1 ... 200 cm (C200 vers.)
Retroreflex operating distance:	0.1 ... 5 m (on R2)
Polarised retroreflex operating distance: ..	0.15 ... 3 m (on R2)
Through beam operating distance:	0 ... 10 m (G10/F10 vers.) 0 ... 50 m (G50/F50 vers.)
Setting:	sensitivity trimmer
Indicators:	red OUTPUT LED green STABILITY LED
Output type:	NPN and PNP, open collector (d.c. vers.) or relay 1 NO contact (a.c. vers.)
Saturation voltage:	1 V max. (NPN vers.) 2 V max. (PNP vers.)
Output current:	100 mA max., short-circuit protection relay 1 A (250 Vac), resistive load
Response time:	1 ms max. (d.c. vers.) 20 ms max. (a.c. vers.)
Switching frequency:	500 Hz max. (d.c. vers.) 25 Hz max. (a.c. vers.)
Timing function:	normal, ON-delay, OFF-delay, ON/OFF- delay, one-shot all adjustable from 0.6 to 16 sec.
Operating mode:	dark/light selectable
Connection:	terminal block with 4 screw terminals gland for cables with 8 to 10 mm diameter
Electrical protection:	class 1 (a.c. vers.) class 2 (d.c. vers.)
Mechanical protection:	IP66
Housing material:	PBT plastic
Lens material:	PMMA plastic
Weight:	100 g max.
Operating temperature:	-25 ... +55°C
Storage temperature:	-25 ... +70°C
Reference standard:	EN 60947-5-2
Certifications:	CE

DETECTION DIAGRAMS

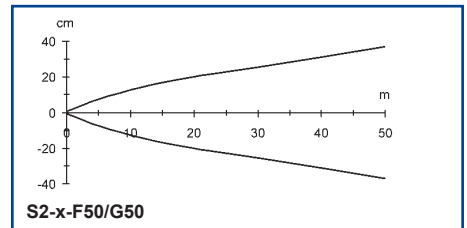
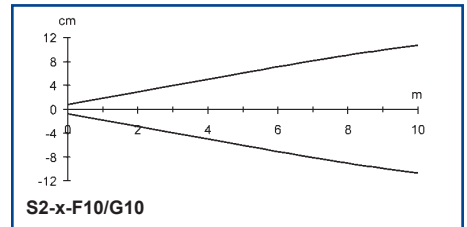
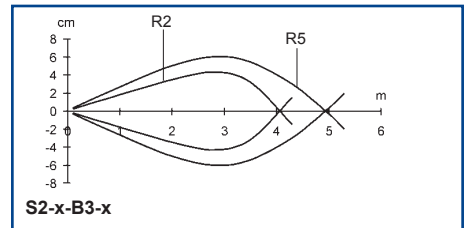
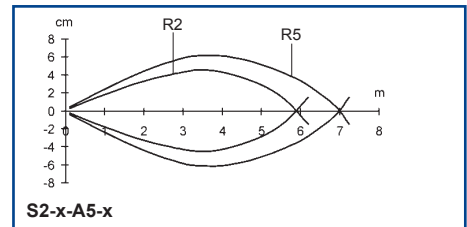
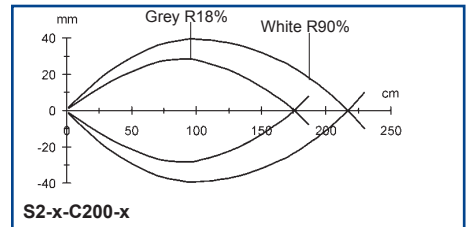
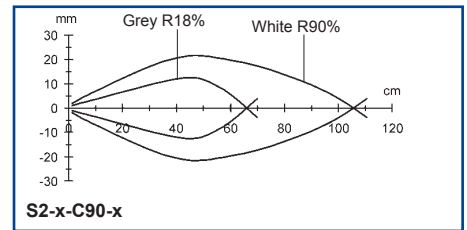

The operating distances indicate the detection distance with excess gain 2.

The detection diagrams indicate the typical operating distance with excess gain 1.

CONNECTIONS

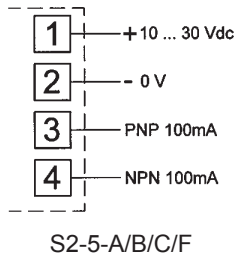

S2-5-A/B/C/F

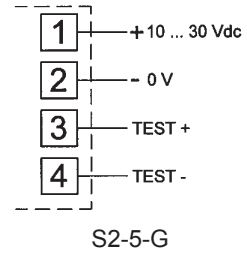

S2-5-G

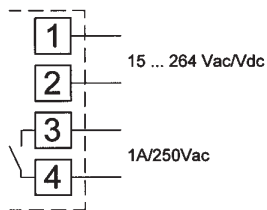

S2-1-A/B/C/F

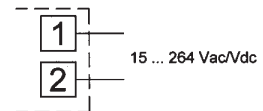

S2-1-G

DIMENSIONS

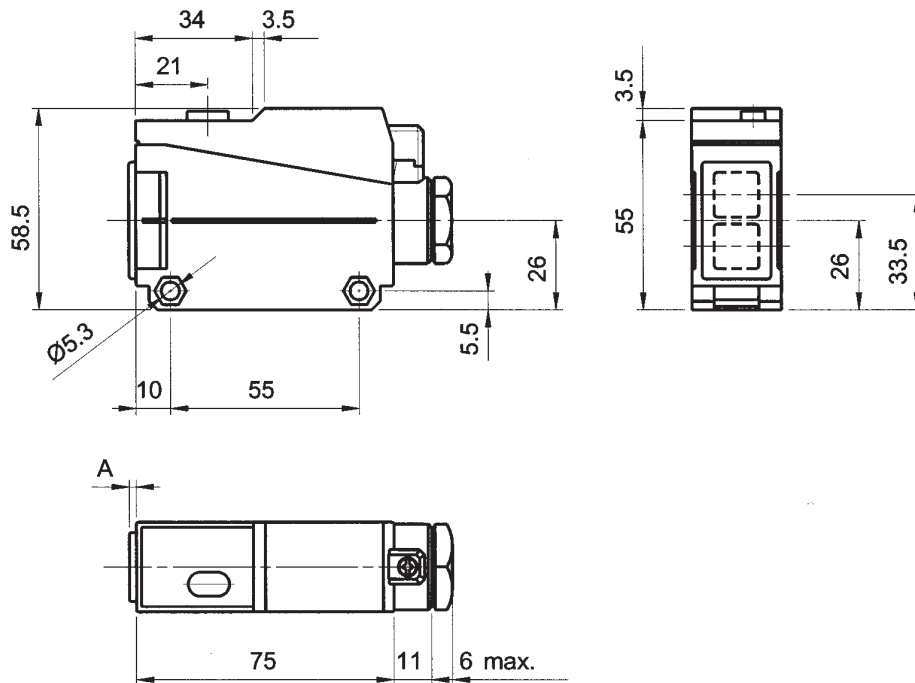

MODELS

VERSIONS WITH 15 ... 264 Vac/Vdc POWER SUPPLY

MODEL	FUNCTION	OUTPUT	CODE N°
S2-1-C90	proximity	relay	J950530390
S2-1-C90T	proximity	relay with timer	J950535390
S2-1-C200	proximity	relay	J950530393
S2-1-C200T	proximity	relay with timer	J950535393
S2-1-A5	retroreflex	relay	J950330390
S2-1-A5T	retroreflex	relay with timer	J950335390
S2-1-B3	polarised retroreflex	relay	J950320390
S2-1-B3T	polarised retroreflex	relay with timer	J950325390
S2-1-F10	receiver	relay	J950200390
S2-1-F10T	receiver	relay with timer	J950205390
S2-1-F50	receiver	relay	J950200394
S2-1-F50T	receiver	relay with timer	J950205394
S2-1-G10	emitter	-	J950139990
S2-1-G50	emitter	-	J950139995

VERSIONS WITH 10 ... 30 Vdc POWER SUPPLY

MODEL	FUNCTION	OUTPUT	CODE N°
S2-5-C90	proximity	NPN/PNP	J950530000
S2-5-C90T	proximity	NPN/PNP with timer	J950535000
S2-5-C200	proximity	NPN/PNP	J950530003
S2-5-C200T	proximity	NPN/PNP with timer	J950535003
S2-5-A5	retroreflex	NPN/PNP	J950330000
S2-5-A5T	retroreflex	NPN/PNP with timer	J950335000
S2-5-B3	polarised retroreflex	NPN/PNP	J950320000
S2-5-B3T	polarised retroreflex	NPN/PNP with timer	J950325000
S2-5-F10	receiver	NPN/PNP	J950200000
S2-5-F10T	receiver	NPN/PNP with timer	J950205000
S2-5-F50	receiver	NPN/PNP	J950200004
S2-5-F50T	receiver	NPN/PNP with timer	J950205004
S2-5-G10	emitter	-	J950139900
S2-5-G50	emitter	-	J950139905

ACCESSORIES

MODEL	DESCRIPTION	CODE N°
ST-511	1 pc fixing bracket	95ACC1310
S2-SLIT	3x10 mm slit	J8205000

Please refer also to *Sensor Accessories*

Distributed by:

HEADQUARTERS

DATASENSOR SpA
 via Lavino, 265 - 40050 Monte San Pietro, BO - Italy
 Tel. +39 051/6765611 • Fax +39 051/6759324
 www.datasensor.com • e-mail info@datasensor.com

Datasensor SpA endeavours to continuously improve and renew its products; for this reason the technical data and contents of this catalogue may undergo variations without prior notice. For correct installation and use Datasensor SpA can guarantee only the data indicated in the instruction manual supplied with the products.