



## AS1

### AREAscan™ high-resolution detection photoelectric light grids

- Crossed beam area sensors
- 100mm controlled height
- Adjustment trimmer
- Optical or wire synchronism
- Scan Mode input

#### APPLICATIONS

- Processing lines
- Food, Cosmetic and Pharmaceutical
- Electronics and mechanical assembling
- Conveyor lines and sorting systems



SENSORS

| AS1                         |           |   |
|-----------------------------|-----------|---|
| Area sensing                |           | 100 mm  |
| Operating Distance          |           | 0,3...2,1 m (AS1-LD)<br>0,8...3 m (AS1-HD)  |
| Resolution                  |           | Flat: 0,2x75mm Cylindrical: Ø 6mm (AS1-HR)<br>Flat: 0,2x200mm Cylindrical: Ø18mm (AS1-SR) |
| Response Time               |           | 1,75 ms (AS1-SR)<br>2,75...8 ms (AS1-HR)  |
| Light emission              |           | IR LED  |
| Power supply                | Vdc       | 24 V  |
|                             | Vac       |   |
|                             | Vac/dc    |   |
| Output                      | PNP       | ▪   |
|                             | NPN       |   |
|                             | NPN/PNP   |   |
|                             | relay     |   |
|                             | other     |   |
| Connection                  | cable     |   |
|                             | connector | ▪   |
|                             | pig-tail  |   |
| Approximate dimensions (mm) |           | 22x43x150   |
| Housing material            |           | aluminium   |
| Mechanical protection       |           | IP65  |

| TECHNICAL DATA                    |  |
|-----------------------------------|--|
| Power supply                      | 24 Vdc $\pm$ 15%   |
| Consumption on emitter unit (TX)  | 150 mA max.  |
| Consumption on receiver unit (RX) | 40 mA max. load excluded   |
| Light emission                    | IR LED 880 nm  |
| Setting                           | adjustment trimmer (mod. AS1...P)                                      |
| Indicators                        | yellow OUTPUT LED<br>green POWER ON LED                                |
| Output                            | PNP  |
| Output current                    | 100 mA max.  |
| Saturation voltage                | 1,5 V max.   |
| Response time                     | 2,75 - 8 ms (mod. AS1-HR)<br>1,75 ms (mod. AS1-SR)                     |
| Connection                        | M12 4-pole connector (TX), M12 5-pole connector (RX)                   |
| Dielectric strength               | 500 Vac, 1 min between electronics and housing                         |
| Insulating resistance             | >20 M $\Omega$ , 500 Vdc between electronics and housing               |
| Mechanical protection             | IP65 (EN 60529)  |
| Vibrations                        | 0,5 mm amplitude, 10 ... 55 Hz frequency, for every axis (EN60068-2-6) |
| Shock resistance                  | 11 ms (30 G) 6 shock for every axis (EN60068-2-27)                     |
| Housing material                  | black electro-painted aluminium  |
| Lens material                     | PMMA   |
| Operating temperature             | 0 ... 50 °C  |
| Storage temperature               | -25 ... 70 °C  |
| Weight                            | 300 g  |

## DIMENSIONS

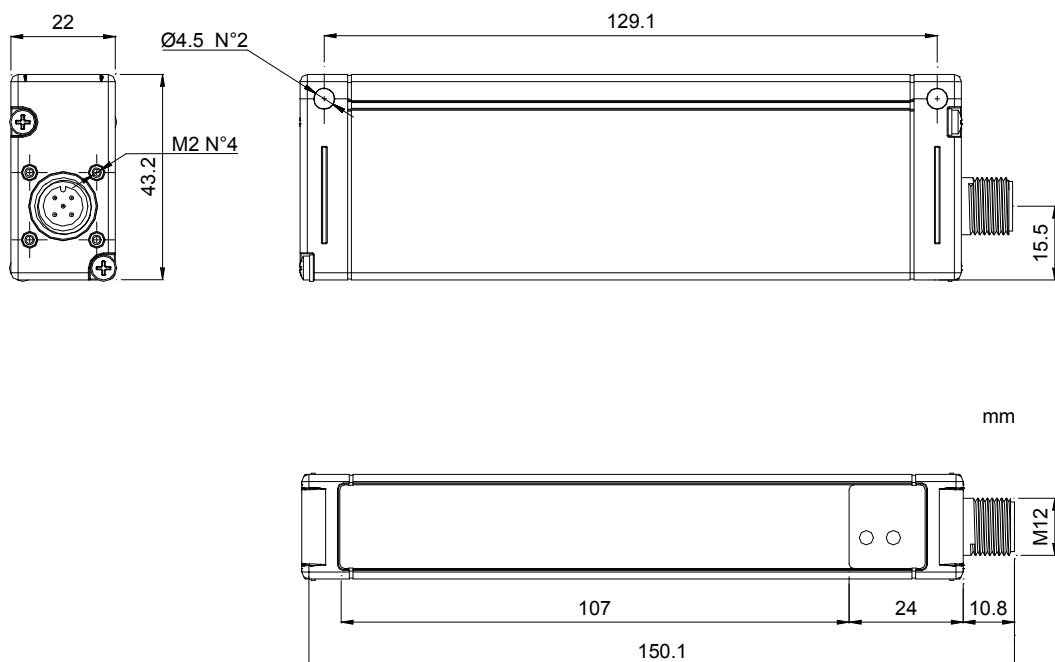

## INDICATORS AND SETTINGS

Two different models are available: high resolution (AS1-HR) or standard resolution (AS1-SR). In the first case the light array has 16 beams, while in the second case the beams are reduced to 6. In the AS1-HR model, the selection inputs of the SCAN MODE, can configure 4 different crossed-beam scanning modes. These different modes allow to vary the detection performances, in particular the resolution can be increased to 0.2mm thickness, or the response time up to less than 3ms.

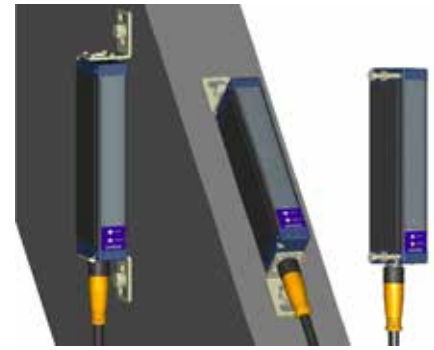

## INDICATORS AND SETTINGS (TRIMMER VERSIONS)

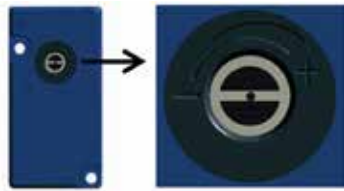

Emitter is equipped with a manual regulation which lets the user change the emission power by means of a screwdriver.

The emission power reduction can be particularly useful to lower passive reflections when maximum operating distance it is not required.

## CONNECTIONS

### M12 CONNECTOR

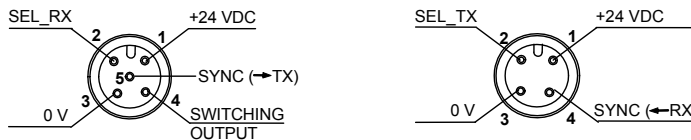

|   |            | AS1-HR           | AS1-SR           |  |            | AS1-HR  | AS1-SR   |
|---|------------|------------------|------------------|--|------------|---------|----------|
| <b>RECEIVER (RX):</b><br>M12 5-pole connector | 1 - brown: | +24 VDC          | +24 VDC          | <b>EMITTER (TX):</b><br>M12 4-pole connector | 1 - brown: | +24 VDC | +24 VDC  |
|   | 2 - white: | SEL_RX           | Not used         |  | 2 - white: | SEL_TX  | Not used |
|   | 3 - blue:  | 0 V              | 0 V              |  | 3 - blue:  | 0 V     | 0 V      |
|   | 4 - black: | Switching output | Switching output |  | 4 - black: | SYNC ** | SYNC *   |
|   | 5 - grey:  | SYNC *           | SYNC *           |  |            |         |          |

\* not used in trimmer version  
\*\* SEL\_TX2 in trimmer version

## HIGH RESOLUTION SCANNING MODE

| PROG. N° | SEL_RX         | SEL_TX         | RESOLUTION | RESPONSE TIME (msec) |
|----------|----------------|----------------|------------|----------------------|
| 1        | 0 Vdc or FLOAT | 0 Vdc or FLOAT | LOW        | 2.75                 |
| 2        | 0 Vdc or FLOAT | 24 Vdc         | M/L        | 3                    |
| 3        | 24 Vdc         | 0Vdc or FLOAT  | M/H        | 7.75                 |
| 4        | 24 Vdc         | 24 Vdc         | HIGH       | 8                    |

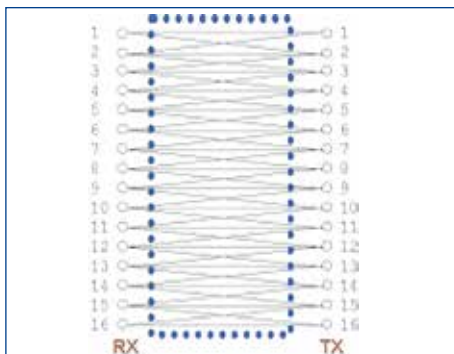

**Scan mode 1:**  
high speed / low resolution  
Minimum object detection  
Flat = 0.4 (thickness) x 100 (width) mm  
Cylindrical objects = Ø 6 mm

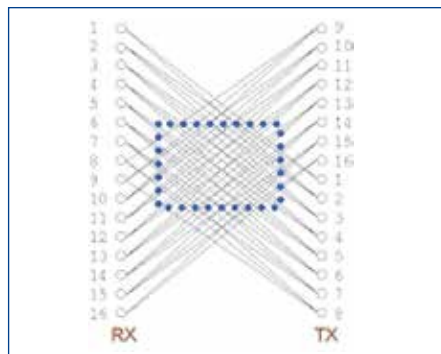

**Scan mode 2:**  
high speed / mid resol. central area  
Minimum object detection  
Flat = 0.4 (thickness) x 90 (width) mm  
Cylindrical objects = Ø 6 mm

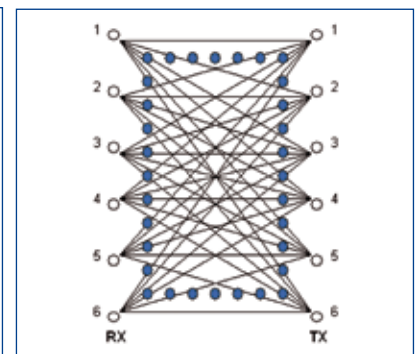

**Scan mode 3-4:**  
low speed / high resolution  
Minimum object detection  
Flat = 0.2 (thickness) x 75 (width) mm  
Cylindrical objects = Ø 6 mm

## STANDARD RESOLUTION SCANNING MODE

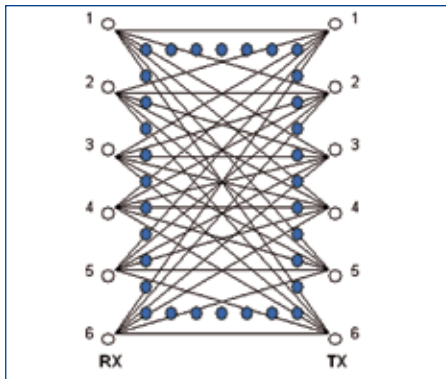

Minimum object detection  
 Flat = 0.2 (thickness) x 200 (width) mm  
 Cylindrical objects =  $\varnothing$  18 mm

Note: the scan mode is fixed in the standard resolution version.

## MODEL SELECTION AND ORDER INFORMATION

| OPTIC FUNCTION | OPERATING DISTANCE | RESOLUTION | SETTING            | MODEL           | ORDER No. |
|----------------|--------------------|------------|--------------------|-----------------|-----------|
| Area sensor    | 2 m                | High       | n/a                | AS1-LD-HR-010-J | 958101000 |
|                |                    |            | Adjustment Trimmer | AS1-LD-HR-010-P | 958101040 |
|                |                    | Standard   | n/a                | AS1-LD-SR-010-J | 958101010 |
|                |                    |            | Adjustment Trimmer | AS1-LD-SR-010-P | 958101050 |
|                | 3 m                | High       | n/a                | AS1-HD-HR-010-J | 958101020 |
|                |                    | Standard   |                    | AS1-HD-SR-010-J | 958101030 |

## CABLES

| TYPE                | DESCRIPTION                 | LENGTH        | MODEL         | ORDER No. |
|---------------------|-----------------------------|---------------|---------------|-----------|
| Axial M12 Connector | 4-pole, grey, P.V.C.        | 3 m           | CS-A1-02-G-03 | 95A251380 |
|                     |                             | 5 m           | CS-A1-02-G-05 | 95A251270 |
|                     |                             | 10 m          | CS-A1-02-G-10 | 95A251390 |
|                     | 4-pole, U.L., black, P.V.C. | 3 m           | CS-A1-02-U-03 | 95ASE1120 |
|                     |                             | 5 m           | CS-A1-02-U-05 | 95ASE1130 |
|                     |                             | 10 m          | CS-A1-02-U-10 | 95ASE1140 |
|                     |                             | 15 m          | CS-A1-02-U-15 | 95ASE1150 |
|                     |                             | 25 m          | CS-A1-02-U-25 | 95ASE1160 |
|                     | 5-pole, grey, P.V.C.        | 3 m           | CS-A1-03-G-03 | 95ACC2110 |
|                     |                             | 5 m           | CS-A1-03-G-05 | 95ACC2120 |
|                     |                             | 10 m          | CS-A1-03-G-10 | 95ACC2140 |
|                     | 5-pole, U.L., black, P.V.C. | 3 m           | CS-A1-03-U-03 | 95ASE1170 |
|                     |                             | 5 m           | CS-A1-03-U-05 | 95ASE1180 |
|                     |                             | 10 m          | CS-A1-03-U-10 | 95ASE1190 |
|                     |                             | 15 m          | CS-A1-03-U-15 | 95ASE1200 |
|                     |                             | 25 m          | CS-A1-03-U-25 | 95ASE1210 |
| 50 m                |                             | CS-A1-03-U-50 | 95A252700     |           |