

manuale d'installazione ed uso • installation and use manual • installations- und bedienungsanleitung
manuel d'installation et d'utilisation • manual de instalación y uso

SENTINEL PRO

SEP 700-1000-1500-2200-3000
SEP 1000-2200-3000 ER



INTRODUCTION

Congratulations on purchasing a **UPS Sentinel Pro** product and welcome to **Riello UPS!** To use the support service offered by **Riello UPS**, visit the site **www.riello-ups.com**

The company is highly specialised in the development and production of uninterruptible power supplies (UPSs). The UPSs in this series are high-quality products, carefully designed and manufactured in order to ensure the highest levels of performance.

This device can be installed by anyone on the condition that he/she has **READ THE USER AND SAFETY MANUAL CAREFULLY.**

The UPS and the Battery Box internally generate DANGEROUS electrical voltages. All maintenance operations must be carried out SOLELY by qualified operators.

This manual contains detailed instructions for using and installing the UPS and the Battery box.

For information about using and making the most of the performance of your device, please keep hold of the CD containing this manual and read it carefully before operating the equipment.

ENVIRONMENTAL PROTECTION

In the development of its products, the company devotes abundant resources to analysing the environmental aspects. All our products pursue the objectives defined in the environmental management system developed by the company in compliance with applicable standards.

No hazardous materials such as CFCs, HCFCs or asbestos are used in this product.

When evaluating packaging, the choice of material has been made favouring recyclable materials.

For correct disposal, please separate and identify the type of material of which the packaging is made in the table below. Dispose of all material in compliance with applicable standards in the country in which the product is used.

DESCRIPTION	MATERIAL
Box	Cardboard
Packaging corner	Stratocell
Protective bag	Polythene
Accessories bag	Polythene

DISPOSING OF THE PRODUCT

The UPS and the Battery Box contain electronic cards and batteries which are considered TOXIC and HAZARDOUS waste. When the product reaches the end of its operating life, dispose of it in accordance with applicable local legislation. Disposing of the product correctly contributes to respecting the environment and personal health.

© The reproduction of any part of this manual, in whole or in part, is forbidden without the prior consent of the manufacturer. In order to make improvements, the manufacturer reserves the right to modify the product described at any moment and without notice.

CONTENTS

PRESENTATION	5
<i>UPS VIEWS</i>	6
<i>FRONT VIEW</i>	6
<i>REAR VIEW</i>	6
<i>DISPLAY PANEL VIEW</i>	8
<i>BATTERY BOX (ACCESSORY NOT PROVIDED WITH UPS)</i>	9
<i>REAR VIEW</i>	9
INSTALLATION	10
<i>INITIAL CONTENT CHECK</i>	10
<i>INSTALLATION ENVIRONMENT</i>	11
<i>BATTERY BOX INSTALLATION</i>	11
<i>SETTING THE NOMINAL BATTERY CAPACITY</i>	11
USE	12
<i>CONNECTIONS AND SWITCHING ON FOR THE FIRST TIME</i>	12
<i>SWITCHING ON FROM THE MAINS</i>	12
<i>SWITCHING ON FROM THE BATTERY</i>	12
<i>SWITCHING OFF THE UPS</i>	12
<i>DISPLAY PANEL MESSAGES</i>	13
<i>UPS STATUS MESSAGES</i>	13
<i>MEASUREMENT DISPLAY AREA</i>	14
<i>CONFIGURING THE OPERATING MODE</i>	15
<i>POSSIBLE SETTINGS</i>	15
<i>ADDITIONAL FUNCTIONS</i>	15
<i>SOFTWARE</i>	17
<i>MONITORING AND CONTROL SOFTWARE</i>	17
<i>CONFIGURATION SOFTWARE</i>	17
<i>UPS CONFIGURATION</i>	18
<i>COMMUNICATION PORTS</i>	20
<i>RS232 CONNECTOR</i>	20
<i>COMMUNICATION SLOT</i>	20

<i>TROUBLESHOOTING</i>	<i>21</i>
<i>ALARM CODES</i>	<i>23</i>
<i>FAULT</i>	<i>23</i>
<i>LOCK</i>	<i>24</i>
<i>TECHNICAL DATA</i>	<i>25</i>

PRESENTATION

SENTINEL PRO uses ON-LINE double conversion technology, resulting in the highest levels of reliability and maximum protection for critical loads such as servers, IT applications and Voice/Data.

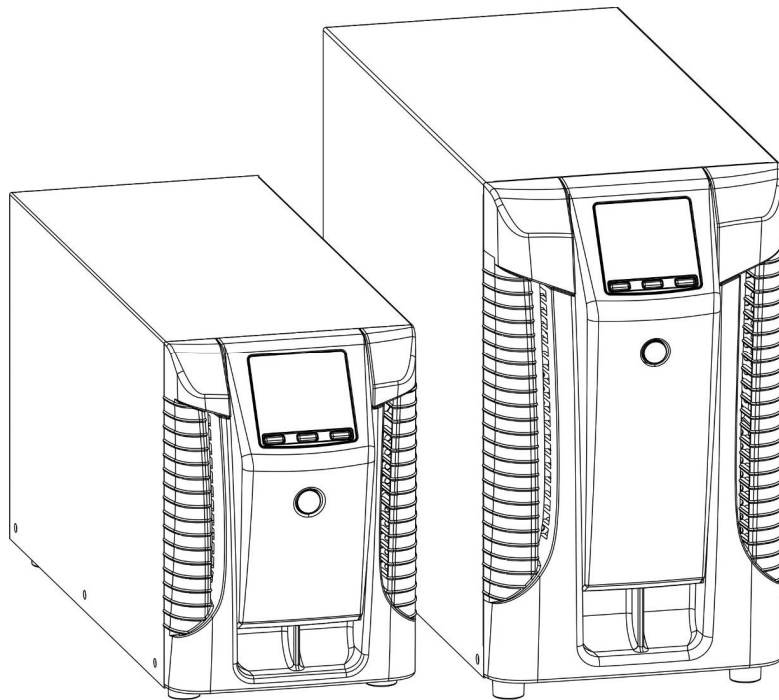

It is possible to use one or more autonomy expansion units known as **BATTERY BOXES** (optional accessories) with the same dimensions and aesthetic line as the UPS alongside it.

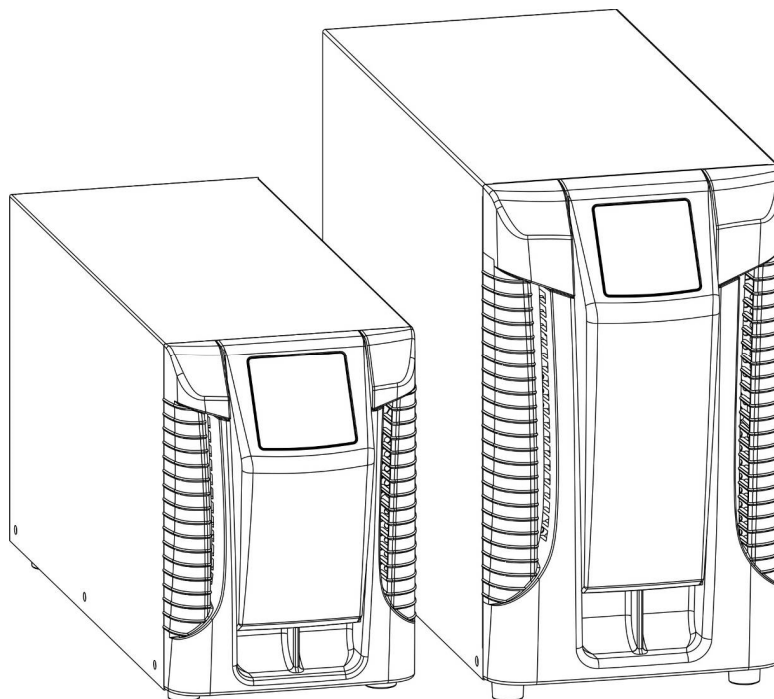

The **ER model** UPSs fitted with upgraded battery chargers are the solution for Business Continuity applications which require long battery-powered operating times. For these versions, the batteries are housed in separate cabinets which are designed to contain large, high-capacity batteries.

UPS VIEWS

FRONT VIEW

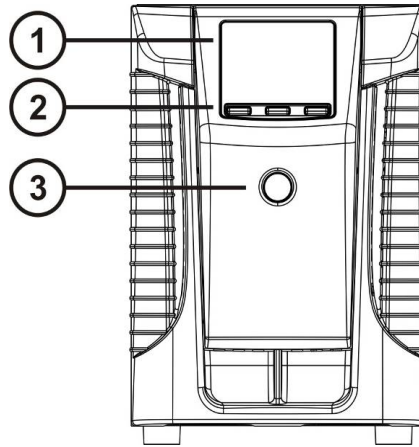

REAR VIEW

700VA / 1500VA model

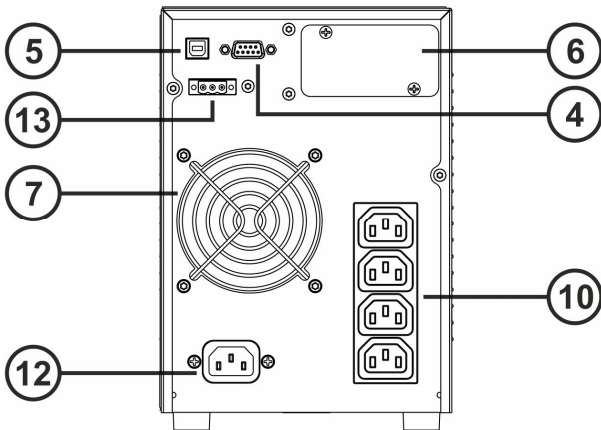

1000VA / 1000VA ER model

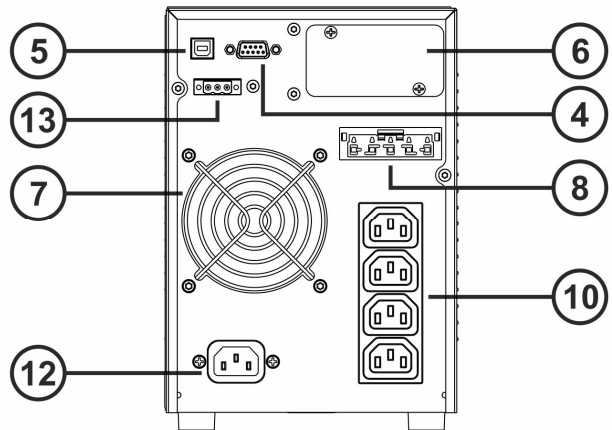

- ① Display
- ② Multipurpose buttons
- ③ ON/OFF switch
- ④ RS232 communication port and contacts
- ⑤ USB communication port
- ⑥ Slot for communication cards

- ⑦ Cooling fans
- ⑧ Battery expansion connector
- ⑩ IEC 10A output socket
- ⑫ IEC 10A input plug
- ⑬ Remote control terminal board

2200VA / 2200VA ER / 3000VA / 3000VA ER model

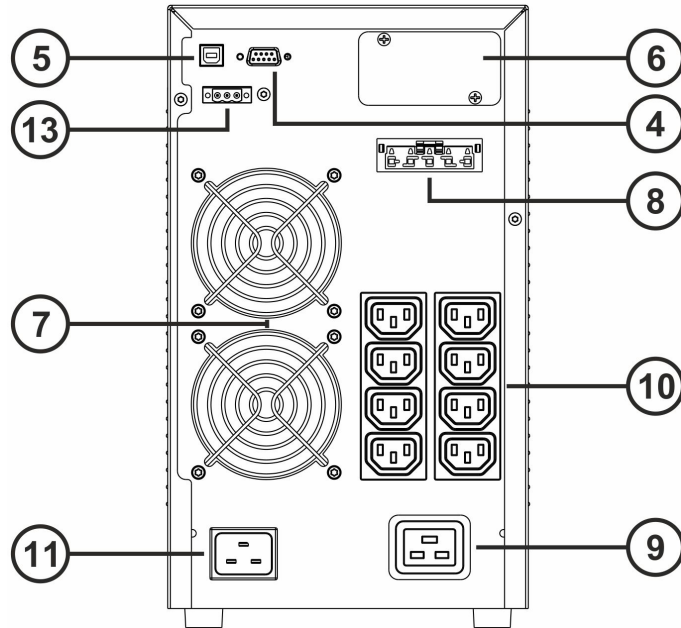

- | | | | |
|---|---------------------------------------|---|--|
| ④ | RS232 communication port and contacts | ⑨ | IEC 16A output socket (only for 3000VA models) |
| ⑤ | USB communication port | ⑩ | IEC 10A output socket |
| ⑥ | Slot for communication cards | ⑪ | IEC 16A input plug |
| ⑦ | Cooling fans | ⑬ | Remote control terminal board |
| ⑧ | Battery expansion connector | | |

DISPLAY PANEL VIEW

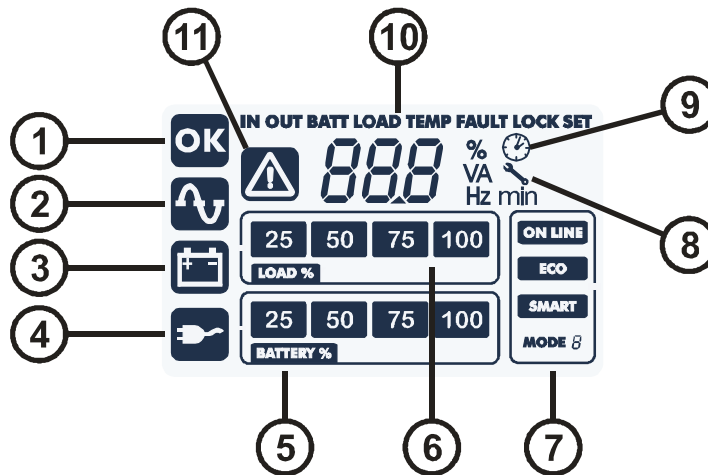

- | | |
|--------------------------|----------------------------|
| Ⓐ "SEL" button (Select) | Ⓔ Battery charge indicator |
| Ⓑ "ON" button | Ⓕ Load level indicator |
| Ⓒ "STAND-BY" button | Ⓖ Configuration area |
| ① Regulation operation | ⑧ Maintenance request |
| ② Mains operation | ⑨ Timer |
| ③ Battery operation | ⑩ Measurement display area |
| ④ Load powered by bypass | ⑪ Stand-by / alarm |

BATTERY BOX (ACCESSORY NOT PROVIDED WITH UPS)

The BATTERY BOX is an optional accessory dedicated to this range of UPSs (same dimensions and aesthetic line). The BATTERY BOX contains batteries which allow the operating time of the uninterruptible power supplies to be increased during extended blackouts. The number of batteries contained can vary according to the type of UPS for which the BATTERY BOX is intended. It is therefore necessary to take great care to ensure that the battery voltage of the BATTERY BOX is the same as the voltage permitted by the UPS.

It is possible to connect further BATTERY BOXES in order to create a chain, suitable for achieving any autonomy time without mains power.

REAR VIEW

36V Battery Box

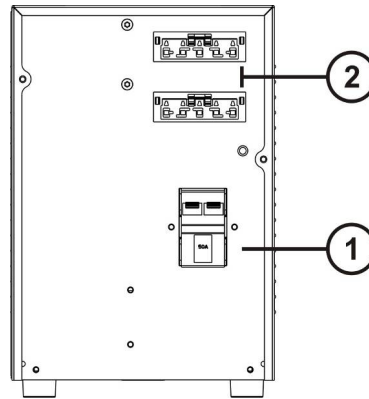

72V Battery Box

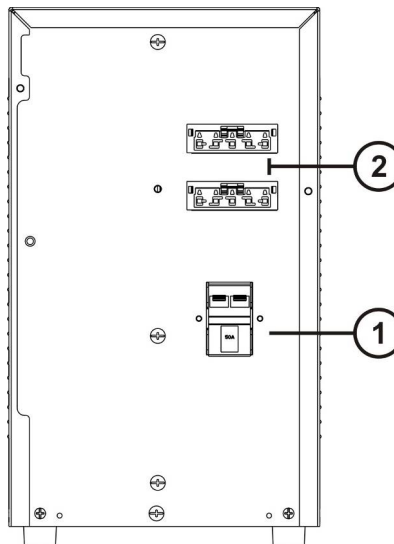

① Battery disconnecter (SWBATT)

② Battery expansion connector

INSTALLATION

INITIAL CONTENT CHECK

After opening the packaging, it is first necessary to check the contents.
The package must contain:

UPS

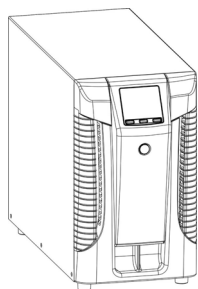

Schuko power cable - IEC 10A (for 700VA / 1000VA / 1500VA models); Schuko power cable - IEC 16A (for 2200VA / 3000VA models)

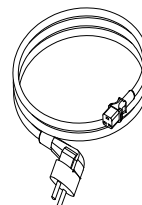

IEC 10A connection cable

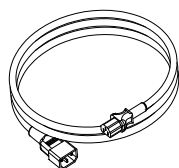

IEC 16A male plug
(For 3000VA models only)

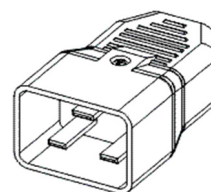

USB cable

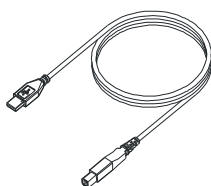

User manual CD + Safety manual

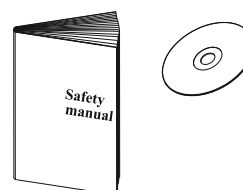

Battery expansion plug
(ER version only)

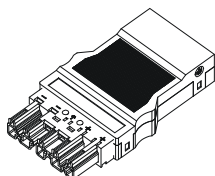

INSTALLATION ENVIRONMENT

The UPS and the Battery Box must be installed in ventilated, clean environments which are sheltered from bad weather. The relative humidity in the environment must not exceed the maximum values shown in the Technical Data table. The ambient temperature, whilst the UPS is in operation must remain between 0 and 40°C, and the UPS must not be positioned in places which are exposed to direct sunlight or to hot air.



The recommended operating temperature for the UPS and the batteries is between 20 and 25°C. The actual operating life of the batteries is 5 years on average with an operating temperature of 20°C. If the operating temperature reaches 30°C, the operating life is halved.



This is a category C2 UPS product. In a residential environment, this product may cause radio interference, in which case the user may be required to take additional measures.

BATTERY BOX INSTALLATION



CAUTION:
CHECK THAT THE BATTERY BOX VOLTAGE IS THE SAME AS THE VOLTAGE PERMITTED BY THE UPS.
CHECK THE RATING ON THE BACK OF THE DEVICE.

It is possible to connect more than one Battery Box in order to achieve any level of autonomy without mains power. Connect any Battery Boxes in a cascade as shown in the figure below:

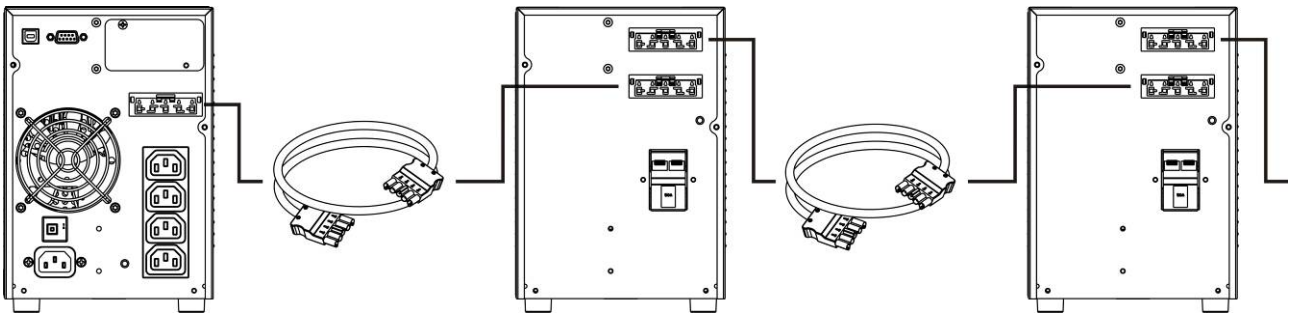

SETTING THE NOMINAL BATTERY CAPACITY

Before installing one or more Battery Boxes the UPS must be configured in order to update the nominal capacity value (total Ah UPS's internal batteries + external batteries) using the dedicated configuration software **UPSTools**. The battery box must be installed while the UPS is switched off and disconnected from the main.



CAUTION:

The connection cables cannot be extended by the user.

After connecting the UPS to its Battery Boxes, insert the fuses and turn the Battery Box battery isolators (SWBATT) to the ON position.

It is not possible to connect more than one UPS to a single battery box, or to several Battery Boxes connected in a series.



To check whether a new version of the most up-to-date software is available, consult the website: **www.riello-ups.com**.

CONNECTIONS AND SWITCHING ON FOR THE FIRST TIME

- 1) Check that there is a protection device against overcurrents and short circuits in the system upstream from the UPS. The recommended protection value is 10A (for the 700VA, 1000VA and 1500VA versions) and 16A (for the 2200VA, 3000VA and ER versions) with a B or C trip curve.
- 2) Power the UPS using the input cable provided.
- 3) Press the ON/OFF switch located on the front panel.
- 4) After a few moments, the UPS will switch on, the display will light up, there will be a beep and the  icon will start to flash. The UPS is in stand-by mode: meaning that it is only consuming a small amount of power. The microcontroller is powered which supervises the self-diagnoses; the batteries are charging; everything is ready for UPS activation. Battery operation is also in stand-by mode provided that the timer is active.
- 5) Connect the equipment to be powered to the sockets on the back of the UPS, using the cable supplied or a cable no longer than 10 metres.
CAUTION: do not connect equipment which absorbs more than 10A to the IEC 10A sockets. For equipment which exceeds this level of absorption, use the IEC 16A socket only (available on the 3000VA version).
- 6) Check which operating mode is set on the display and, if necessary, see the “**Configuring operating modes**” paragraph to set the required mode. For advanced UPS configurations execute the software UPSTools which can be downloaded from the web site www.riello-ups.com.

SWITCHING ON FROM THE MAINS

- 1) Press the “ON” button for 1 second. After pressing it, all the icons on the display light up for 1 second and the UPS beeps.
- 2) Switch on the equipment connected to the UPS.

When switching on for the first time only: after 30 seconds, check that the UPS is operating correctly:

- 1) Simulate a blackout by disconnecting power to the UPS.
- 2) The load must continue to be powered, the  icon on the display must light up and there must be a beep every 4 seconds.
- 3) When power is reconnected, the UPS must go back to operating from the mains.

SWITCHING ON FROM THE BATTERY

- 1) Press the ON/OFF switch located on the front panel.
- 2) Hold down the “ON” button for at least 5 seconds. All the icons on the display light up for 1 second.
- 3) Switch on the equipment connected to the UPS.

SWITCHING OFF THE UPS









In order to switch off the UPS, hold down the “STBY” button for at least 2 seconds. The UPS goes back to stand-by mode and the  icon starts to flash:

- 1) If the mains power is present, the ON/OFF switch must be pressed to completely turn off the UPS.
- 2) During battery mode operation with the timer not set, the UPS automatically switches off after 30 seconds. If, on the contrary, the timer is set, press and hold down the “STBY” key for at least 5 seconds to turn off the UPS. For complete shutdown, press the ON/OFF switch.

DISPLAY PANEL MESSAGES

This chapter describes, in detail, the various information that can be displayed on the LCD.

UPS STATUS MESSAGES

ICON	STATUS	DESCRIPTION
	Fixed	Indicates a fault
	Flashing	The UPS is in stand-by mode
	Fixed	Indicates regular operation
	Fixed	The UPS is operating from the mains
	Flashing	The UPS is operating from the mains, but the output voltage is not synchronised with the mains voltage
	Fixed	The UPS is operating from the battery. In this condition, the UPS emits an acoustic signal (beep) at regular 4-second intervals.
	Flashing	Low battery pre-alarm. Indicates that battery autonomy is coming to an end. In this condition, the UPS emits a beep at regular 1-second intervals.
	Fixed	Indicates that the loads connected to the UPS are powered by the bypass
	Dynamic	Indicates the estimated percentage charge of the batteries
	Dynamic	Indicates the percentage of charge applied to the UPS compared with the nominal value.
	Flashing	Maintenance is required. Contact the support centre.
	Fixed	Indicates that the timer is active (programmed switch-on and switch-off). The timer can be activated/deactivated using the software provided.
	Flashing	1 minute until the UPS switches back on or 3 minutes until it switches off

MEASUREMENT DISPLAY AREA











It is possible to display the most important measurements regarding the UPS in sequence on the display.

When the UPS is switched-on, the display shows the main voltage value.

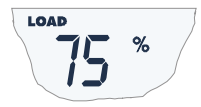
To display a different measurement, press the "SEL" button repeatedly until the desired measurement appears.

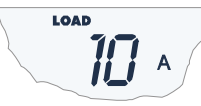
In the event of a fault/alarm (FAULT) or a lock (LOCK), the display will automatically show the type and code of the corresponding alarm.

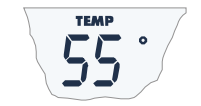
Some examples are shown below:

GRAPHIC EXAMPLE ⁽¹⁾	DESCRIPTION	GRAPHIC EXAMPLE ⁽¹⁾	DESCRIPTION
	Mains voltage		Battery charge percentage
	Mains frequency		Total battery voltage
	UPS output voltage		Applied load percentage
	Output voltage frequency		Current absorbed by the load
	Residual battery autonomy		Temperature of the electronics cooling system inside the UPS
	Fault / Alarm ⁽²⁾ : the corresponding code is displayed		Lock ⁽²⁾ : the corresponding code is displayed

⁽¹⁾ The values shown in the images in the table are purely as an indication.

⁽²⁾ The FAULT / LOCK codes can only be displayed if they are active (presence of a fault/alarm or a lock).

CONFIGURING THE OPERATING MODE

The area of the display shown in the figure displays the active operating mode and allows the user to choose other modes directly from the display panel.



HOW TO PROCEED:

- To access the configuration area, hold down the “SEL” button for at least 3 seconds.
- The icon corresponding to the mode currently set lights up.
- To change the mode, press the “ON” button.
- To confirm the mode chosen, hold down the “SEL” button for at least 3 seconds.

POSSIBLE SETTINGS

The UPS is designed to be configured in various operating modes:

- **ON-LINE** is the mode with the greatest load protection and the best quality of the output waveform (*)
- **ECO** is the mode with which the UPS consumes the least power, so is therefore the most efficient (**)
- **SMART ACTIVE:** in this mode, the UPS decides whether to operate in ON-LINE or ECO mode according to a statistic about the quality of the mains power.
- **STAND-BY OFF [Mode 1]:** the UPS operates as an emergency power supply. If mains power is present, the load is not powered, however should the mains supply fail, the load is powered by the UPS.

(*) The effective value (rms) of the output frequency and voltage is constantly controlled by the microprocessor, independently from the waveform of the mains voltage, maintaining the output frequency synchronised to the mains within a configurable range.
Outside this range, the UPS output de-synchronises from the mains supply, moving to the nominal frequency; in this condition, the UPS cannot use the bypass.

(**) In order to optimise performance, in ECO mode, the load is normally powered by the bypass. If the mains goes out of the permitted tolerance range, the UPS switches to ON LINE operation. If the mains returns within the permitted tolerance range for at least five minutes, the UPS goes back to powering the load from the bypass.

ADDITIONAL FUNCTIONS

MANUAL BYPASS

Using the Manual Bypass feature, the UPS can be switched to bypass. In this condition the load is powered directly by the input mains, any disruption in the mains directly affects the load.



CAUTION:
BEFORE CARRYING OUT THE FOLLOWING SEQUENCE OF OPERATIONS, ENSURE THAT THE UPS'S INPUT AND OUTPUT FREQUENCY COINCIDE AND THAT THE UPS IS NOT OPERATING FROM THE BATTERY

Attention: even when the UPS is switched on, the load is disconnected in the event of a mains blackout.

If the input mains deviates from the established tolerances, the UPS automatically switches to Stdby mode and disconnects the load.

To force the UPS into manual bypass mode, press and hold down the ON and SEL keys simultaneously for at least 4 seconds.

The code “C02” appears on the display.

To return to the normal operation mode press the ON and SEL keys again for at least 4 sec..

REMOTE CONTROL TERMINAL BOARD

The remote control terminal allows for implementation of the REPO function (Remote Emergency Power Off) and to remotely switch on/off the UPS.

The UPS is provided by the manufacturer with the REPO terminals short-circuited. For installation remove the short circuit and connect to the device's normally closed contact
In case of an emergency, if the stop device is used, the REPO control is opened and the UPS goes into stand-by mode and the load is completely disconnected.

Attention: before restarting the UPS, reset the stop device.

The circuitry of the remote control terminal board is self-powered with SELV circuits. Therefore, an external voltage supply is not required. When a contact is closed, a maximum current of 15mA circulates.
All connections with the remote control terminal board are made through a cable which guarantees a double insulation connection.

Logic of the connections:

- PIN 1-2 REPO

The function is activated when the contact is opened.

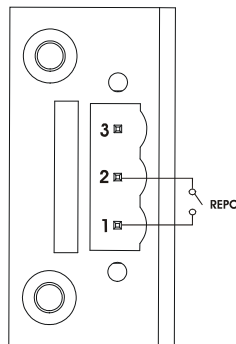

- PIN 2-3 REMOTE ON, REMOTE ON/OFF

The feature is activated by closing the contact.

Set by default as REMOTE ON, also configurable as REMOTE ON/OFF using **UPStools** software

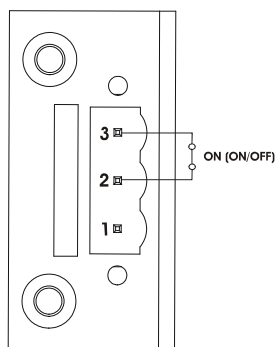

SOFTWARE

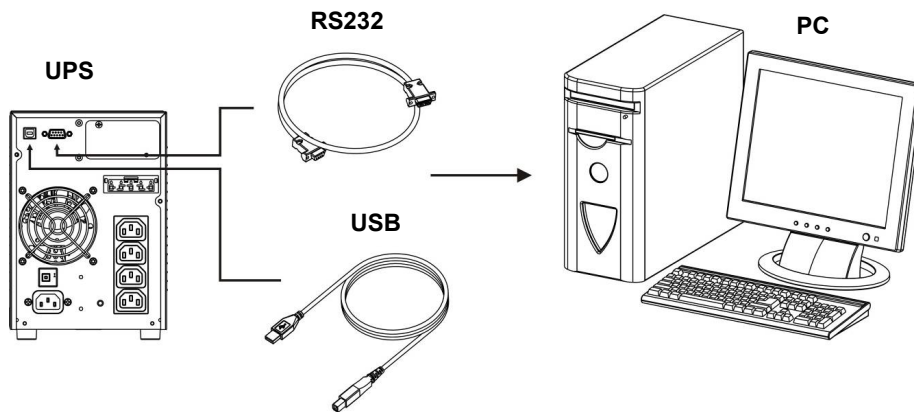

MONITORING AND CONTROL SOFTWARE

The **PowerShield³** software guarantees effective, intuitive UPS management, displaying all the most important information such as input voltage, applied load, battery capacity. It is also able to perform shutdown operations and send e-mails, text messages and network messages automatically when certain events, selected by the user, occur.

INSTALLATION OPERATIONS

- 1) Connect one of the UPS's communication ports to one of the PC's communication ports using the cable supplied.
- 2) Download the software from the web site **www.riello-ups.com** selecting the specific operating system.
- 3) Follow the installation program instructions.
- 4) For more detailed information please read the user manual which can be downloaded from **www.riello-ups.com**.

CONFIGURATION SOFTWARE

The **UPSTools** software allows the configuration and full display of the status of the UPS via USB or RS232. For a list of possible configurations available to the user, refer to the UPS Configuration paragraph.

INSTALLATION OPERATIONS

- 1) Connect one of the UPS's communication ports to one of the PC's communication ports using the cable supplied.
- 2) Follow the installation instructions shown within the software manual which can be located in the UPSTools directory or downloaded from the web site **www.riello-ups.com**.

CAUTION:

If the RS232 communication port is used, it is not possible to communicate with the USB port and vice versa.

It is advisable to use a cable which is shorter than 3 metres for communication with the UPS.

To obtain additional communication ports with different functions, independent from the standard USB and RS232 ports on the UPS, various accessories are available which can be inserted into the communication card slot.



To check whether new, more up-to-date software versions are available and for more information about the accessories available, consult the website: **www.riello-ups.com**.

UPS CONFIGURATION

The table below illustrates all the possible configurations available to the user in order to best adapt the UPS to individual requirements. It is possible to perform these operations using the Upstools software.

FUNCTION	DESCRIPTION	DEFAULT	POSSIBLE CONFIGURATIONS
Output frequency	Selects the nominal output frequency	Auto	<ul style="list-style-type: none"> • 50 Hz • 60 Hz • Auto: automatic learning of the input frequency
Output voltage	Selects the nominal output voltage	230V	220 - 240 in 1V steps
Operating mode	Selects one of the 4 different operating modes	ON LINE	<ul style="list-style-type: none"> • ON LINE • ECO • SMART ACTIVE • STAND-BY OFF (MODE 1)
Bypass operation	Selects the mode of use of the bypass line	Normal	<ul style="list-style-type: none"> • Normal • Disabled with input/output synchronisation • Disabled without input/output synchronisation
Power-off due to minimum charge	Automatic UPS power-off in battery operation mode if the charge is lower than 5%	Disabled	<ul style="list-style-type: none"> • Enabled • Disabled
Autonomy limit	Maximum battery operation time	Disabled	<ul style="list-style-type: none"> • Disabled (complete battery discharge) • (1 - 65000) sec. in 1 sec steps
Battery low warning	Estimated autonomy time remaining for the battery low warning	3 min.	(1 - 255) min. in 1 min steps
Battery test	Interval of time for the automatic battery test	40 hours	<ul style="list-style-type: none"> • Disabled • (1 - 1000) h in 1 hour steps
Maximum charge alarm threshold	Selects the user overcharge limit	Disabled	<ul style="list-style-type: none"> • Disabled • (0 - 103) % in 1% steps
Input frequency tolerance range	Selects the permitted range for the input frequency for switching to the bypass and for the synchronisation of the output	± 5%	(±3 - ±10) % in 1% steps

* For configurations of the $F_{out} = 50, 60\text{Hz}$ or if the sync is disabled with the input, the UPS downgrades the output power.

FUNCTION	DESCRIPTION	DEFAULT	POSSIBLE CONFIGURATIONS
Bypass voltage thresholds	Selects the permitted voltage range for switching to the bypass	Low: 180V High: 264V	<ul style="list-style-type: none"> • Low: 180 - 200 in 1V steps • High: 250 - 264 in 1V steps
Bypass voltage threshold for ECO	Selects the permitted voltage range for operation in ECO mode	Low: 200V High: 253V	<ul style="list-style-type: none"> • Low: 180 - 220 in 1V steps • High: 240 - 264 in 1V steps
Intervention sensitivity for ECO	Selects the intervention sensitivity during operation in ECO mode	Normal	<ul style="list-style-type: none"> • Low • Normal • High
Power-on delay	Waiting time for automatic switching back on after mains power returns	5 sec.	<ul style="list-style-type: none"> • Disabled • (1 - 255) sec. in 1 sec steps
Remote power-on/off function	Select the feature associated with the remote control terminal board.	Pin 1-2 REPO Pin 2-3 Remote ON	<ul style="list-style-type: none"> • Pin 1-2 REPO • Pin 2-3 Remote ON, Remote ON/OFF

COMMUNICATION PORTS

On the back of the UPS (see *UPS Views*), the following communication ports are present:

- RS232 connector
- USB connector
- Expansion slot for additional communication cards

RS232 CONNECTOR

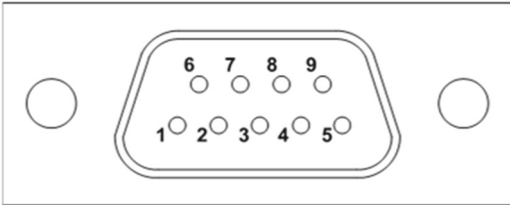
RS232 CONNECTOR		
		
PIN #	SIGNAL	NOTES
1	Programmable output *: [default: UPS in lock]	(*) Opto-isolated contact max. +30Vdc / 35mA. These contacts can be associated with other events using the software provided For further information about interfacing with the UPS, refer to the manual provided
2	TXD	
3	RXD	
5	GND	
6	Power supply DC ($I_{max} = 20mA$)	
8	Programmable output *: [default: low battery pre-alarm]	
9	Programmable output *: [default: battery operation]	

COMMUNICATION SLOT

The UPS is equipped with an expansion slot for optional communication cards (see figure on right) which allows the device to communicate using the main communication standards.

Some examples:

- Second RS232 and USB port
- Serial duplicator
- Ethernet network card with TCP/IP, HTTP and SNMP protocols
- JBUS / MODBUS protocol converter card
- PROFIBUS protocol converter card
- Card with relay isolated contacts

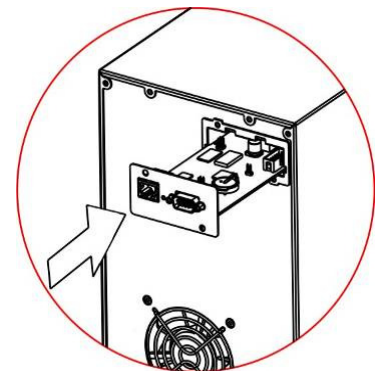

To check whether further accessories are available, consult the website: www.riello-ups.com

TROUBLESHOOTING

Irregular UPS operation is most likely not an indication of a fault but due to simple problems or distraction. It is therefore advisable to consult the table below carefully as it summarises information which is useful for solving the most common problems.

PROBLEM	POSSIBLE CAUSE	SOLUTION
THE DISPLAY DOES NOT LIGHT UP	ON/OFF SWITCH NOT PRESSED	Press the ON/OFF switch on the front panel.
	MAIN CONNECTION CABLE MISSING	Check that the power cable is connected correctly.
	NO MAINS VOLTAGE (BLACKOUT)	Check that the power reaches the socket where the UPS is connected (try it with a table lamp, for example).
	INTERVENTION OF THE INPUT CIRCUIT BREAKER	If present, reset the circuit breaker by pressing the button on the back of the UPS. CAUTION: Check that there is no output overload to the UPS.
THE DISPLAY IS ON BUT THE LOAD IS NOT POWERED	THE UPS IS IN STAND-BY MODE	Press the "ON" button on the front panel to power the loads.
	THE STAND-BY OFF MODE IS SELECTED	It is necessary to change mode. The STAND-BY OFF (emergency power supply) mode, in fact, only powers the loads in the event of a blackout.
	NO CONNECTION TO THE LOAD	Check the connection to the load.
THE UPS IS OPERATING FROM THE BATTERY DESPITE THE PRESENCE OF MAINS VOLTAGE	THE INPUT VOLTAGE IS OUTSIDE THE PERMITTED TOLERANCE RANGE FOR MAINS OPERATION	Problem with the mains. Wait until the input mains voltage returns within the tolerance range. The UPS will automatically return to mains operation.
	INTERVENTION OF THE INPUT CIRCUIT BREAKER	If present, reset the circuit breaker by pressing the button on the back of the UPS. CAUTION: Check that there is no output overload to the UPS.
THE UPS DOES NOT COME ON AND THE DISPLAY SHOWS THE CODE: A06, A08	THE TEMPERATURE OF THE UPS IS LOWER THAN 0°C	Check the temperature of the environment in which the UPS is located; if it is too low, bring it past the minimum threshold (0°C).
THE DISPLAY SHOWS THE FOLLOW CODES: L10, L11, F11	INPUT RELAY FAULTY	Switch off and disconnect the UPS from the power supply and contact the support centre.
THE DISPLAY SHOWS THE FOLLOW CODE: L02	CONTROL CARD IS NOT INSERTED CORRECTLY	Switch off and disconnect the UPS from the power supply and contact the support centre.

PROBLEM	POSSIBLE CAUSE	SOLUTION
THE BUZZER SOUNDS CONTINUOUSLY AND THE DISPLAY SHOWS ONE OF THE FOLLOWING CODES: A54, F50, F51, F52, F55, L50, L51, L52	THE LOAD APPLIED TO THE UPS IS TOO HIGH	Reduce the load to within the threshold of 100% (or user threshold in the case of code A54). If the display shows a lock: remove the load and switch the UPS off and back on again.
THE DISPLAY SHOWS THE FOLLOW CODE: A61	REPLACE THE BATTERIES	Contact the support centre for battery replacement.
THE DISPLAY SHOWS THE FOLLOW CODE: A62	BATTERIES MISSING OR BATTERY BOX MISSING OR NOT CONNECTED	On the versions with an additional battery charger in place of the batteries, check that the Battery Box is inserted and connected to the UPS correctly.
THE DISPLAY SHOWS THE FOLLOW CODE: A63	THE BATTERIES ARE FLAT; THE UPS IS WAITING FOR THE BATTERY VOLTAGE TO EXCEED THE SET THRESHOLD	Wait until the batteries have recharged or force power-on manually by holding down the "ON" button for at least 2 seconds.
THE BUZZER SOUNDS CONTINUOUSLY AND THE DISPLAY SHOWS ONE OF THE FOLLOWING CODES: F03, F05, F07, F13, F21, F40, F41, F42, F43	THE UPS IS MALFUNCTIONING; IT WILL PROBABLY LOCK SOON	If possible, disconnect the power to the load, switch the UPS off and back on again; if the problem occurs again, call the support centre.
THE BUZZER SOUNDS CONTINUOUSLY AND THE DISPLAY SHOWS ONE OF THE FOLLOWING CODES: F04, L04	THE TEMPERATURE OF THE DISSIPATORS INSIDE THE UPS IS TOO HIGH	Check that the temperature of the environment in which the UPS is located does not exceed 40°C.
THE BUZZER SOUNDS CONTINUOUSLY AND THE DISPLAY SHOWS ONE OF THE FOLLOWING CODES: F53, L53	THERE IS A FAULT ON ONE OR MORE OF THE UTILITIES POWERED BY THE UPS	Disconnect all the utilities, switch the UPS off and back on again, reconnect the utilities one at a time to identify which one is faulty.
THE BUZZER SOUNDS CONTINUOUSLY AND THE DISPLAY SHOWS ONE OF THE FOLLOWING CODES: F60, L03, L05, L07, L13, L20, L21, L40, L41, L42, L43	THE UPS IS MALFUNCTIONING	If possible, disconnect the power to the load, switch the UPS off and back on again; if the problem occurs again, call the support centre.
THE DISPLAY SHOWS ONE OF THE FOLLOWING CODES: C01, C02, C03	A REMOTE COMMAND IS ACTIVE	If unwanted, check the status of the command inputs on any optional contact card.
THE DISPLAY SHOWS C02	THE MANUAL BYPASS FUNCTION IS ACTIVE	To exit manual bypass mode, press the ON+SEL buttons at the same time for at least 4 seconds.

ATTENTION:



The UPS in case of a permanent failure will be not able to supply the load. To ensure total protection of your equipment we suggest you install an ATS device (Automatic Transfer Switch) or an external automatic by-pass.

For more information visit www.riello-ups.com

ALARM CODES

Using a sophisticated self-diagnosis system, the UPS is able to check its own status and any anomalies and/or faults which may occur during normal operation and display them on the display panel. If there is a problem, the UPS signals the event by showing the code and the type of active alarm on the display (FAULT and/or LOCK).

FAULT

FAULT alerts can be divided into three categories:

- **Anomalies:** these are “minor” problems which do not cause the lock of the UPS but reduce performance or prevent certain functions from being used.

CODE	DESCRIPTION
A06	Sensor1 temperature under 0°C
A08	Sensor2 temperature under 0°C
A54	Load percentage greater than the user threshold set
A61	Replace batteries
A62	Batteries missing or Battery Box missing or not connected
A63	Waiting for battery charging

- **Alarms:** these are more critical problems than anomalies because, if they persist, they could cause the UPS to lock in a very short time.

CODE	DESCRIPTION
F03	Incorrect auxiliary power supply
F04	Dissipator overtemperature
F05	Temperature sensor1 faulty
F07	Temperature sensor2 faulty
F11	Input relay faulty
F13	Capacitor pre-charge failed
F21	Capacitor bank overvoltage
F40	Inverter overvoltage
F41	Continuous output voltage
F42	Incorrect inverter voltage
F43	Inverter undervoltage
F50	Overload: load > 103%
F51	Overload: load > 110%
F52	Overload: load > 150%
F53	Short circuit
F55	Waiting for load reduction to return to inverter
F60	Battery overvoltage

- **Active commands:** Indicates the presence of an active remote command.

CODE	DESCRIPTION
C01	Remote control 1 (Switch On/Off)
C02	Remote control 2 (load on bypass or manual bypass command)
C03	Remote control 3 (Switch On/Off)
C04	Battery test in progress

LOCK

LOCK alerts are normally preceded by an alarm signal and their scale leads to the power-off of the inverter and the load being powered by the bypass line (this procedure is excluded for locks due to serious, persistent overloads and short circuits).

CODE	DESCRIPTION
L02	Control card is not inserted correctly
L03	Incorrect auxiliary power supply
L04	Dissipator over temperature
L05	Temperature sensor1 faulty
L07	Temperature sensor2 faulty
L10	Input fuse broken or input relay stuck (does not close)
L11	Input relay faulty
L13	Capacitor pre-charge failed
L20	Capacitor bank undervoltage
L21	Capacitor bank overvoltage
L40	Inverter overvoltage
L41	Continuous output voltage
L42	Incorrect inverter voltage
L43	Inverter undervoltage
L50	Overload: load > 103%
L51	Overload: load > 110%
L52	Overload: load > 150%
L53	Short circuit

TECHNICAL DATA

UPS MODELS	SEP 700	SEP 1000 SEP 1000 ER	SEP 1500	SEP 2200 SEP 2200 ER	SEP 3000 SEP 3000 ER
------------	---------	-------------------------	----------	-------------------------	-------------------------

INPUT

Nominal voltage	[Vac]	220 - 230 - 240				
Maximum operating voltage	[Vac]	300				
Nominal frequency	[Hz]	50 - 60				
Nominal current (1)	[A]	3.6	5 / 5.8	7	10.5 / 12	14 / 15.5

BATTERY

Recharge time (standard versions)	[h]	< 4h for 80% of the load				
Expandability and nominal voltage of the Battery Box		Not expandable	36Vdc	Not expandable	72Vdc	72Vdc
Charging current (for ER versions only)		Not applicable	6A	Not applicable	6A	6A

OUTPUT

Nominal voltage (4)	[Vac]	Selectable: 220 / 230 / 240				
Frequency (2)	[Hz]	Selectable: 50, 60 or auto sensing				
Nominal power	[VA]	700VA	1000VA	1500VA	2200VA	3000VA
Nominal power	[W]	630W	900W	1350W	1980W	2700W
Overload: 100% < load < 110%		Bypass line available:		activates the bypass after 2 seconds locks after 120 seconds		
		Bypass line not available:		locks after 60 seconds		
Overload: 110% < load < 150%		Bypass line available:		activates the bypass after 2 seconds		
		Bypass line not available:		locks after 4 seconds locks after 4 seconds		
Overload load > 150%		Bypass line available:		activates the bypass instantly locks after 1 second		
		Bypass line not available:		locks after 0.5 seconds		

OTHER

Leakage current to earth	[mA]	< 1,5mA			< 2mA	
Ambient temperature (3)	[°C]	0 – 40				
Humidity		< 90% without condensation				
Protection devices		excessively low batteries - overcurrent - short circuit - overvoltage - undervoltage - circuit breaker				
Dimensions W x D x H	[mm]	158 x 422 x 235			190 x 446 x 333	
Weight	[kg]	11	13	14	26	28
Weight (for ER versions only)	[kg]	Not applicable	7	Not applicable	14	15

For more details please consult the web site

- (1) at nominal load, nominal voltage of 220 Vac, battery charging
- (2) If the mains frequency is within $\pm 5\%$ of the selected value, the UPS is synchronised with the mains. If the frequency is out of the tolerance range or operating from the battery, the frequency is the one selected $\pm 0.1\%$
- (3) 20 - 25 °C for longer battery life
- (4) To keep the output voltage within the indicated range of precision, recalibration may be necessary after a long period of operation

BATTERY BOX		JSEP036-NPA-	JSEP036-NPM-	JSEP072-NPA-	JSEP072-NPM-
Nominal battery voltage	[Vdc]	36Vdc		72Vdc	
Dimensions W x D x H	[mm]	158 x 422 x 235		190 x 446 x 333	
Weight	[kg]	14	21	27	41

The "-" symbol replaces an alphanumeric code for internal use.



www.riello-ups.com

RPS SpA – *Riello Power Solutions*
Viale Europa, 7
37045 Legnago (VR)
Italy

0MNSEP700RUENUG